

User and maintenance manual for stoves with touch remote

ATENA V RV 120 TOUCH VITTORIA V

Ravelli[®]
il fuoco intelligente

SAVE THESE INSTRUCTIONS

Please read this entire manual before installation and use of this pellet fuel-burning room heater. Failure to follow these instructions could result in property damage, bodily injury or even death. Contact local building or fire officials about restrictions and installation inspection requirements in your area. Contact local authorities to see if a permit must be obtained before installation.

ASTM E 1509-12 • UL 1482 - 11 • ULC S627-00 • Oregon Administration Rules 814-23-909 • Mobile Home Approved

Rev.1 MP0461

Index

1. Introduction.....	pag 4
2. Safety information.....	pag 5
3. General.....	pag 6
4. Safety devices.....	pag 10
5. Technical features.....	pag 10
6. Positioning, assembly and installation	pag 10
6.1 Minimum distance from combustible material.....	pag 10
6.2 Environment of use	pag 11
6.3 Mobile Home Requirements.....	pag 11
6.4. Examples of installation.....	pag 12
7. Preliminary operations.....	pag 16
7.1 Description of the functioning and symbology of the display.....	pag 16
8. Description of the functions.....	pag 19
9. Description of alarms.....	pag 34
10. The electrical wiring diagram.....	pag 36
11. Maintenance.....	pag 37
12. Guarantee.....	pag 38

1. Introduction

Important:

Please read this manual carefully. It describes all the phases necessary for perfect functioning of the stove.

Warning:

The regulations on installation and operation in this manual may differ from the regulations in force locally. In this case, the indications of the competent local authorities must always be followed. The drawings shown in this manual are indicative and not to scale.

Information:

The packaging that we have used offers good protection against any damage due to transport. Always check the stove immediately after delivery: in the event of any damage, please inform your Ravelli dealer immediately.

Description of use and maintenance manual

With this use and maintenance manual, Ravelli wishes to provide the user with all the information on safety in using the stove, in order to avoid damage to persons or things or parts of the stove. Please read this manual carefully before use and any work on the product.

WARNINGS

Ravelli stoves are manufactured taking care even on the individual components in order to protect both the user and the installer from any accidents.

The authorized personnel, after any work on the product, should therefore always pay special attention to the electrical connections.

Installation must be performed by authorized personnel, who must give the purchaser a declaration of conformity of the appliance, and who will assume all responsibility for the final installation and consequent good functioning of the product installed. It is also necessary to take into consideration all the laws and national, regional, provincial and local regulations present in the country in which the appliance has been installed. In the event of failure to respect these precautions, Ravelli declines all responsibility.

This instruction manual is an integral part of the product: please make sure that it is always with the stove, including in the case of transfer to another owner or user, or transfer to another place. In the case of its damage or loss, please request another copy from the Technical service.

This stove must be used for the purpose for which it has been specifically manufactured. Do not use the appliance as an incinerator or in any way other than that for which it was designed. All contractual and tort responsibility of the manufacturer is excluded for damage caused to persons, animals or things, due to errors of installation, maintenance regulation or improper use. No other fuel except the pellets must be used. Do not use liquid fuels.

After having removed the packaging, please make sure that the contents are complete and intact.

All the electrical components that make up the stove must be replaced with original spare parts exclusively from an authorized technical assistance centre. **Maintenance of the stove must be performed at least once a year, planning it in time with the technical assistance centre.** Do not make any unauthorized modification to the appliance.

For safety reasons, please remember that:

- the stove must not be used by children or disabled people without assistance;
- do not touch the stove when barefoot or when any parts of the body are wet;
- the safety devices or adjustment devices must not be modified without the authorization or instructions of Ravelli.

The stove, especially the external surfaces, reaches very high temperatures when it is in operation; take care when touching it to avoid burns.

The stove has been designed to function in any climatic condition; in the event of particularly adverse conditions (wind, freezing), safety systems could switch off the stove.

If this occurs, contact the technical assistance and, in any case, do not disable the safety systems.

Thank you

Dear Customer,

We would like to thank you and congratulate you on the excellent choice you have made.

With the Ravelli stove, you will see that quality and economy can go hand in hand, offering excellent performances with limited consumption and being totally practical. Please find below some suggestions, which we would like to give you, to obtain the most from your stove and to fully enjoy all the advantages that it can give you.

Through this, we want to be close to our customers to offer the maximum technical support to all those who use our technology.

Ravelli thanks you for your confidence
and wishes you happy times in the company
of your pellet stove.

2. Safety information

The stove must be installed and tested by specialized personnel instructed by the Ravelli. Please read this use and maintenance manual before installing and putting the stove into operation!

If you require further information, please contact your Ravelli dealer.

IMPORTANT

- The place of installation of the stove must comply with local, national and Federal regulations.
- The stove must be fuelled only with quality pellets with a diameter of 6 mm as described in the specific chapter.

The stove cannot operate with traditional wood

The stove must not be used as an incinerator. FIRE HAZARD!!!

- **Installation, the electrical connections, checking the functioning and maintenance must be performed by qualified and authorized personnel.**

- **Improper installation or poor maintenance (not compliant with what is shown in the following manual) may cause damage to persons and things. In this condition, Ravelli is relieved of all civil or criminal responsibility.**

- Before connecting the stove electrically, the connection of the exhaust tubes must be completed (specifically for pellet stoves, not made from aluminium) with the flue.

- The protection grille inside the pellet hopper must never be removed.

- There must be sufficient circulation of air in the room where the stove is installed.

- Never open the door of the stove whilst it is functioning. **FIRE HAZARD!!!**

- **The stove must not be used with the door open or with the glass broken. FIRE HAZARD!!!**

- When the stove is operating, the surfaces, the glass, the handle and the pipes become overheated: during functioning, these parts must only be touched with the adequate protection.

- **Do not light the stove without having first performed the daily inspection as described in the MAINTENANCE chapter of this manual.**

- **Do not place any washing on the stove to dry. Keep clothes and similar at a suitable distance from the stove. FIRE HAZARD!!!**

-DO NOT INSTALL A FLUE DAMPER

-DO NOT CONNECT THIS UNIT TO A CHIMNEY FLUE SERVING ANOTHER APPLIANCE

- Attachment and securement of the exhaust venting system to the product and to each adjoining section. All joints for connector pipe shall be required to be fastened with at least three screws. If vented horizontally, joints shall be made gaslight in a manner that shall be specified.

- Perform regular inspection, maintenance, and cleaning of the chimney and chimney connector

- **Disposal of Ashes:** Ashes should be placed in a metal container with a tight fitting lid. The closed container of ashes should be placed on a noncombustible floor or on the ground, well away from all combustible materials, and moved outdoors immediately. If the ashes are disposed of by burial in soil or otherwise locally dispersed, they should be retained in the closed container until all cinders have thoroughly cooled. Other waste shall not be placed in this container.

- **Caution against the storage or use of flammable liquids, as follows:** Never use gasoline, gasoline-type lantern fuel, kerosene, charcoal lighter fluid, or similar liquids to start or 'freshen up' a fire in this heater. Keep all such liquids well away from the heater while it is in use.

- Creosote - Formation and Need for Removal

When wood is burned slowly, it produces tar and other organic vapors, which combine with expelled moisture to form creosote. The creosote vapors condense in the relatively cool chimney flue of a slow-burning fire. As a result, creosote residue accumulates on the flue lining. When ignited this creosote makes an extremely hot fire

The exhaust venting system should be inspected at least once every two months during the heating season to determine if a creosote buildup has occurred.

If creosote has accumulated it should be removed to reduce the risk of a chimney fire.

- Scrupulously follow the maintenance programme.

- Do not switch off the stove by disconnecting the electricity mains supply.

- Do not clean the stove until the structure and the ashes have cooled down completely.

- Carry out all operations in maximum safety and tranquillity.

- Copy with exhaust venting system termination requirements including location restrictions to air inlets, distances from windows, doors, and air inlets and distance to combustible materials.

- do not connect to or use in conjunction with any air distribution ductwork

- hot while in operation. Keep children, clothing and furniture away. Contact may cause skin burns.

- The type of chimney shall be suitable for solid fuel and the chimney connector must be in good condition and kept clean.

- Establish a routine for the fuel, pellet burner and fring technique. Check daily for creosote build-up until experience shows how often you need to clean to be safe. Be aware that the hotter the fire the less creosote is deposited and weekly cleaning may be necessary in mild weather even though monthly cleaning may be enough in the coldest months. Contact your local or fire authority for information on how to handle a chimney fire. Have a clearly understood plan to handle a chimney fire.

- Keep firing and deashing doors closed and maintain all seals in good conditions.

- Do not strike or slam shut the door, the glass can brake. The glass shall be cleaned only when cold, do not clean a hot glass.

Use a dry cloth with normal glass detergent, do not use any abrasive cleaner.

- The type of chimney shall be suitable for solid fuel and the chimney connector must be in good condition and kept clean.

- When this room heater is not properly installed, a house fire may result. To reduce the risk of fire, follow the installation instructions. Contact local building or fire officials about restrictions and installation inspection requirements in your area.

- This room heater must be connected to a chimney complying with the requirements for type HT chimneys in the standard UL 103 or a code-approved masonry chimney with a flue liner.

- This wood heater needs periodic inspection and repair for proper operation. It is against federal regulations to operate this wood heater in a manner inconsistent with operating instructions in this manual.

- This wood heater has a manufacturer-set minimum low burn rate that must not be altered. It is against federal regulations to alter this setting or otherwise operate this wood heater in a manner inconsistent with operating instructions in this manual.
- This heater is designed to burn wood pellet only.DO NOT BURN ANY OTHER FUEL. Burning other materials may result in release of toxic fumes or render the heater ineffective and cause smoke.
- Do not overfire. Attempts to achieve heat output rates that exceed heater design specifications can result in permanent damage to the heater.
- Flues gases contain carbon monoxide (CO), it is recommended to install smoke monitors and CO monitors for areas that are expected to generated CO. Inspect the the chimney to minimize visible emissions.
- Soot and Flyash: Formation and Need for Removal—The products of combustion will contain small particles of flyash. The flyash will collect in the exhaust venting system and restrict the flow of the flue gases. Incomplete combustion, such as occurs during startup, shutdown, or incorrect operation of the room heater will lead to some soot formation which will collect in the exhaust venting system. The exhaust venting system should be inspected at least once every year to determine if cleaning is necessary.

3. General

The Stove must only operate in rooms. As it is controlled by an electronic board, combustion is completely automatic and controlled and the control unit regulates the ignition phase, 5 levels of power and the switching off phase, guaranteeing safe functioning.

Most of the ashes produced by the combustion of the pellets fall into the collection drawer.

However, always check the fire pot every day, as not all pellets have high standards of quality and could leave residue that is difficult to remove.

The glass has a special air circulation for self-cleaning. However, a slight greyish film cannot be avoided after a few hours of functioning.

As already mentioned earlier, pellets with a diameter of 6 mm must be used with the stove.

3.1 Responsibility

Ravelli declines all responsibility, both civil and criminal, with the delivery of this manual, for any accidents deriving from partial or total failure to observe the instructions it contains,

Ravelli declines all responsibility deriving from the improper use of the stove, from its incorrect use by the user, by unauthorized modifications and/or repairs or from the use of spare parts which are not original.

The manufacturer declines all direct civil or criminal responsibility due to:

- poor maintenance
- failure to observe the instructions in the manual
- use not compliant with the safety instructions
- installation that is not compliant with the regulations in force in the country.
- installation by personnel who are not qualified or authorized
- modifications and repairs that are not authorized by the manufacturer
- use of spare parts that are not original
- exceptional events

3.2 Compliance status

This manual describes the installation and operation of the Ravelli, Vittoria V, Atena V and RV 120 Touch wood pellet heater. This heaters meet the 2020 U.S. Environmental Protection Agency’s wood pellet emission limits for wood heaters sold after May 15th 2015. Under specific test conditions this heater has been shown to deliver heat at rates ranging from 12900 to 37000 Btu/hr.

	Emission Rate (g/hr)	Heating Efficiency (% Overall)	1st hour Emission Rate (g/hr)	CO emission (g/hr)
Vittoria V	0.6	79.25	2.19	2.8
Atena V	0.6	79.25	2.19	2.8
RV 120 Touch	0.6	79.25	2.19	2.8

3.3 Spare parts

Use original spare parts only. Do not use any substitute material. Do not wait for the components to be worn before replacing them. Replace a worn component before it is completely broken to prevent any accidents caused by the sudden breakage of components, perform the periodic maintenance checks as described in the dedicated chapter. Removal of broken or damaged components shall be only done by authorized technical service.

3.3.1 Glass and gasket replacement

Use only ceramic type glass. To replace the glass the door needs to be disassembled according to the below drawing.

Vittoria V - Atena V - RV 120 Touch

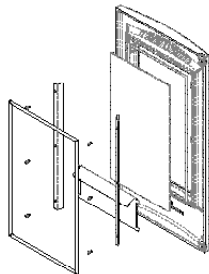

Ceramic glass dimensions:
272 x 510 mm (10.71" x 20.08")
thickness 5mm (0.20")

Glass ribbon trecotee gasket:
8 mm x 3 mm (0.31" x 0.12")
L1540 mm (60.63")

Door tricovet gasket:
diam. 10 mm (0.39")
L1680 mm (66.14")

3.4. Majolica finishes

Due to the special hand finish of the majolica surface imperfections such as shadowing may occur. Those are details that make every majolica one of its kind. As it is a delicate material, please handle with care whilst cleaning and avoid blows as sudden breakage may occur. Please also take care when loading the hopper (Ed.'s note; tank containing the pellets) with the bag of pellets: do not place it on the stove!

3.5. What are the wood pellets

The wood pellets are made from sawdust and wood shavings produced in joiners' shops. The material used cannot contain any foreign substance such as glue, varnish or synthetic substances.

Subjecting it to high pressure, the wood is pressed through a plate with holes and due to the high pressure the sawdust is heated activating the natural binders of the wood. Thus, the pellets keep their shape even without the addition of bonding substances. The density of the wood pellet varies according to the type of wood and can be 1.5 – twice greater than that of natural wood.

The diameter of the cylindrical rods is 6 mm and their length can vary between 10 and 40 mm.

Their real weight is greater than 650 kg/m³. Due to the low content of water (<10%) they have a high energy content.

The standards ISO 17225-2:2014 define the quality of the pellets:

Length:	< 40 mm
Diameter:	6 mm approx.
Real weight:	> 600 kg/m ³
Lower heating value:	≥ 16,5 MJ/kg (≥ 7100 BTU/lb)
Residual humidity:	< 10 %
Ashes:	< 1.2 %
Specific weight:	>1000 kg/m ³

Do not put the bag of pellets on the ceramic parts during the loading operations.



Pic.1



Pic.2

The pellets must be transported and stored in a dry place. They swell on contact with damp, and cannot be used. They must always be protected from the damp both during transport and in storage. Do not place such fuel within the space heater installation clearances or within the space required for charging and ash removal.

3.6. The components of the stove

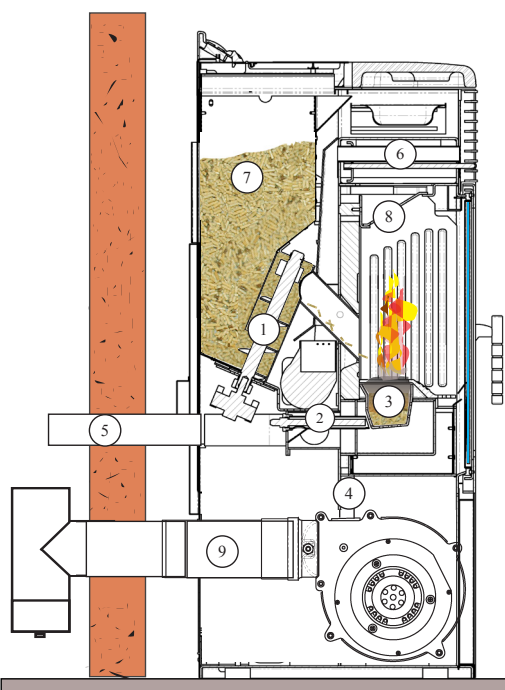

1. pellet loading screw
2. electrical igniter
3. combustion fire pot
4. tube for passage of smoke
5. air intake tube
6. stainless steel heat exchanger
7. pellet hopper
8. baffle
9. smoke exhaust tube

This drawing shows the internal parts of a pellet stove. By filling the hopper (7), the pellets are loaded into the fire pot (3) through the loading screw (1). Ignition is by means of the electrical igniter (2), which overheats the air from the special entrance (5) which on contact with the pellets will allow the development of the flame. At this point the exhaust smoke is deviated towards the stainless steel exchanger (6) and through the smoke extraction tube (4) it is released into the flue, through the connection with the smoke exhaust pipe. (9).

3.7. The combustion

The combustion is a chemical reaction between fuel and oxidizer. The result of this reaction is the heat. The three elements that are required for the combustion are:

- Fuel (pellet)
- oxidizer (oxygen available in the air)
- Ignition (heat of embers or electrical ignitor)

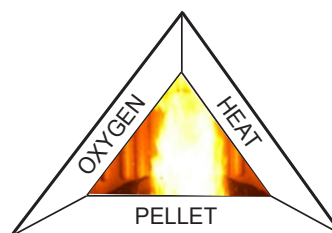

To get the combustion, the combustible and the carburant must be available in a correct proportion.

The reaction between combustible and carburant is made by an external starter. The start can be made by the hot reaction or by a sparkle.

The combustion is NOT CORRECT, the flame is too tight with too much incandescent pellet in the firepot.

Adjust the Set pellet/air reducing the air percentage (from 0 up to -5); in the vent this is not enough to get a proper flame, increase the loading quantity of the pellet (from 0 up to +5) to reach the flame condition shown in picture 3.



Pic. 1

INCORRECT combustion, flame too drawn, in “blowtorch” style with a high quantity of incandescent pellets coming out of the grate. Correct the pellet/air set by reducing the percentage of air (from 0 to -5); if not sufficient, also increase the percentage of falling pellets (from 0 to +5) to arrive to the condition in Figure 3.

If the changes made to the settings do not bring the stove to the right combustion conditions in Figure 3, contact the Technical Support Centre.



Pic. 2

INCORRECT combustion, “spring” flame in “wood stove” style with high quantity of pellets not burning on the grate. Firstly, check the door is closed and the ash pan. Secondly, correct the pellet/air set by increasing the percentage of air (from 0 to +5); if not sufficient, also reduce the percentage of falling pellets (from 0 to -5) to arrive to the condition in Figure 3.

If the changes made to the settings do not bring the stove to the right combustion conditions in Figure 3, contact the Technical Support Centre.



Pic. 3

The combustion IS CORRECT, full flame yellow/white and minimum quantity of pellet in the firepot.

The combustion is fine and no ad.

The picture 3 shows a flame done with a stove working at power P5.

4. Safety devices

The stove is fitted with sophisticated safety systems so that, in the case of breakage of one of the individual parts or defects in the flue, no damage will be caused to the stove and the room in which it is installed. In any case, when a problem arises, the pellets stop falling immediately and the “switch off” phase is activated.

The corresponding alarm will be shown on the display. The details can be seen in chapter 9 “DESCRIPTION OF ALARMS”.

5. TECHNICAL FEATURES

	Unit of measurement	Vittoria V	Atena V	RV 120 Touch
Height	Inch	45.7	45.8	45.8
Width	Inch	20.2	21.1	21.1
Depth	Inch	22.4	22.4	22.4
Weight	Lbs	420	420	400
Diameter of smoke exit tube	Inch	3.1	3.1	3.1
Min-max. hourly consumption of pellets	Lbs/h	1.8 - 5.3	1.8 - 5.3	1.8 - 5.3
Supply	V - Hz	120 - 60	120 - 60	120 - 60
Hopper capacity	Lbs	50	50	50
Efficiency *	%	79.25	79.25	79.25
Smoke temperature min - max	°F	200- 415	200- 415	200- 415

*overall heating efficiency is determined using higher heating value of the fuel.

The data shown above are indicative and not binding. Ravelli reserves the right to make any modifications for the purpose of improving the performances of the product.

6. Positioning, assembly and installation

6.1 Minimum distance from combustible material

NOTE: Install vent at clearances specified by the vent manufactures.

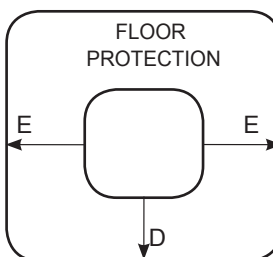
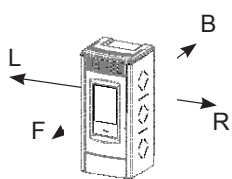

	Vittoria V, RV 120 Touch and Atena V			
	Unit of measurement	CORNER installation	THROUGH THE WALL	Without outside air inlet
Back Wall TO UNIT	Inch/mm	2/ 51	2/ 51	4/ 102
Back Wall TO PIPE	Inch/mm	2,75/ 70	N/A	1/ 25
Side Wall TO UNIT	Inch/mm	2/ 51	2/ 51	2/ 51
Side Wall TO PIPE	Inch/mm	2,75/ 70	11/ 280	11/ 280
Ceiling from floor	Inch/mm	72/1830	72/ 1830	72/ 1830
D=FRONT floor protection	Inch/mm	18/ 457	18/ 457	18/ 457
E = SIDE floor protection	Inch/mm	8 / 203	8 / 203	8 / 203

N.B. The floor protection must extend under the chimney connector and 2 inches (50.8mm) beyond each side

6.2 Environment of use

The positioning of the stove is decisive for a successful and equal heating of the room. Before deciding where to place the stove, the following must be taken into account:

- The stove must be installed on a floor with a sufficient carrying capacity. If the existing building does not meet this requisite, appropriate measures must be taken (i.e. load distribution plate).
- The combustion air cannot be obtained from a garage or from an area without ventilation or exchange of air, but from a free or external space
- The stove must not be installed where there is already another heating appliance without an autonomous air flow (chimney, stove etc.)
- A non-combustible Hearth board 6" from front of unit and 6" from the sides must be installed before unit is placed on the floor.
- Installation is better in a large and central room in the house to ensure maximum circulation of the heat;
- Connection to the main supply is recommended using a grounded outlet (if the cable supplied is not long enough to reach the nearest outlet, use an extension cord with a surge protector);
- The stove must be placed in a position that receives the necessary level of air for appropriate combustion of the pellets (at least 131.23 f³/h must be available), in accordance with installation regulation and local legislations;
- All joints for connector pipe is required to be fastened with at least three screws.
- If vented horizontally joint should be siliconed with hi-temp. silicone and screwed so they are gas tight. (RTU 500 silicone)
- the chimney connector shall not pass through an attic or roof space, closet or similar concealed space, or a floor or ceiling. Where passage through a wall, or partition of combustible construction is desired, the installation shall conform to CAN/CSA-B365.

The stove must be installed and assembled by qualified personnel.

The room must be:

- Prepared for the environmental functioning conditions
- Prepared with an adequate system of evacuation of smoke
- Have a 120V 60 Hz electricity mains supply
- Do not connect this unit to a chimney flue serving another appliance
- Use only UL Listed Type L Vent or Pellet Vent 3" in. I.D. venting system to exhaust. Do not install flue damper in the exhaust system of this unit.
- The chimney connector and each other adjoining section must be firmly attached and secured to the stove.

6.3 Mobile Home Requirements

- Outside air is required
- The heater must be secured to the floor using lag bolts.
- The heater must be grounded to the chassis of the mobile home.
- Installation should be in accordance with the manufactured home.
- When outside air is required, system parts, such as vent sections, supports, spark arresters, rodent screens, etc. must be used.
- The space heater is to be connected to a factory built chimney conforming to CAN/ULC-S629.
- It is important to use all the specified components, do not use other components.
- Installation shall maintain an effective vapour barrier at the location where the chimney or other component penetrates to the exterior of the structure.
- Operating the space heater with open firing doors can cause serious injuries and health damages due to escaping flames or carbon monoxide generation inside the room.
- Adequate ventilation is required to avoid air starvation and icing which can determine an unhealthy indoor environment.
- Do not overfire.
- If the space heater is not correctly installed and operated it can interfere with smoke detectors.

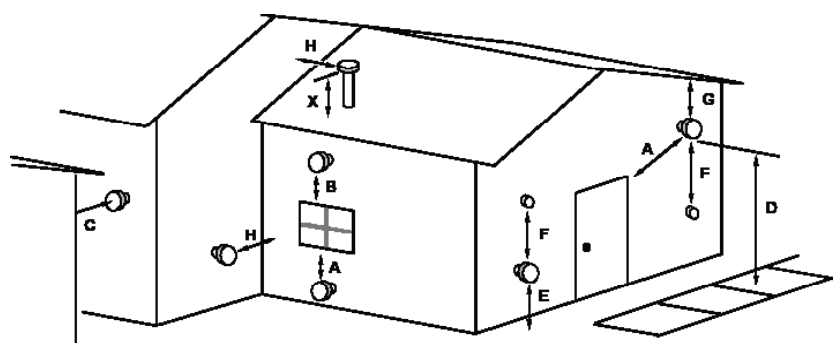

WARNING: Do not install in bedroom

CAUTION: The structural integrity of the mobile home floor, ceiling, walls, roof must be maintained.

Refer to HUD Requirements, CFR 3280, Part 24

NOTE: Install vent at clearances specified by the vent manufactures.

NOTE: Measure clearances to the nearest edge of the exhaust hood.

NOTE: Vent may not terminate in covered walkway or breezeway.

NOTE: If venting horizontally, check your venting specifications for distance pipe should extrude from building.

- A Minimum 4' clearance below or beside any door or window that opens (with outside air installed, 1' below or beside)
- B Minimum 1' clearance below or beside any window that does not open.
- C Minimum 1' clearance above any door or window that opens
- C Minimum 2' clearance from any adjacent building
- D Minimum 7' clearance above any grade when adjacent to public walkways
- E Minimum 2' clearance above any grass, plants, or other combustible materials
- F Minimum 3' clearance from any forced air intake of any other appliance
- G Minimum 2' clearance below eaves or overhangs
- H Minimum 1' clearance horizontally from combustible wall
- X Must be a minimum of 2' above the roof

6.4. Examples of installation

Pic.9

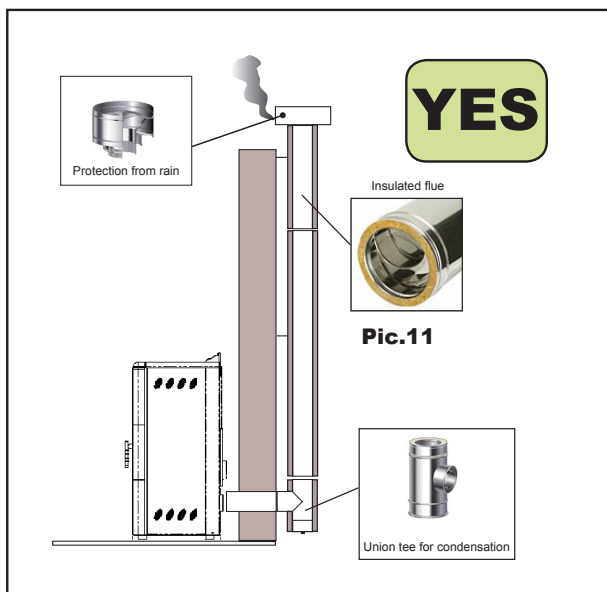

Pic.6

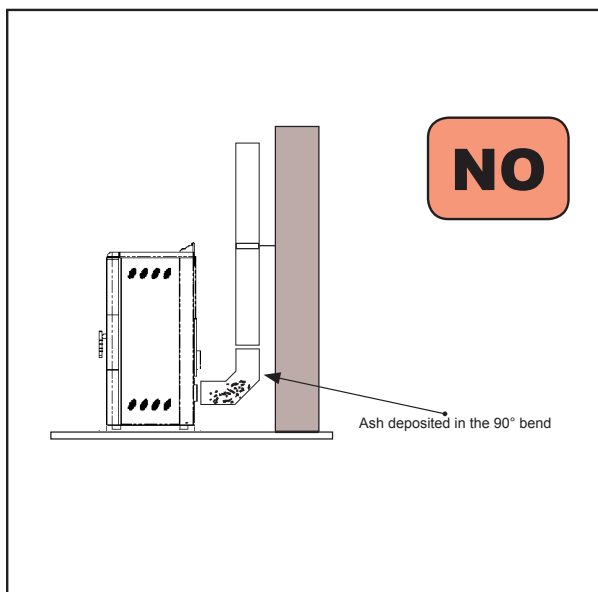

This type of installation (see Pic. 9) requires an insulated flue, as all the smoke pipe has been installed outside the house.

In the lower part of the flue, a union tee has been mounted with an inspection cap.

A 90° bend should not be installed as the first initial piece as the ashes would quickly obstruct the passage of smoke, causing problems for the draught of the flue. (See Pic. 6).

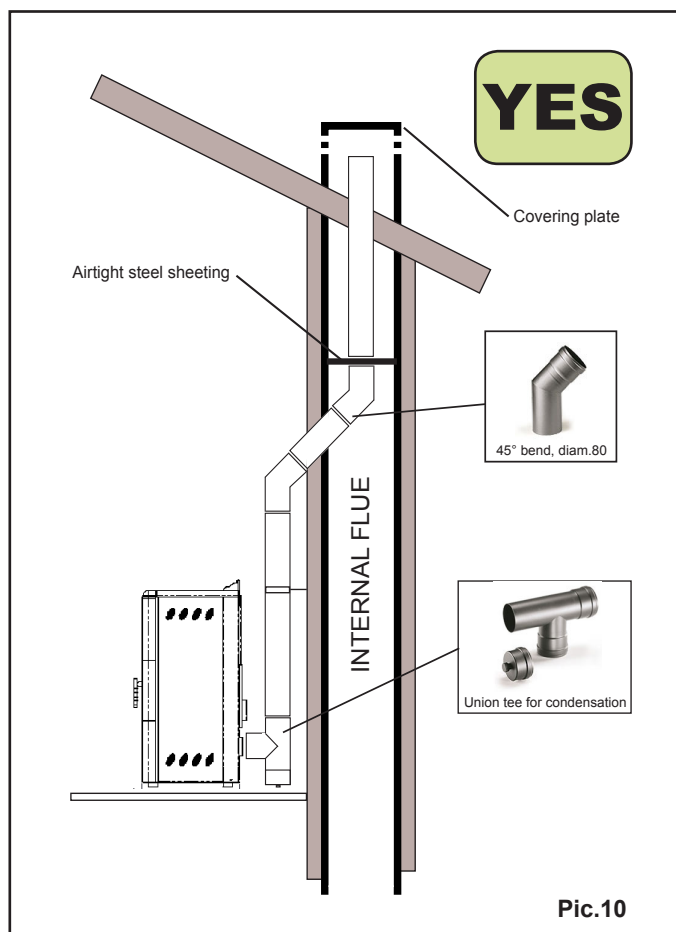

Pic.6

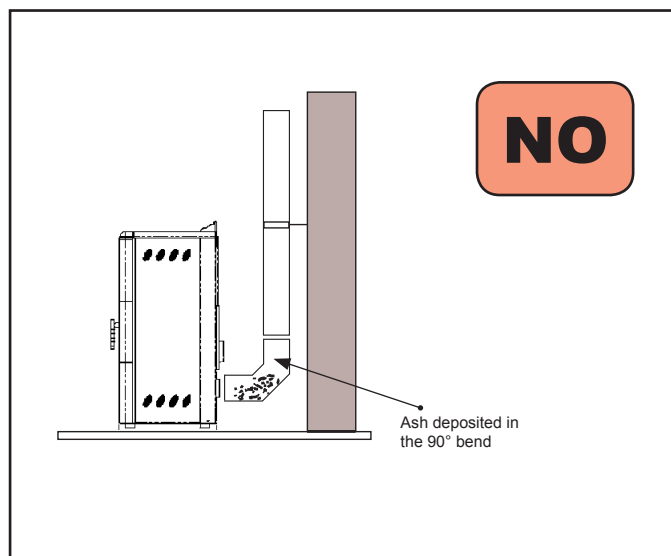

This type of installation (see Pic. 10) does not require an insulated flue as the smoke tube has been assembled partly inside the house and partly inside an existing flue.

In the lower part of the flue a union tee has been installed with a peephole cap.

A 90° bend should not be installed as the ash would quickly block the passage of smoke, causing problems for the draught of the flue (See Pic. 6).

Please note the use of 2 45° bends, to guarantee that the ash falls in the union tee with a peephole.

Pic.10

Determining Size of Pipe to install

To determine the diameter of pipe to use (3" or 4"), you can use the following guidelines.

Fillout the installation chart (table 1), and calculate your total equivalent pipe length.

Then use the total equivalent pipe length and the altitude in the pipe selection chart. (pic.11) to determine if your installation requires 3" or 4" exhaust pipe.

Table 1: Installation chart

Type of Pipe	# of Elbows or Feet of Pipe		Equivalent
90° Elbows/ Tee (A & G)		x	5 feet (1.5 m)
45° Elbows (C)		x	3 feet (1.0 m)
Horizontal (B & F)		x	1 feet (0.3 m)
Vertical (E)		x	0.5 feet (0.15 m)

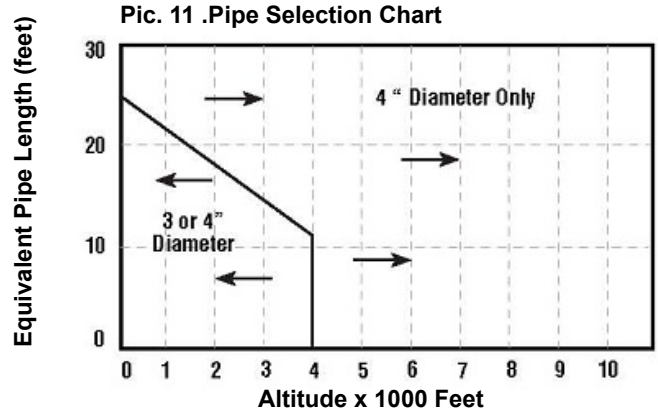

Sample installation chart

Type of Pipe	# of Elbows or Feet of Pipe		Equivalent	Total Equivalent
90° Elbows/ Tee (A & G)	2	x	5 feet (1.5 m)	10 feet (3.0 m)
45° Elbows (C)	1	x	3 feet (1.0 m)	3 feet (1.0 m)
Horizontal (B & F)	3	x	1 feet (0.3 m)	1 feet (1,0 m)
Vertical (E)	8	x	0.5 feet (0.15m)	1 feet (1,2 m)

Table 2 - Sample chart for pic.12

Equivalent pipe length = (10 + 3 + 1 + 1) ft = 15 ft

If the stove is installed in a place with an altitude of 2000 ft, it is possible to use either a pipe of 3" or of 4", as you can see in the pipe selection chart below.

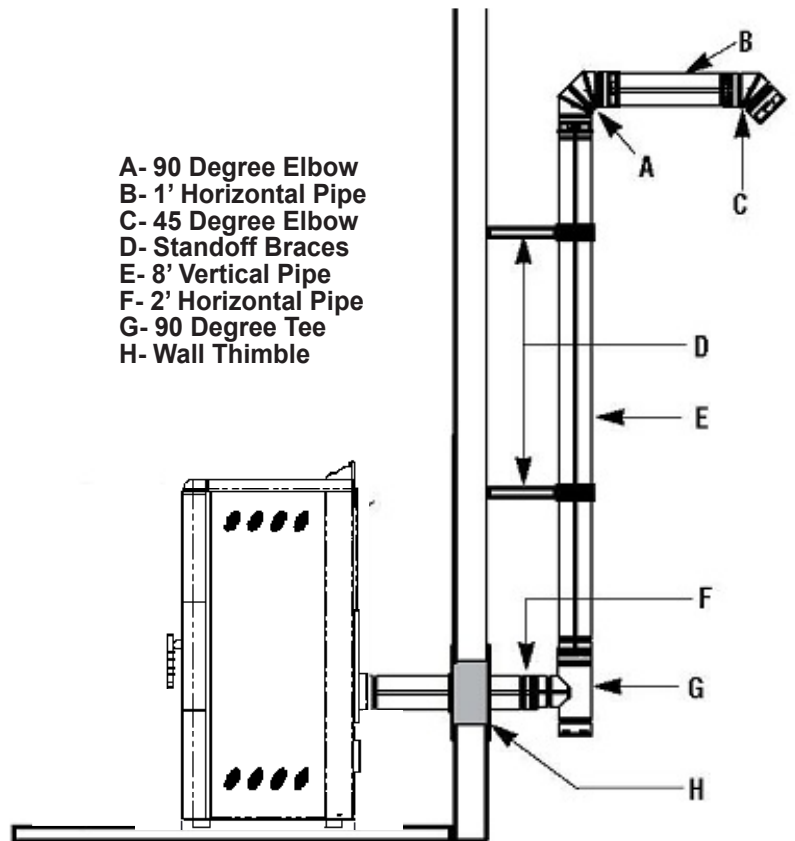
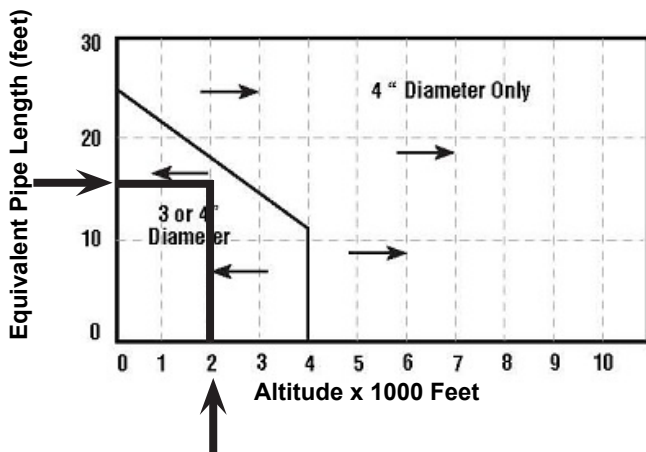

Pic. 12. See sample installation chart

Standard horizontal installation configurations

1. Locate the proper position for the listed type “PL” wall thimble. Avoid cutting wall studs when installing your pipe. Use a saber saw or keyhole saw to cut the proper diameter hole through the wall to accommodate the wall thimble. Use extreme caution to avoid cutting into power lines within the wall of the home. The hole size will depend on the brand of pellet vent that you are using. Install the wall thimble in the hole.

2. ALL INTERLOCKING PIPE CONNECTIONS WITH-IN THE ROOM MUST BE SEALED WITH HIGH TEMPERATURE RTV AND SECURED WITH A MINIMUM OF 3 FASTENERS PER CONNECTION. Position the stove approximately 12” (305 mm) from the wall on the floor pad. Push the “PL” pipe through the wall thimble. Squeeze a bead of high temperature silicone (RTV) sealer around the end of the machined portion of the 3” (76mm) pipe connector on the back of the stove. Firmly push on a section of “PL” pipe until inner pipe liner pushes into the bead of RTV sealer.

3. Push the stove with pipe attached towards the wall (the pipe will go through the wall thimble). Do not position the back of the stove closer than 2” (51mm) from the wall.

4. Install listed type “PL” 45 degree elbow with optional rodent screen or cap (recommended) on outside end of pipe. The rodent screen should be no less than 1/2” (13 mm) mesh and may clog with soot and ash if left unattended during the burn season.
NOTE: The end of the exhaust pipe must extend a minimum of 12” (305 mm) from the outside of the building.

5. If the installation includes a source of outside combustion air; cut a separate hole through the wall for the fresh air tube. Use a galvanized or stainless steel pipe for the duct. The minimum size for the duct shall be not less than 50% of the cross sectional flue area. Connect outside air pipe to air inlet on stove. This tube must be terminated with a 45 degree elbow or hood.

NOTES:
Combustion air may also be drawn from a vented crawl space under the home.
All joints for connector pipe are required to be fastened with at least three screws. If vented horizontally, joints shall be made gas-tight (air tight, sealed connection) in a manner as specified on this page (see instruction #2).
Install vent at clearances specified by the vent manufacturer.

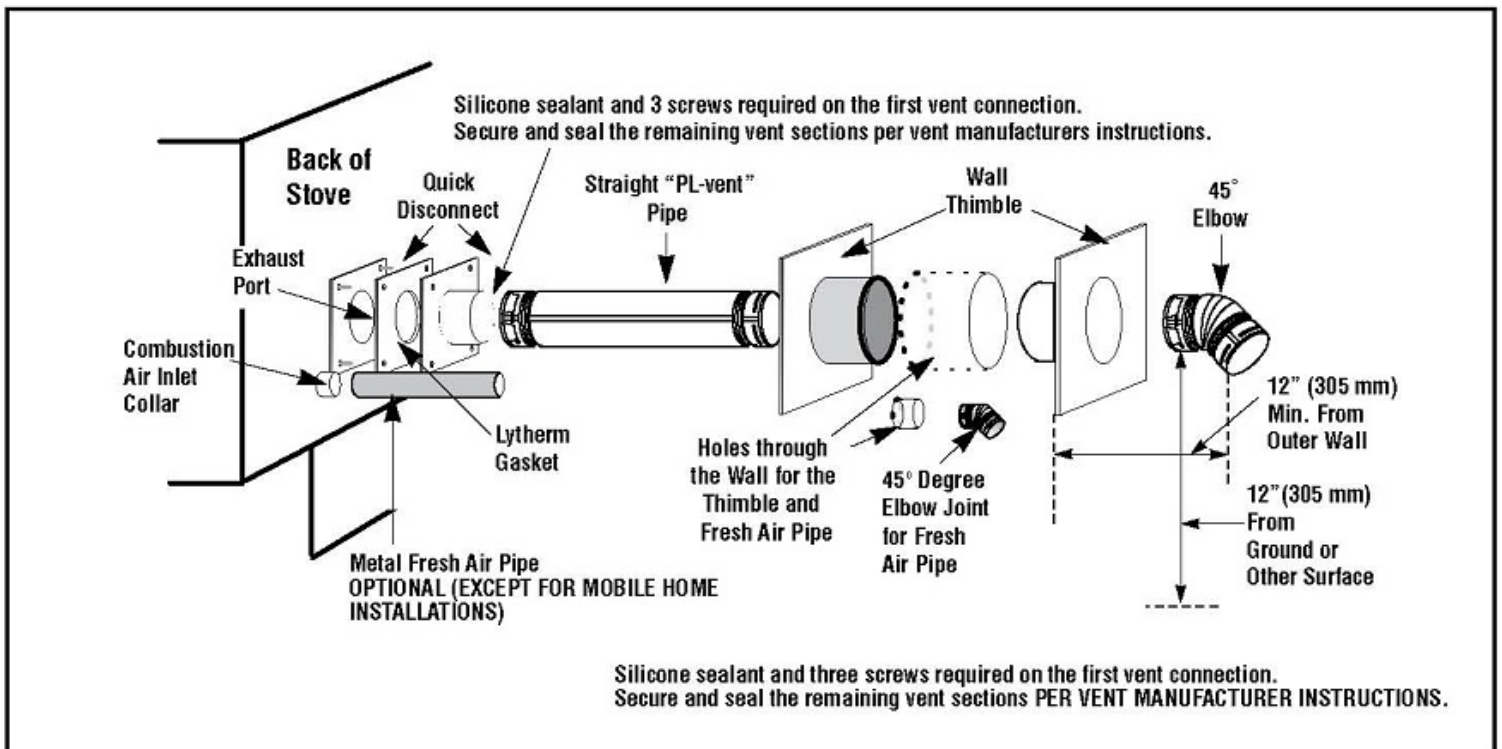

Pic. 13. Horizontal Vent installation

Standard horizontal installation configurations

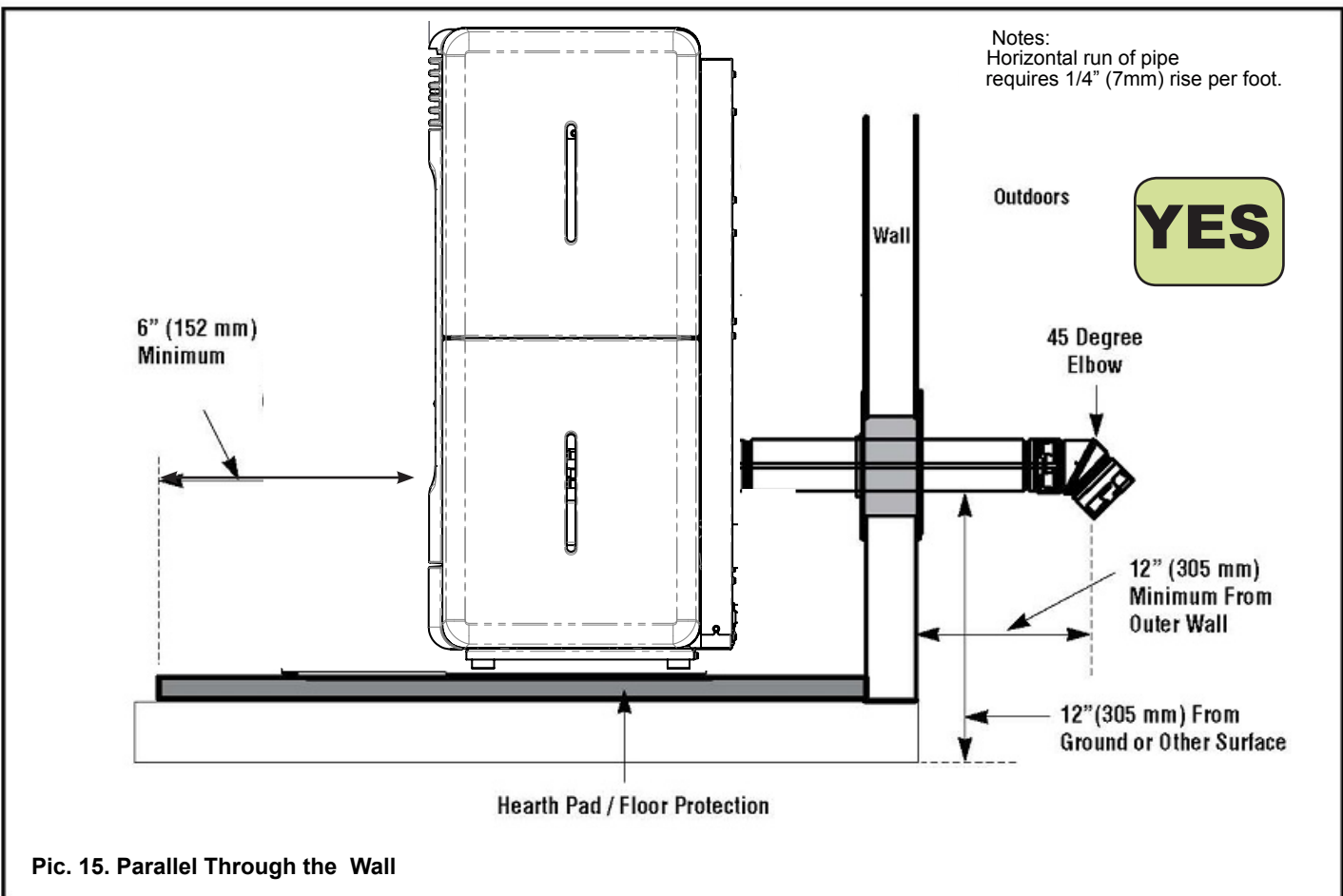
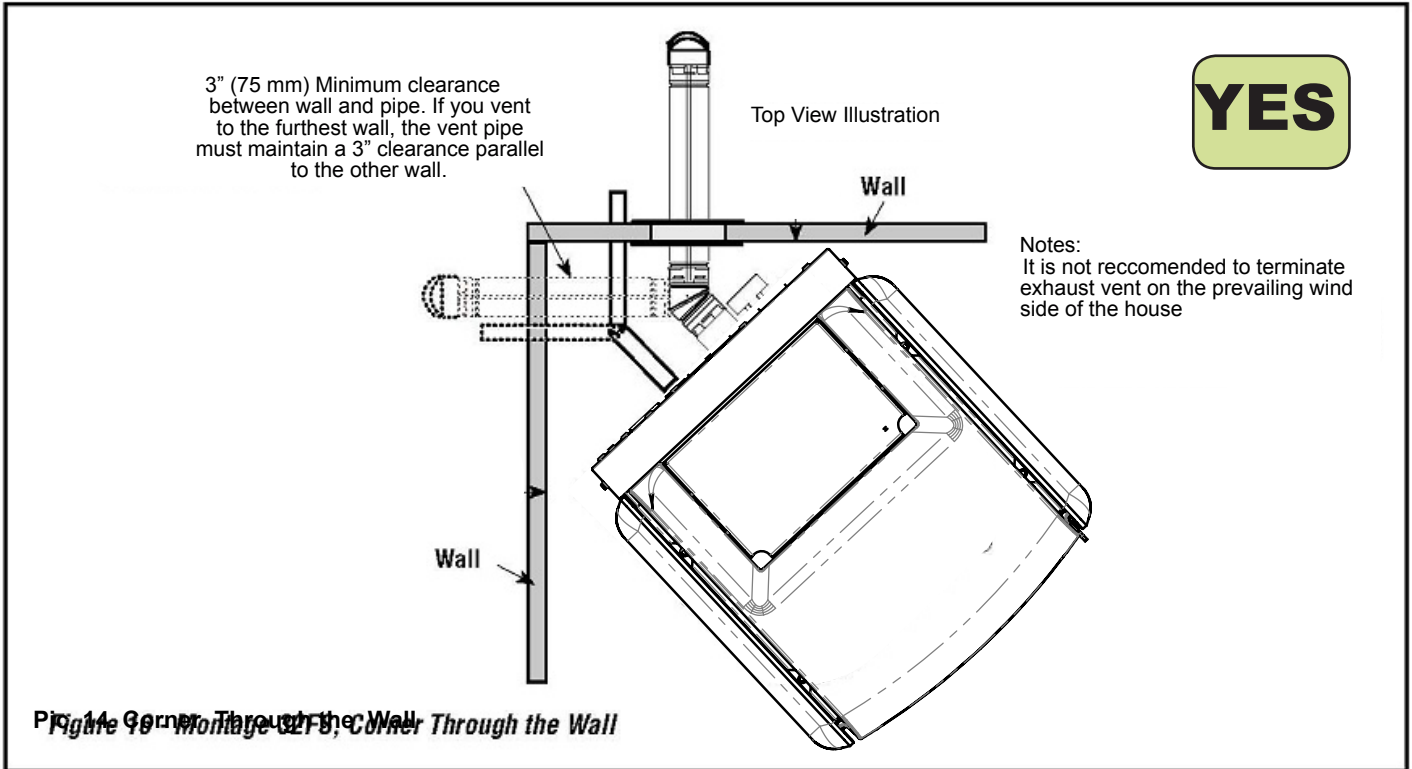

Preliminary Operations

Wiring



Connect the power cord to the back of the stove and then to a wall socket. The I/O switch in the figure should be set to I to power the stove. If voltage is not supplied check the state of the fuse installed in the box below the switch (4A fuse). During the periods of inactivity, we recommend you disconnect the power cord of the stove.

What to check before turning on the stove

Make sure you have removed all parts that pose the risk of burns from the combustion chamber or glass (various instructions or stickers).

Before turning on the stove, make sure you have fitted the grate on the support base and check that the door and the ash drawer are properly close.

How to load the pellets

Fuel supply consists in the insertion of pellets from the top of the stove, by opening the door. During pellet loading prevent the pellet bag from coming into contact with hot surfaces.



NEVER INSERT INTO THE TANK OTHER KIND OF FUEL OTHER FROM THE PELLETS
COMPLYING WITH THE SPECIFICATIONS BELOW

Description of the touch remote:

The touch remote is shown in the picture below:

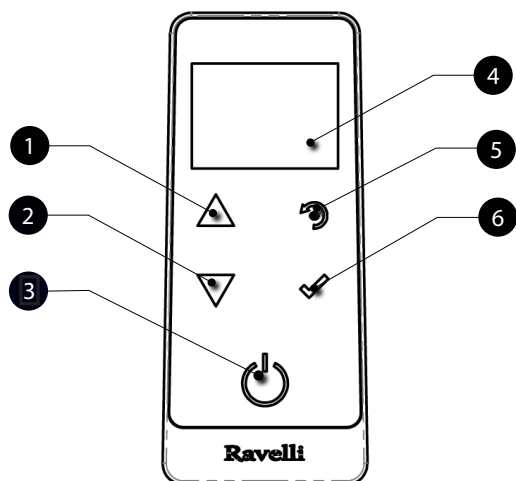

- 1 Increase button "UP" (selection key)
- 2 Decrease key "DOWN" (selection key)
- 3 ON/OFF or reset from "Sleep" mode key.
- 4 Display
- 5 Key for accessing the MENU and back
- 6 Confirmation key



In "Sleep" mode, the touch remote screen is obscured, keeping however active the radio communication with the stove to reduce battery consumption.

The information below will allow you to become familiar with the product and achieve the best performance.

How to insert the batteries in the touch remote:

Remove the protective cover of the battery on the back of the remote control as shown in Figure A, and insert the 3 batteries (mini pen style battery AAA 1.5V) in the housing of the touch remote and observe the poles. Install the battery protective cover as shown in figure B

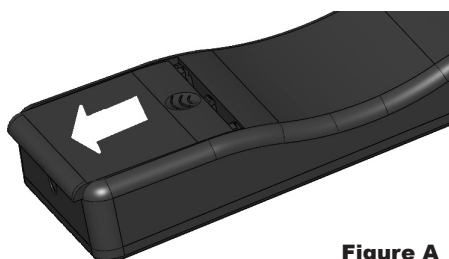

Figure A

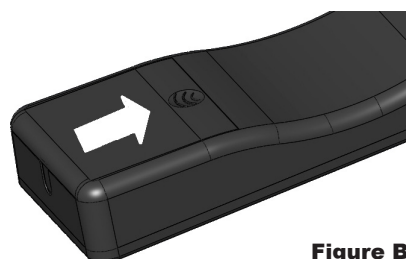

Figure B

The touch remote, after a short screen showing the Ravelli logo, will list the languages available in the menu.

ITALIANO
DEUTSCH
ENGLISH
FRANCAIS
DANSK
NEDERLANDS
ESPANIOL

Select the desired language using the scroll keys and confirm your selection with the confirmation button.

Touch remote radio initialization

In order to operate correctly, the touch remote should be interfaced with the electronic board installed inside the stove. For this reason, on display appears the following message:



If the touch remote is used for the first time, select **YES** using the selection keys and confirm with the dedicated key.

On the display of the touch remote appears the following:



Hold down for a few seconds the button of radio communication (RADIO ADJ) of the PCB, located on the back of the stove, to initialize the device.



The flashing yellow LED indicates that the circuit board is waiting to receive the signal from the touch remote.

By pressing the enter key on the touch remote, the components start communicating with each other. A check sign on the display, accompanied by a sound signal, shows that the initialization of the touch remote has been completed successfully.



i When you replace the batteries, you do not have to run the initialization procedure of the touch remote. In this case, when on display appears the message "FIRST INSTALLATION ?", select **NO** and press the confirmation key.

Description of the display

The display of the touch remote is described below (in stand-by)

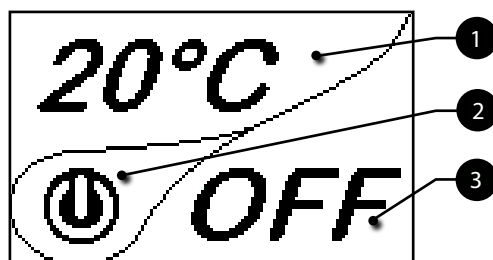

i After 5 minutes of inactivity, the display of the touch remote turns dark, switching to "SLEEP" mode, while maintaining the radio connection with the stove. By pressing the key ON/OFF, the display becomes active again.

i The first pressure of any key with the display active, lights up its backlight, but it is not, however, considered a command.

The display is subdivided into three parts:

- 1 It shows the current room temperature measured by the touch remote. Moreover, if you press the DOWN scroll key you will display the temperature settings that can be changed using the two UP/DOWN keys. Any change made is confirmed automatically within 3 seconds from the change or by pressing the confirmation key. A sound signal indicates that the change has been confirmed.



- 2 In the inactive phases (combined with the 3rd part of the display) indicates the state of the stove. In the active phases, it indicates the operating power of the stove. In addition, by pressing the DOWN scroll button, you can display the power settings, that can be edited using the two scroll keys
UP/DOWN: The confirmation of any change takes place automatically within 3 seconds from the change or by pressing the confirmation key. A sound signal indicates that the change has been confirmed.



3

Time and date setting

Below are given the steps for accessing the relative menu.

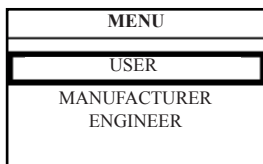

Press the key "access menu" to access the MENU page

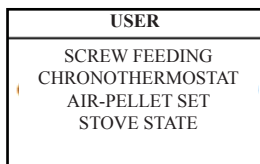

Press the key "confirm" to access the USER page

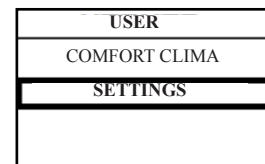

Press the key "selection" for "selection" to switch to the second page of USER MENU and select SETTINGS.



Press the key "confirm" to access the SETTINGS page

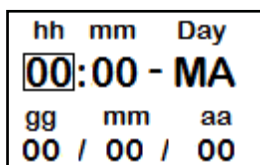

Press the key "confirm" to access the DATE-TIME page

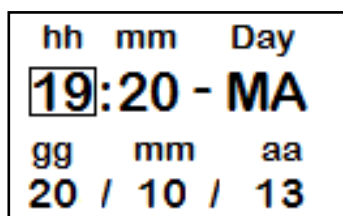

Press the increase key to change every single value



Press the decrease key to change every single value



Press "confirm" to confirm the settings and switch to the next value.



By pressing the key "back" for several times you will display the stand-by page.

8. Description of the functions

Loading the auger

 Carry out this operation to facilitate stove's first start operations; You should also check that you have introduced pellets into the hopper and wait until the stove is in "SHUTDOWN" or "FINAL CLEANING" mode. The number expressed in seconds indicates the rotation time of the infeed screw during the first loading cycle. Once this time has elapsed, the infeed screw stops immediately and then pellets are emptied from the grate before turning on the equipment.

Below are given the steps for accessing the relative menu.

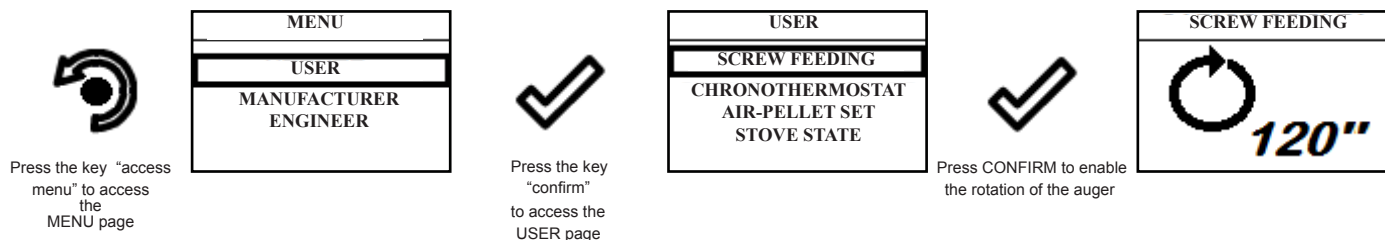

At the end of the auger loading, the display shows 0 "and automatically switches to the USER menu page.

 Press the key for several times until the Stand-by page is displayed.



ALWAYS EMPTY THE BRAZIER BEFORE TURNING THE STOVE ON AND ALWAYS CHECK THAT ALL NONE OF ITS HOLES IS CLOGGED NEVER EMPTY THE RBAZIER INSIDE THE HOPPER. FIRE HAZARD.

Setting operating temperature and power:

Set the two values following the indications given in the chapter "Description of thr display"

Turning the device on

Keep the key ON/OFF pressed for a few seconds to turn on the stove.

 The appearance of the message "ADJUST THE RDS SYSTEM" indicates that the initial parameter testing procedure and calibration has been unsuccessfully. This indication does not cause stove blockage (see the SIGNALLING POP UP section).

On the display of the touch remote appears the following:



Press and hold the ON/OFF button to turn off the stove door, and reset any alarms triggered.

 In case the infeed screw operations described avobe have not been executed, the stove may fail to turn on. In this case, carry out the operations described above and empty the brazier and reset the alarm.

If the stove still fails to turn on, check that the grate is properly installed and perfectly adherent to the base, and also check that there are no deposits that prevent the smooth passage of air to enable ignition. If the problem persists, contact the support service.

Sequence of ignition phases



SWITCH-ON- initial pellet loading phase;
WAIT FLAME - flame development wait phase;
FLAME PRESENT - flame stabilization phase and reduction of combustible inside the brazier;



WORK - operation phase described in the dedicated chapter;

What happens if the batteries are empty?



If the battery is discharged, within the "drop" is shown a symbol that indicates that the battery is empty, while maintaining active the features of your device.

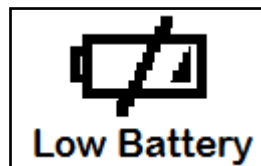

As soon as the level of the battery prevents the radio communication the touch remote displays on full screen the picture of empty battery and all device functions are locked until the batteries are replaced

Operating phases of the appliance

Modulation

During the work phase, the appliance should reach the room temperature set; when this condition is met, the stove switches to MODULATION mode in which fuel consumption and ventilation are minimum.

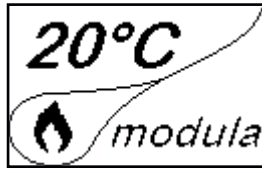

If you wish to detect the ambient temperature by means of an external thermostat (optional), this must be connected to the appropriate connector on the rear side of the stove; and you will have to activate the reading in "SETTINGS - EN - ABLE THERMOSTAT." On display appears the writing TON / TOFF based on thermostat request.



CONNECT AN EXTERNAL THERMOSTAT WITH A SIMPLE DRY CONTACT, THEREFORE, NOT POWERED. MOREOVER, WE RECOMMEND YOU USE A THERMOSTAT WITH A MINIMUM OFFSET OF 3°C IF YOU INTEND TO USE THE COMFORT CLIMA FUNCTION.

Comfort climate

The activation of this function enables the stove to reduce pellet consumption by activating the modulation phases, after the desired temperature has been reached. Subsequently, the stove checks that the temperature is maintained steady for a preset time. If this condition is met, it automatically switches off, and on display appears the writing ECO. The stove turns on again when the temperature drops below the set threshold.

Below are given the steps for accessing the relative menu.

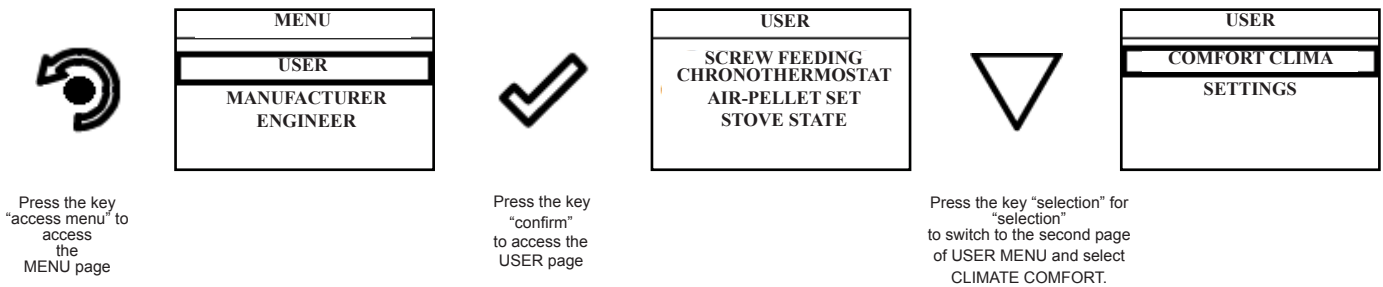

Once you have accessed the Climate Comfort menu, it is possible to operate on the 3 types of settings dedicated to the function:

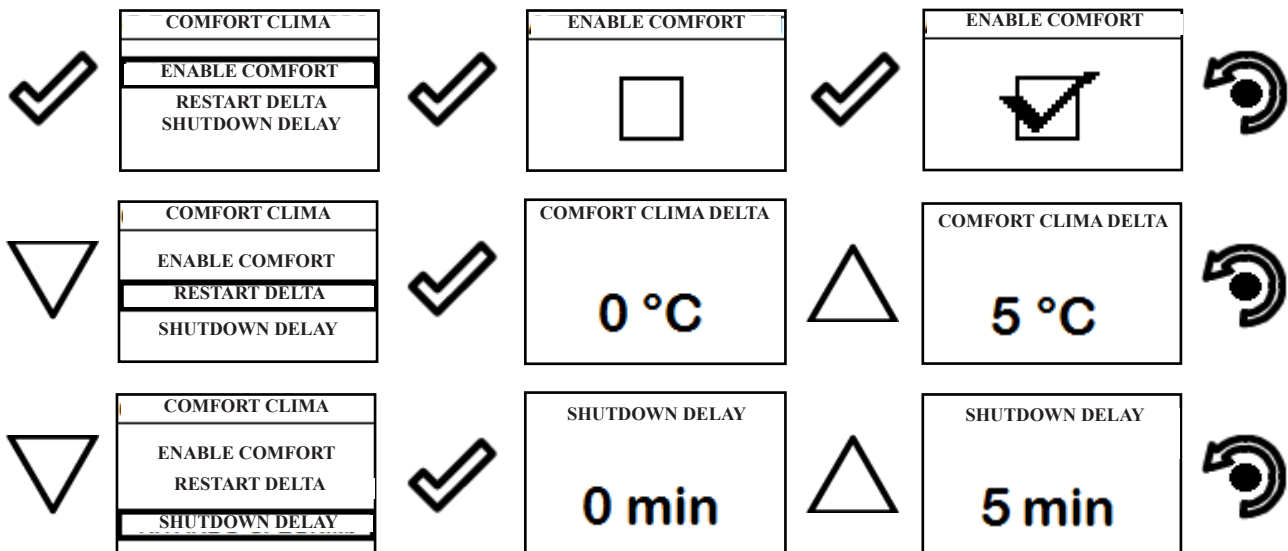

Press the key for several times until the Stand-by page is displayed.

The first setting allows the activation of the CLIMATE COMFORT function. This function is intended to ensure that the room temperature set is maintained steady upon setting the maximum period of "X" minutes (SWITCH-OFF DELAY: 5 MIN) before switching to ECO STOP phase. The STOVE maintains this state until the temperature drops below the set value (CLIMATE COMFORT DELTA : 5°C).

For example, with the room temperature at 21 ° C, the stove switches off when this temperature is reached and restarts when the temperature reaches 15°C (21°C - 5°C - 0,5°C tolerance).

You can also activate the function using an external thermostat, keeping in mind that this does not include the value of the hysteresis.



We recommend you use an external thermostat with a hysteresis value that can be set to maximum 3°C. The operation of the stove could activate the switch ON/OFF phases for several times during the day; this may affect the service life of the ignition coil.



USING THIS METHOD, IT IS NECESSARY TO VERIFY THAT AFTER EACH AUTOMATIC SHUTDOWN THE GRATE IS ALWAYS VERY CLEAN TO GUARANTEE CORRECT AUTOMATIC SWITCH ON.

Description of menu functions



Press the key to access the MENU page

MENU
USER
MANUFACTURER
ENGINEER



The TECHNICIAN and MANUFACTURER menus are protected by password.

Chronothermostat

With the Chrono-thermostat function you can program the automatic switch ON/OFF of the stove for each day of the week for each day of the week in 4 independent time intervals (SET CHRONO 1-2-3-4)

Below are given the steps for accessing the relative menu starting from Stand-By mode.



MENU
USER
MANUFACTURER
ENGINEER

Press the key "access menu" to access the MENU page



USER
SCREW FEEDING
CHRONOTHERMOSTAT
AIR-PELLET SET
STOVE STATE

Press the key "confirm" to access the USER page



USER
SCREW FEEDING
CHRONOTHERMOSTAT
AIR-PELLET SET
STOVE STATE

Press the key "selection" to quickly switch to CRONO-THERMOSTAT.



CHRONO
ENABLE CHRONO
SET CHRONO 1
SET CHRONO 2
SET CHRONO 3
SET CHRONO 4



ENABLE CHRONO
<input type="checkbox"/>



ENABLE CHRONO
<input checked="" type="checkbox"/>



CHRONO
ENABLE CHRONO
SET CHRONO 1
SET CHRONO 2
SET CHRONO 3
SET CHRONO 4



00,00	00,00
LU MA ME GI VE SA DO	
<input type="checkbox"/>	<input type="checkbox"/>
<input type="checkbox"/>	<input type="checkbox"/>
<input type="checkbox"/>	<input type="checkbox"/>
<input type="checkbox"/>	<input type="checkbox"/>
<input type="checkbox"/>	<input type="checkbox"/>
<input type="checkbox"/>	<input type="checkbox"/>
5	21

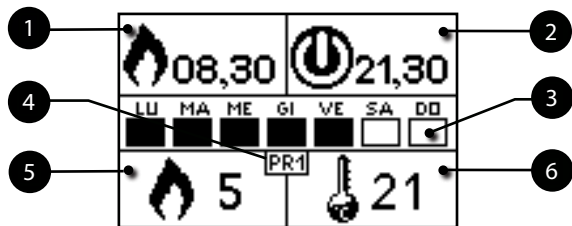

- 1 Settable switch-on program
- 2 Settable switch-off program
- 3 Day of the week with active program
- 4 Number of "chrono" program (1-2-3-4)
- 5 Setting the power upon programming
- 6 Setting ambient temperature



By pressing the Increment key you can change each value and, at step 3, enable the days of the week;



By pressing the Increment key you can change each value and, at step 3, enable the days of the week;



Press "confirm" to confirm the settings and switch to the next value;



Press the "back" button to return to the CHRONO-THERMOSTAT page.

As per the above example, it has been set as CHRONO 1 an ignition from 08.30 to 21.30 from MONDAY to FRIDAY at the operating power 5 with a room temperature set at 21 ° C. Programmes 2-3-4 can be set in the same manner.



To exit the CHRONO-THERMOSTAT function and return to Stand-by page, press the button repeatedly.

AIR / PELLETS setting

Setting of the PELLETT-FLOW mix enables you to immediately change the quantity of pellet loaded in the brazier and the air inflow. The stove is tested and inspected with DIN PLUS certified pellets. If using another type of pellets or uncertified pellets, fuel may need adjustment. Usually, the variation involves the FLOW percentage to adjust the input air and, therefore, the combustion; should the regulation of flow be insufficient, it may be necessary to also change the percentage of PELLETT load.

Below are given the steps for accessing the relative menu starting from Stand-By mode.

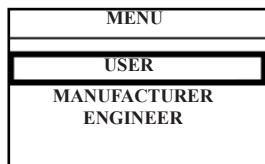

Press the key "access menu" to access the MENU page



Press the key "confirm" to access the USER page

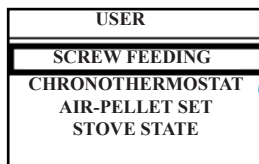

Press the key "selection" to quickly switch to SET AIR / PELLETS.

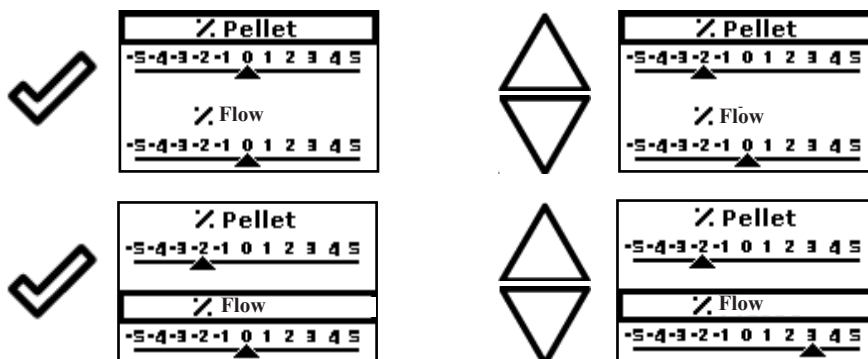
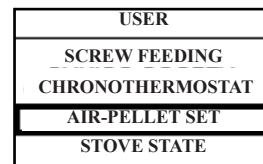

As per the above example, you have set a percentage of -2 for PELLETS and +3 for the FLOW, an indication that a setting like this is a consequence of the fact that the oxygen needed for combustion is insufficient and pellet size is smaller than the average size of 2 cm.



To exit the SET AIR - PELLETT function and return to Stand-by page, press the button repeatedly.



NOTE: The number indicated during the change of parameters refers only to a percentage value that acts on the default parameters set on the electronic board (exclusively in the WORK phase). These values should be changed in the event of poor combustion, due in many cases to the purchase of pellets differing from those used during stove testing.

Stove State

Below are given the steps for accessing the relative menu starting from Stand-By mode.



MENU
USER
MANUFACTURER ENGINEER



USER
SCREW FEEDING
CHRONOTHERMOSTAT
AIR-PELLET SET
STOVE STATE



USER
SCREW FEEDING
CHRONOTHERMOSTAT
AIR-PELLET SET
STOVE STATE

Press the key "access menu" to access the MENU page

Press the key "confirm" to access the USER page

Press the key "selection" to quickly switch to STOVE STATE.



RDS	00,00	m/s
RPM	0000	g/min
T	0030	°C
ALARM	ACTIVE	



SET	00,00	m/s
DF	0030	°C
DR	0030	°C
SK	0030	°C

In this mode you can check the proper operation of the most important parameters of the appliance. Below is a list of real data of the stove useful for service during inspection.

- Actual flow
- Fume extractor revolutions;
- Fume temperature;
- Stove state:
- Actual flow set;
- Inlet flow meter temperature;
- Heated flow meter temp.;
- Electronic board temperature;



To exit the STOVE STATE page and return to Stand-by page, press the button repeatedly.

Settings > Enable thermostat

Below are given the steps for accessing the relative menu starting from Stand-By mode.



MENU
USER
MANUFACTURER ENGINEER



USER
SCREW FEEDING
CHRONOTHERMOSTAT
AIR-PELLET SET
STOVE STATE



USER
COMFORT CLIMA
SETTINGS

Press the key "access menu" to access the MENU page

Press the key "confirm" to access the USER page

Press the key "selection" to quickly switch to the second page of the menu SETTINGS.



SETTINGS
DATE-TIME
ENABLE EXT. TH.
CONTRAST
FW VERSION
ADJUST
LANGUAGE



SETTINGS
DATE-TIME
ENABLE EXT. TH.
CONTRAST
FW VERSION
ADJUST
LANGUAGE



ENABLE THERMOSTAT
□

Press the key "confirm" to access the SETTINGS page

Press the key "selection" to switch to the function

Press the key "confirm" to access the function



ENABLE THERMOSTAT



In Stand-By mode, instead of the measured and settable ambient temperature appears the line T ON if the room where the thermostat is installed has not yet reached the requested value or the writing T OFF if the room temperature set has been reached.

Press the key "confirm" to enable the function.

ENABLE THERMOSTAT. By repeatedly pressing the key you will go back to the "STAND BY"

Settings

Below are given the steps for accessing the relative menu starting from Stand-By mode.

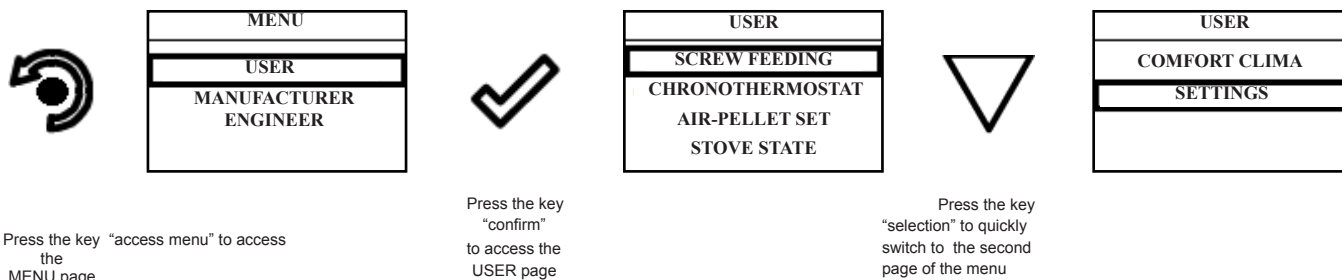

After following the procedure above step by step, you can set the following functions:

Settings > Contrast

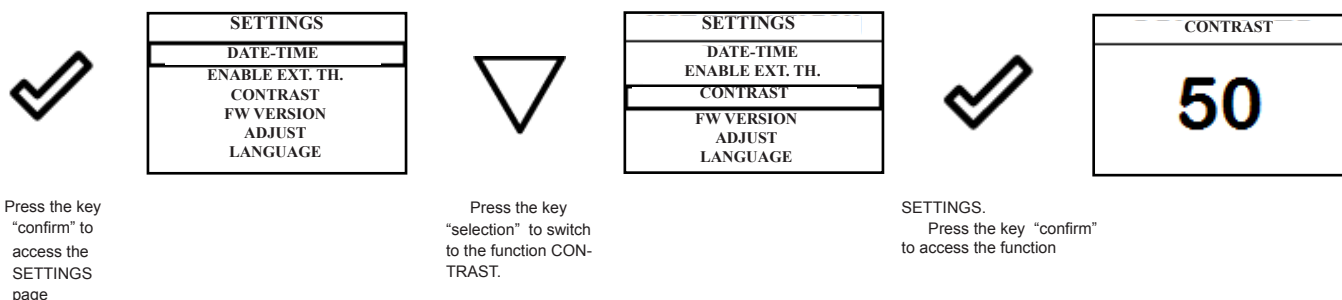

Use the UP/DOWN keys to change contrast setting and obtain a better visualisation of the information shown on the touch remote. The value can vary from 0 to 100. 50 with respect to

By pressing the following button you will confirm the data and switch to the page within the SETTINGS menu.

Settings > Firmware version

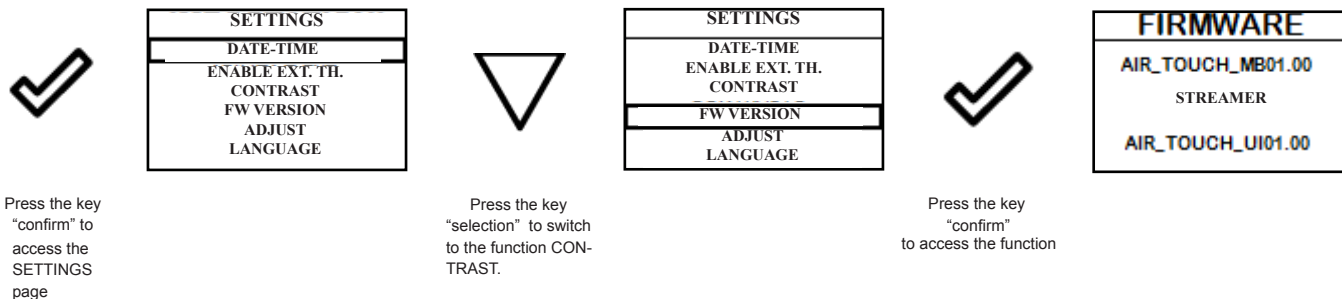

By pressing the following button you will confirm the data and switch to the page within the SETTINGS menu.

Settings > Adjust

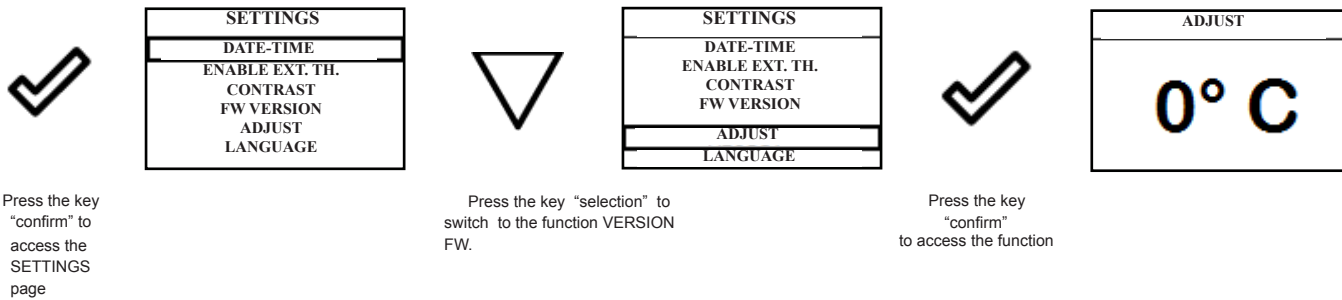

Use the UP/DOWN keys to change the value read by the room temperature probe installed inside the touch remote, with respect to a reference value. The value can vary from -10°C to 10°C. The standard value is 0°C.

By pressing the following button you will confirm the data and switch to the page within the SETTINGS menu.

Settings > Language

To access the next setting, follow the steps given above or simply remove and replace the batteries. The device resets and prompts you again to select the language you want to set.

Control

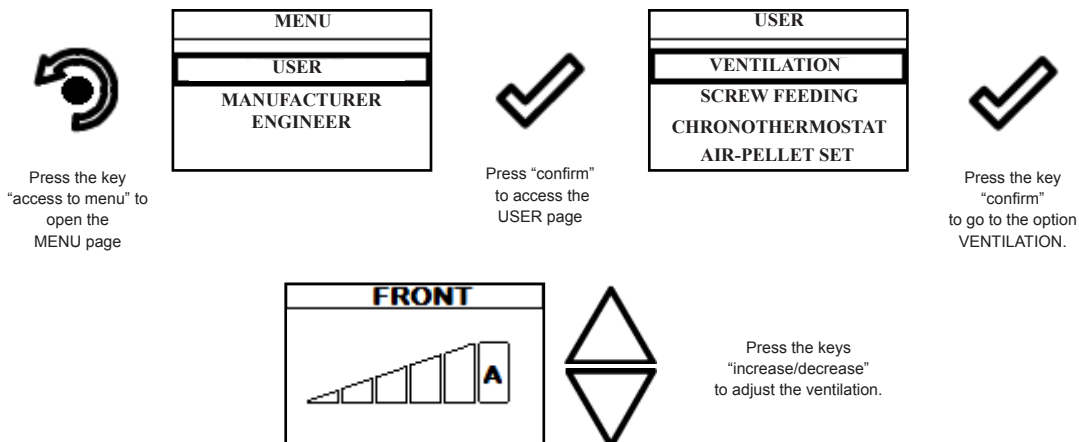

The exit key opens the VENTILATION menu again to set the other operating parameters available in the menu.

To exit the page and go back to Standby page, press the key for several times.

Control: the ventilation can be set from 0 to AUTO where 0 indicates that the same is disabled; settings from 1 to 5 enable the user to set the fan speed. If the value set is AUTO, the ventilation corresponds to the power set on the stove.

If the AUTO function is not enabled, the fan operation is not depending on stove's installed power, except for the cases in which the flame switches to modulation mode and the heat exchanger is forced to minimum.

Chrono function



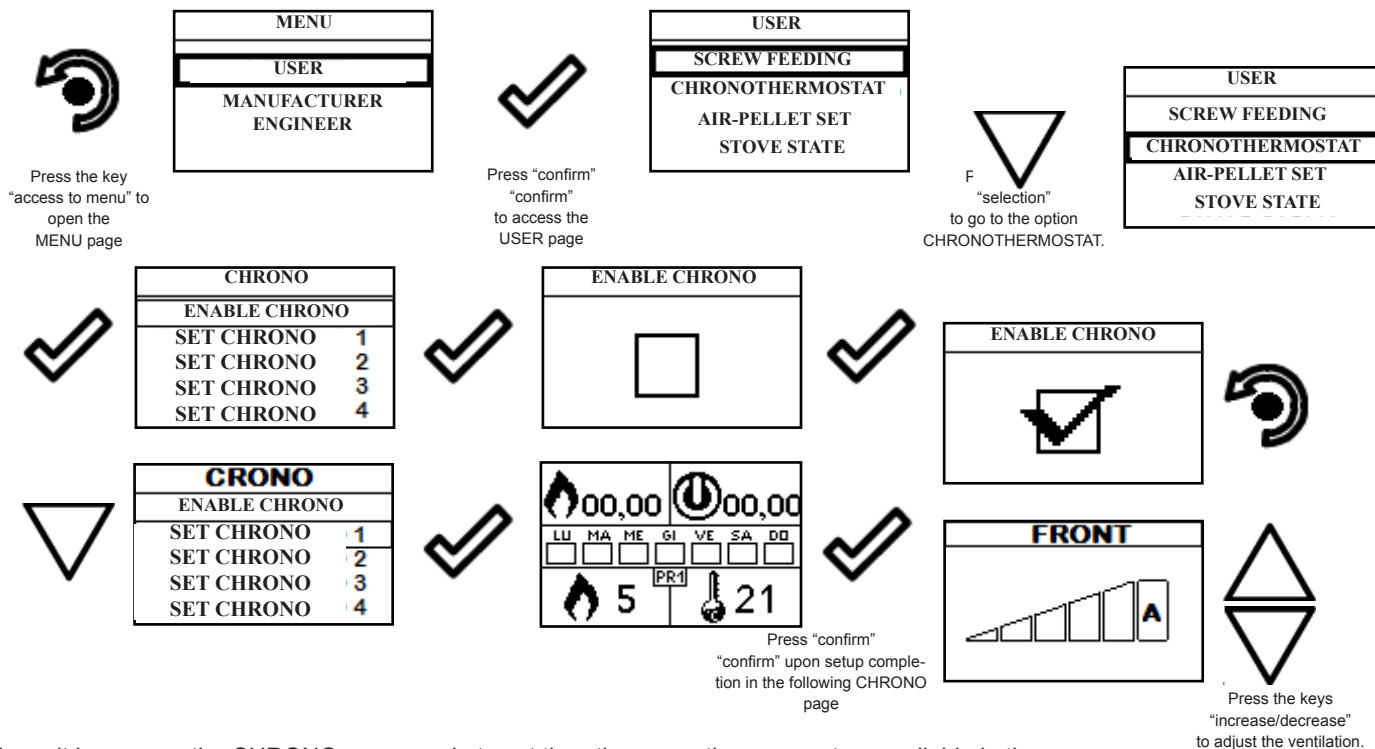



By activating the chrono function, the user can control the fan speed for each program, as shown in the logic above.



The exit key opens the CHRONO menu again to set the other operating parameters available in the menu.

To exit the page and go back to Standby page, press the key for several times.

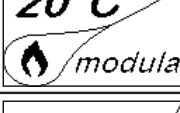
Stove phase synthetical layout

	PHASE	DESCRIPTION
	FINAL CLEANING	The stove is in the switch off phase and the cooling phase has not been completed yet.
	SWITCH ON	The heater pre-heating phase has started and the pellets start to fall into the grate.
	WAITING FOR FLAME	The pellets ignite and take advantage of the heat in the intake air that passes through the incandescent heater tube.
	FLAME PRESENT	The flame is visible in the grate.
	AREAS	The stove has completed the switch on phase and runs at maximum set capacity.
	WORK MODULA	The room temperature set has been reached.
	THE GRATE	Brazier cleaning phase is active (periodic function).
	ECO STOP	With Climate Comfort active, the stove switches to automatic switch-off mode when the room temperature set is reached (see the dedicated section).

	PHASE	DESCRIPTION
	START/RESTART WAIT	Switch-on is requested but with the stove in cooling phase; once this condition is met, it restarts automatically.
	SWITCH ON RESTART	The HOT restart phase is activated. Functioning is similar to the SWITCH ON phase
	HOT SMOKE	The maximum fume temperature threshold has been reached. To facilitate cooling, the stove brings the capacity to a minimum with ventilation at power level 5, leading to a decrease in fume temperature.
	OFF	The stove is off
	WAIT FOR PELLETS OUT OF	When the switch-on request from ECO-STOP mode coincides with an automatic switch-off condition (from the TIMER), the stove turns on ensuring total cleaning of the brazier before switching to FINAL CLEANING.
	INFEEED SCREW OVERFLOW	CONDITION: when the pellet setting (set pellets +5) is near the continuous load condition. SOLUTION: Set the value back to 0.
	GENERIC ALARM	The stove is in alarm state; refer to the troubleshooting chapter.
	ANOMALY (general)	The stove has detected an anomaly; refer to the troubleshooting chapter.
	AUTOMATIC CLEANING SYSTEM ACTIVE	For models with semiautomatic cleaning it indicates the state of the same.

Warning Pop-Up

	FLAME	DESCRIPTION
	RDS SYSTEM ADJUSTMENT REQUEST <i>(only if the RDS system is provided)</i>	It shows that the testing procedure and initial parameter calibration have not been completed or have been performed incorrectly. This indication, however, does not block the stove.
	SERVICE REQUEST	The threshold value of set work hours has been reached. The symbol displayed remains active throughout the work phase. Non-routine maintenance is required on the stove.
	AIR FLOW METER FAILURE <i>(only if the RDS system is provided)</i>	It shows a failure of the air flow meter and the stove switches to minimum capacity disabling the RDS system.

SIGNALLING	REASON	SOLUTION
 <i>(only if the RDS system is provided)</i>	• The door and the ash box are not closed correctly	• Make sure they are properly closed.
	• Poor combustion in grate.	• Switch off the stove, clean the brazier and check the cleanliness of the support bench, clean the tube bundle by activating the turbolators, and adjust the combustion through Pellet/Air settings.
	• Presence of foreign body in air intake tube.	• Check for any foreign body and remove it
	• The air flow meter may be dirty.	• Clean the flow meter with the stove in "Switched off" state
		• Contact the Support Service

The appearance of the message "ADJUST THE RDS SYSTEM" indicates that the initial parameter testing procedure and calibration has been unsuccessfully. This indication does not block the stove.

9. Description of Alarms (table with reference codes)

TRIAL	TITLE	REASON	SOLUTION
AL 01	BLACK OUT	- No voltage during work phase	- Press the switch off key and switch on boiler switch-on.
			- If the problem persists, contact the Support Service
AL 02	FUME PROBE	- The fume probe is malfunctioning	- Contact the Support Service
		- The fume probe is disconnected from the electronic board	- Contact the Support Service
AL 03	FUME OVERTEMP.	- Combustion in the brazier is not optimal due to clogging or obstructions of internal stove ducts	- Switch off the stove, clean the brazier and the tube bundle and adjust the combustion setting the Pellet/Air values
		- The tangential fan (if provided) is malfunctioning or damaged	- Contact the Support Service
			- If the problem persists, contact the Support Service
AL 04	FUME EXHAUST DAMAGED	- Fume exhaust encoder is not working or is connected incorrectly	- Contact the Support Service
		- No power to fume exhaust system	- Contact the Support Service
		- The fume exhaust system is blocked	- Contact the Support Service
AL 05	NO SWITCH-ON	- The pellet tank is empty	- Check for the presence of pellets in the container. Top up, if necessary.
		- Pellet calibration and suction during switch on phase is incorrect.	- Contact the Support Service
		- The ignition coil is faulty or positioned	- Contact the Support Service
AL 06	PELLETS FINISHED	- The pellet tank is empty.	- Check for the presence of pellets in the container. Top up, if necessary.
		- The gear motor is not loading pellets	- Empty the tank to see if there are any objects inside that may prevent the proper operation of the auger.
		- Not enough pellets loaded	- Regulate pellets setting from "SET AIR/PELLETS"
			- If the problem persists, contact the Support Service Support
AL 07	RESET THERMAL BREAKER / PELLET DOOR OR GATE OPEN	- The manual reset thermostat has tripped connected to the hopper (RESET THERMAL BREAKER / Pellet door or gate is open)	- Reset the thermostat by pressing the button on the back of the stove or close the doors.
		- Combustion in the grate is not optimal due to the fact that the grate is clogged or the inner stove ducts are clogged. (RESET THERMAL BREAKER)	- Switch off the stove, clean the brazier and the tube bundle and adjust the combustion setting the Pellet/Air values
			- Contact the Support Service
AL 08	DEPRESSURIZATION	- The flue is blocked.	Check the flue is free and clean
		- The vacuum meter is faulty.	- Contact the Support Service
AL 12	FUME EXHAUST SYSTEM FAILURE	- The fume exhaust system has a loss of performance due to fan obstruction or voltage drop.	- Contact the Support Service
AL 14	SCREW PHASE	- No cable connection to power the gear motor of the auger	- Contact the Support Service
AL 15	AUGER TRIAC	- An internal part of the electronic board that controls the pellet infeed screw is faulty.	- Contact the Support Service
		- Possible voltage drops or incorrect input voltage stove inlet	- Check the mains voltage.
AL 17	NO FLOW <i>(only if the RDS system is provided)</i>	- The flow meter does not measure inlet air flow	- Check if the ash pan and door are closed correctly and check if the air inlet pipe is obstructed.
			- If the problem persists, contact the Support Service
AL 19	CLEANER FAILURE <i>(for models equipped with cleaner)</i>	- The cleaner did not complete the movement and is not in the correct position	- Reset the alarm and wait for the stove to switch to SHUTDOWN mode. Cut off and power again, the system reactivates the cleaner trying to search the correct position again.
			-- If the problem persists, contact the Support Service



In the case of alarm 07 THERMAL BREAKER below shows the location where to operate to reset the thermal switch with manual reset.

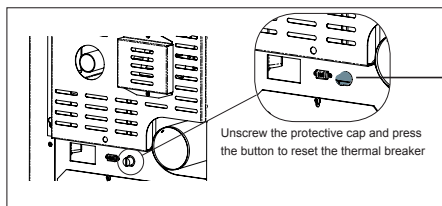

Manual reset thermal breaker



Unscrew the protective cap and press the button to reset the thermal breaker



Pellet door/gate open



Cleaning should be provided by the user

Before any cleaning operation on the stove, implement the following precautions:

- switch off the stove and disconnect the power cord with the stove in "Switched OFF" state;
- make sure all the parts of the stove are cold;
- make sure the ash is completely cooled.



PLEASE READ CAREFULLY THE FOLLOWING INSTRUCTIONS TO PERFORM PROPER CLEANING.
FAILURE TO COMPLY WITH THESE INSTRUCTIONS MAY LEAD TO MALFUNCTIONS OF THE STOVE.

10. The electrical wiring diagram

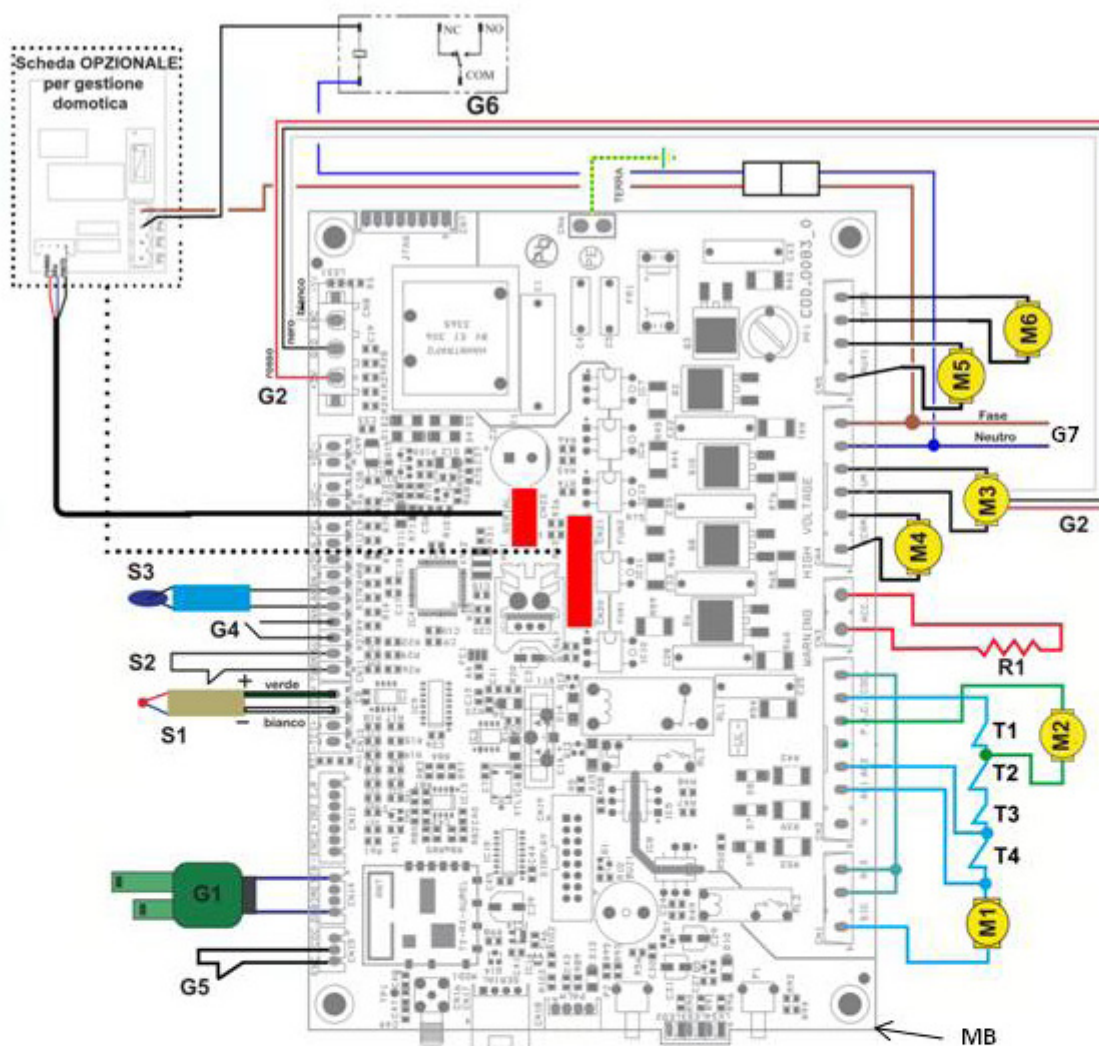

- | | |
|--------------------------------|-----------------------------------|
| MB – Mother board | R1 – Ignition resistance |
| T1 – Door safety switch | G4 – Burnpot cleaner switch |
| T2 – Pellet lid safety switch | G7 – Power cord plug; main switch |
| T3 – Safety temperature switch | |
| T4 – Safety pressure switch | |
| M1 – Auger motor | |
| M2 – Burnpot cleaner motor | |
| M3 – Flue fan | |
| M4 – Front ambient fan | |
| M5 – Rear right ambient fan * | |
| M6 – Rear left ambient fan * | |

* Only for ducted stoves

11. Maintenance



Cleaning should be provided by the user

Before any cleaning operation on the stove, implement the following precautions:

- switch off the stove and disconnect the power cord with the stove in "Switched OFF" state;
- make sure all the parts of the stove are cold;
- make sure the ash is completely cooled.



PLEASE READ CAREFULLY THE FOLLOWING INSTRUCTIONS TO PERFORM PROPER CLEANING. FAILURE TO COMPLY WITH THESE INSTRUCTIONS MAY LEAD TO MALFUNCTIONS OF THE STOVE.

Before carrying out any maintenance operation on the stove, please take the following precautions:

- Make sure that all the parts of the stove are cold
- Make sure that the ashes are completely extinguished
- Make sure that the general switch is in the zero position (off)
- Make sure that the plug is disconnected from the socket, thus avoiding accidental contacts.

IMPORTANT

Please follow the instructions for cleaning shown below carefully! Failure to observe them may lead to problems in the functioning of the stove AND FIRE HAZZARD.

11.1. Cleaning the surfaces

To clean the surfaces on the painted metal parts, use a wet cloth in water or at the most, water and soap.

Important: the use of aggressive detergents or diluents can damage the surfaces of the stove.

11.2. Cleaning the FIREX 600



All Ravelli products have a combustion chamber made with FIREX 600, a material based on vermiculite, the result of research and development by Ravelli. The main features of FIREX 600 are resistant to heat, its lightness and excellent insulating capacities, improving the combustion and performance of the stove.

During combustion, FIREX 600 turns white, due to an effect called PYROLYSIS, making the flame clear and shining. If the combustion is regulated in an optimal way, the FIREX 600 interior always remains clean and white.

The condition of FIREX 600 is therefore a thermometer to understand whether the combustion is good or not.

FIREX 600 LIGHT – GOOD COMBUSTION

FIREX 600 DARK – POOR COMBUSTION

Firex 600 does not require special maintenance, it only has to be dusted with a soft brush to remove the ash that is deposited during combustion.

Abrasive sponges to clean to most resistant waste should not be used as they could compromise the thickness of the FIREX600 panel, creating critical points of breakage.

The tube of the vacuum cleaner should not be used in direct contact with FIREX 600.

Wet cloths should not be used to clean FIREX 600.

FIREX 600 is resistant to heat but not to knocks; handle with care if moved.

FIREX 600 may show a slight abrasion after a few hours of functioning, this is perfectly normal as the flame creates microgrooves in the panel without compromising it.

The duration of FIREX 600 depends only on how maintenance is carried out.

The pellet stove is a generator of heat with a solid fuel and as such requires servicing by qualified personnel at least once a year at the start of the season. This maintenance has the purpose of ascertaining and ensuring the perfect efficiency of all the components.

We recommend you draw up an annual contract for maintenance of the product with your installer/dealer.

12. Guarantee

12.1. Certificate of Guarantee

Ravelli thanks you for the confidence you have placed in it with the purchase of one of our pellet stoves and invites the purchaser to:

- examine the instructions for the installation, use and maintenance of the stove.
- examine the conditions of guarantee shown below.

The enclosed coupon must be filled in and stamped by the installer. If this does not occur, the product will not be covered by the guarantee.

12.2. Conditions of guarantee

The limited guarantee covers defects of manufacturing materials, on condition that the product has not been broken due to an incorrect use, carelessness, wrong connections or errors of installation.

The following are not covered by guarantee:

- vermiculite (Firex 600);
- the glass of the door;
- the fibre gaskets;
- the painting;
- the fire pot;
- ignitor;
- the cast majolica;
- any damage caused by inappropriate installation and/or handling of the stove and/or shortcomings by the consumer.

The use of poor quality pellets or of any other material could damage components of the stove causing the termination of their guarantee and the annexed responsibility of the manufacturer.

The guarantee is void if the stove is not operated according to the owner's manual.

The pellets which meet the requisites listed in the chapter on them should be used.

All damage caused by transport are not acknowledged, therefore please carefully check the goods on receipt, immediately advising the dealer of any damage.

All the manufacturer's guarantees are shown here and no complaint may be made to the manufacturer according to any other guarantee, report or request.

For guarantee claims and instructions for return shipments please refer to your local dealer.

The guarantee coupon must be detached and sent to the following address within eight days of purchase:

**Ravelli c/o Aico Spa
Via Kupfer 31
25036
Palazzolo s/O Brescia ITALY**

12.3. Information and problems

For any information or problems, please contact your dealer or service centre, the only people who can meet any request you may have end, if necessary, who can intervene directly.

Ravelli[®]

il fuoco intelligente

AICO SPA

Via Kupfer, 31 - 25036 Palazzolo sull'Oglio / BS - ITALY

Tel. +39.030.7402939

Fax. +39.030.7301758

Internet : www.ravelligroup.it

E-mail : info@ravelligroup.it

Ravelli does not assume any responsibility for any errors in this booklet and considers itself free to make any variations to the features of its products without notice.