

Owner's Manual

Care and Operation

Pour demander un exemplaire en français de ce Manuel du propriétaire, visitez www.fireplaces.com/translations

INSTALLER: Leave this manual with party responsible for use and operation.

OWNER: Retain this manual for future reference.

NOTICE: DO NOT discard this manual!

HEARTH & HOME
technologies

Model(s):
Pioneer-III-ABK
Pioneer-III-RBK

UL
LISTED

EPA

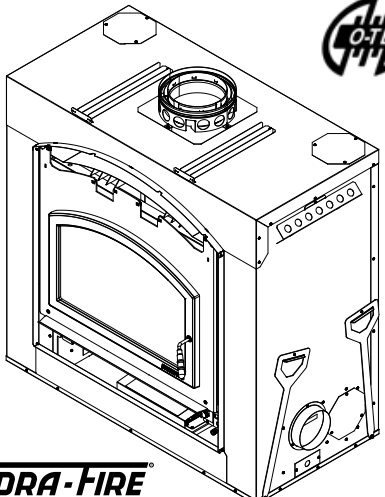

QUADRA-FIRE
EPA CERTIFIED WOODBURNING
FIREPLACE

Installation and service of this appliance should be performed by qualified personnel. Hearth & Home Technologies recommends HHT Factory Trained or NFI certified professionals.



⚠ WARNING: If the information in these instructions is not followed exactly, a fire or explosion may result causing property damage, personal injury, or death.

- **DO NOT** store or use gasoline or other flammable vapors and liquids in the vicinity of this or any other appliance.
- **DO NOT** overfire. Overfiring will void your warranty.
- Comply with all minimum clearances to combustibles as specified. Failure to comply may cause house fire.

⚠ WARNING



HOT SURFACES!

Glass and other surfaces are hot during operation AND cool down.

Hot glass will cause burns.

- **DO NOT** touch glass until it is cooled
 - **NEVER** allow children to touch glass
 - Keep children away
 - **CAREFULLY SUPERVISE** children in same room as fireplace.
 - Alert children and adults to hazards of high temperatures.
- High temperatures may ignite clothing or other flammable materials.**
- Keep clothing, furniture, draperies and other flammable materials away.

⚠ WARNING



Fire Risk.

For use with solid wood fuel only.
Other fuels may overfire and generate poisonous gases (i.e. carbon monoxide).

Safety Alert Key:

- **DANGER!** Indicates a hazardous situation which, if not avoided will result in death or serious injury.
- **WARNING!** Indicates a hazardous situation which, if not avoided could result in death or serious injury.
- **CAUTION!** Indicates a hazardous situation which, if not avoided, could result in minor or moderate injury.
- **NOTICE:** Indicates practices which may cause damage to the fireplace or to property.

Table of Contents

1 Welcome		4 Maintenance and Service	
A. Congratulations	3	A. Maintenance Tasks-Homeowners	21
B. LIMITED LIFETIME WARRANTY	4	1. Chimney Inspection	21
2 Product Specific Information		2. Creosote (Chimney) Cleaning	22
A. Fireplace Certification	6	3. Care and Cleaning of Plated Surfaces	23
▶ B. BTU & Efficiency Specifications	6	4. Glass Door	23
C. Mobile Home Approved	6	5. Glass Cleaning	23
D. Glass Specifications	6	6. Door Gasket	23
3 Important Safety and Operating Information		7. Ash Removal	23
A. Fireplace Safety	7	8. Baffle and Blanket	23
1. Clear Space	7	9. Firebrick	23
2. Firebrick	8	B. Replacement Maintenance	24
3. Baffle and Blanket	8	1. Glass Replacement	24
4. Over-Firing Your Fireplace	8	2. Tighten or Adjust Door Latch	24
5. Chimney Fire	8	3. Manifold Tubes Removal and Replacement	24
B. General Operating Parts	9	4. Door Handle Assembly	24
1. Smart Burn Technology System Activation	10	5. Firebrick Replacement	24
2. Thermostat Location & Wiring to Fireplace	11	6. Thermocouple Replacement	26
3. Thermostat Control	11	7. Baffle Removal and Installation	27
4. Outside Air	12	8. Fan Replacement	27
5. Glass Doors	12	5 Troubleshooting	
6. Convection Fan Operation	12	A. FAQs	29
7. Battery Holder	12	B. Troubleshooting Table	31
C. Fuel	13	6 Reference Materials	
1. Hardwood vs. Softwood	14	A. Service Parts	34
2. Moisture Content	14	B. Contact Information	39
3. Seasoning	14		
4. Storing Wood	15		
5. Burning Process	15		
6. Dirty Glass	15		
7. Creosote Formation	15		
8. Opacity	15		
D. First Fire	15		
E. Lighting Instructions	16		
F. Heat Output Control	18		
G. Manual Override of Air Control	18		
H. Frequently Asked Questions	19		
I. Quick Start Guide	20		

1 Welcome

Read this manual before installing or operating this fireplace.
Please retain this owner's manual for future references.

A. Congratulations

Congratulations on selecting a Quadra-Fire wood burning fireplace. The Quadra-Fire fireplace you have selected is designed to provide the utmost in safety, reliability, and efficiency.

As the owner of a new fireplace, you'll want to read and carefully follow all of the instructions contained in this Owner's Manual. Pay special attention to all Cautions and Warnings.

This Owner's Manual should be retained for future reference. We suggest that you keep it with your other important documents and product manuals.

Your new Quadra-Fire wood burning fireplace will give you years of durable use and trouble-free enjoyment. Welcome to the Quadra-Fire family of fireplace products!

Quadra-fire is a registered trademark of Hearth & Home Technologies.

Local Dealer Information

DEALER: Fill in your name, address, phone and email information here and fireplace information below.

Dealer Name: _____
 Address: _____

 Phone: _____
 Email: _____

Fireplace Information:

Brand: _____ Model Name: _____
 Serial Number: _____ Date Installed: _____

Listing Label Information/Location

The model information regarding your specific fireplace can be found on the rating plate usually located in the control area of the fireplace.

Model: Pioneer-III
EPA CERTIFIED FIREPLACE

QUADRA-FIRE
 NOTHING BURNS LIKE A QUAD

SERIAL NO./NUMERO DESERE: MP182
MODEL/MODELE: PIONEER-III

Model Number (points to PIONEER-III)
Serial Number (points to MP182)

CHIMNEY/CHEMNEE CLEARANCE TO COMBUSTIBLES:

BACK	1	IN. MIN.
RETOUR	25	MM MIN.
SIDE	1-1/2	IN. MIN.
COTE	38	MM MIN.

4182-990A

B. LIMITED LIFETIME WARRANTY

Hearth & Home Technologies LLC LIMITED WARRANTY

Hearth & Home Technologies LLC (“HHT”) extends the following warranty for HHT gas, wood, pellet and electric hearth appliances (each a “Product” and collectively, the “Product(s)”) and certain component parts set forth in the table below (“Component Part(s)”) that are purchased from a HHT authorized dealer or distributor.

WARRANTY COVERAGE:

HHT warrants that the Products and their Component Parts will be free from defects in materials and workmanship for the applicable period of Warranty coverage set forth in the table below (“Warranty Period”). If a Product or Component Parts are found to be defective in materials or workmanship during the applicable Warranty Period, HHT will, at our discretion, repair the applicable Component Part(s), replace the applicable Component Part(s), or refund the purchase price of the applicable Product(s). The maximum amount recoverable under this Warranty is limited to the purchase price of the Product. This Warranty is transferable from the original purchaser to subsequent owners, but the Warranty Period will not be extended in duration or expanded in coverage for any such transfer. This Warranty is subject to conditions, exclusions, and limitations as described below.

WARRANTY PERIOD:

Warranty coverage begins at the date of installation. In the case of new home constructions, Warranty coverage begins six months after invoice of the final sale of the Product(s) by an independent, authorized HHT dealer or distributor. However, the Warranty coverage shall commence no later than 24 months following the date of Product shipment from HHT, regardless of the installation or purchase date.

Warranty Period		HHT Manufactured Appliances and Venting					
Component Parts	Labor	Gas	Pellet	Wood	Electric	Component Parts Covered by this Warranty	
1 Year		X	X	X		All parts including handles, external enameled components and other material except as covered by Warranty Conditions, Warranty Exclusions, and Warranty Limitations listed	
2 Years					X	All parts except as covered by Warranty Conditions, Warranty Exclusions, and Warranty Limitations listed	
			X	X		Glass, Electrical components limited to heating element/igniters, Top feed auger assembly, Blowers, Junction Box, Remotes/Wall switches, linear actuator, power cord, vacuum switch, snap disc, wire harnesses and thermocouple	
		X				Electrical components limited to modules, remotes/wall switches, valves, pilots, blowers, junction boxes, wire harnesses, transformers and lights (excluding light bulbs)	
		X		X		Cement Refractory Panels, Glass Liner Panels	
3 years			X			Firepots, burnpots, Harman mechanical feeders	
5 years		X		X		Catalysts, Vented and Vent Free burners and logs	
10 years	1 year	X				Burners, logs and metal/fiber refractory components of HHT manufactured fireplaces or stoves, venting due to poor workmanship	
10 years	3 years		X	X		Castings, Medallions & Baffles, FlexBurn® System (engine, inner cover, access cover and fireback), Firebox and heat exchanger, HHT Chimney & Terminations, Manifolds	
20 years	3 years	X				Firebox and heat exchanger	
All purchased replacement parts and optional accessories							
1 Year	None	X	X	X	X	All purchased replacement parts and optional accessories	

WARRANTY CONDITIONS:

- Because HHT cannot control the quality of any Products sold by unauthorized sellers, this Warranty only covers Products that are purchased through an HHT authorized dealer or distributor unless otherwise prohibited by law; a list of HHT authorized dealers is available on the HHT branded websites.
- This Warranty is only valid while the applicable Product remains at the site of original installation.
- This Warranty is only valid in the country in which the HHT authorized dealer or distributor that sold the applicable Product is authorized to sell applicable Product.
- Contact your installing distributor or dealer for Warranty service. If the installing dealer or distributor is unable to provide necessary parts, contact the nearest HHT authorized dealer or supplier. Additional service fees may apply if you are seeking Warranty service from a dealer other than the dealer from whom you originally purchased the applicable Product.
- No HHT consumer should bear cost of warranty service or costs incurred while servicing warranty claims (i.e., travel, gas, or mileage) when the service is performed within the terms of this Warranty. Check with your dealer or distributor in advance for any costs to you when arranging a warranty call. Travel and shipping charges for parts are not covered by this Warranty.

WARRANTY EXCLUSIONS:

This Warranty does not cover the following:

- Changes in surface finishes as a result of normal use. As a heating appliance, some changes in color of interior and exterior surface finishes may occur. This is not a flaw and is not covered under the Warranty.
- Damage to printed, plated, or enameled surfaces caused by fingerprints, accidents, misuse, scratches, melted items or other external sources and residues left on the plated surfaces from the use of abrasive cleaners or polishes.
- Repair or replacement of parts that are subject to normal wear and tear during the Warranty Period are not covered. These parts include: paint, wood and pellet gaskets, firebricks, wood grates, flame guides, batteries and the discoloration of glass.
- Minor expansion, contraction, or movement of certain parts causing noise. These conditions are normal and complaints related to this noise are not covered by this Warranty.
- Damages resulting from: (1) failure to install, operate, or maintain the applicable Product in accordance with the installation instructions, operating instructions, and listing agent identification label furnished with the applicable Product; (2) failure to install the applicable Product in accordance with local building codes; (3) shipping or improper handling; (4) improper operation, abuse, misuse, continued operation with damaged, corroded or failed components, accident, or improperly/incorrectly performed repairs; (5) environmental conditions, inadequate ventilation, negative pressure, or drafting caused by tightly sealed constructions, insufficient make-up air supply, or handling devices such as exhaust fans or forced air furnaces or other such causes; (6) use of fuels other than those specified in the operation instructions; (7) installation or use of components not supplied with the applicable Product or any other components not expressly authorized and approved by HHT; (8) modification of the appliance not expressly authorized and approved by HHT in writing; and/or (9) interruptions or fluctuations of electrical power supply to the applicable Product.
- Non-HHT venting components, hearth connections or other accessories used in conjunction with the applicable Product.
- Any part of a pre-existing fireplace system in which an insert or a decorative gas applicable Product is installed.
- HHT's obligation under this Warranty does not extend to the Product's capability to heat the desired space. Information is provided to assist the consumer and the dealer in selecting the proper Product for the application. Consideration must be given to the Product location and configuration, environmental conditions, insulation and air tightness of the structure.

This warranty is void if:

- The applicable Product has been over-fired, operated in atmospheres contaminated by chlorine, fluorine, or other damaging chemicals. Over-firing can be identified by, but not limited to, warped plates or tubes, deformation/warping of interior cast iron structure or components, rust colored cast iron, bubbling, cracking and discoloration of steel or enamel finishes.
- The applicable Product is subjected to prolonged periods of dampness or condensation.
- There is any damage to the applicable Product due to water or weather damage which is the result of, but not limited to, improper chimney or venting installation.

LIMITATIONS OF REMEDIES AND LIABILITY:

- **EXCEPT TO THE EXTENT PROVIDED BY LAW, HHT MAKES NO EXPRESS WARRANTIES OTHER THAN THE WARRANTY SPECIFIED HEREIN. The owner's exclusive remedy and HHT's sole obligation under this Warranty or in contract, tort or otherwise, shall be limited to, at HHT's sole option, replacement of the Component Part(s), repair of the Component Part(s), or refund of the original purchase price of the applicable Product(s). In no event will HHT be liable for any incidental or consequential damages caused by defects in the applicable Product. Some States do not allow the exclusion or limitation of incidental or consequential damages, so the above limitation or exclusion may not apply to you. This Warranty gives you specific legal rights and you may also have other rights which vary from State to State. THE DURATION OF ANY IMPLIED WARRANTY IS LIMITED TO DURATION OF THE EXPRESSED WARRANTY SPECIFIED ABOVE FOR THE APPLICABLE PRODUCT. Some States do not allow limitations on how long an implied warranty lasts, so the above limitation may not apply to you.**

2 Listing and Code Approvals

A. Appliance Certification

Model:	Pioneer III
Laboratory:	Underwriters Laboratories, Inc.
Report No:	Project 4788732172
Type:	Wood Fireplace
Standard:	UL 127 - 2011 and CAN/ULC S610-2018 (A1998) and (UM) 84-HUD, Manufactured Home Approved.

B. BTU & Efficiency Specifications

EPA Certified Emissions:	2.0 grams per hour
*LHV Tested Efficiency:	74.3%
**HHV Tested Efficiency:	69.1%
***EPA BTU Output:	14,700-72,800
Vent Size:	8 inches
Firebox Size:	4.06 cubic feet
Recommended Log Length:	24 inches
Fuel	Seasoned Cord Wood less than 20% moisture
*Weighted average LHV (Low Heating Value) efficiency using cord wood and data collected during EPA emission test. LHV assumes the moisture is already in a vapor state so there is no loss in energy to vaporize.	
**Weighted average HHV (High Heating Value) efficiency using cord wood and data collected during EPA emission test. HHV includes the energy required to vaporize the water in the fuel.	
***A range of BTU outputs based on HHV and the burn rates from the low and high EPA tests, using cord wood.	

The Pioneer III is Certified to comply with 2020 particulate emission standards.



The PIONEER III Wood Appliance meets the U.S. ENVIRONMENTAL PROTECTION AGENCY Certified to comply with 2020 particulate emission standards using cord wood.

This wood heater needs periodic inspection and repair for proper operation. It is against federal regulations to operate this wood heater in a manner inconsistent with operating instructions in this manual.

C. Mobile Home Approved

- This appliance is approved for mobile home installations when not installed in a sleeping room and when an outside combustion air inlet is provided.
- The structural integrity of the mobile home floor, ceiling, and walls must be maintained.
- The appliance must be properly grounded to the frame of the mobile home with #8 copper ground wire.
- Outside Air Kit must be installed in a mobile home installation.

D. Glass Specifications

This fireplace is equipped with 5mm ceramic glass. Replace glass only with 5mm ceramic glass. Please contact your dealer for replacement glass.

WARNING



Fire Risk.

Hearth & Home Technologies disclaims any responsibility for, and the warranty will be voided by, the following actions:

- Installation and use of any damaged appliance.
- Modification of the appliance.
- Installation other than as instructed by Hearth & Home Technologies.
- Installation and/or use of any component part not approved by Hearth & Home Technologies.
- Operating appliance without fully assembling all components.
- Do NOT Overfire - If appliance or chimney connector glows, you are overfiring.

Any such action that may cause a fire hazard.

Improper installation, adjustment, alteration, service or maintenance can cause injury or property damage.

For assistance or additional information, consult a qualified installer, service agency or your dealer.

NOTE: Hearth & Home Technologies, manufacturer of this appliance, reserves the right to alter its products, their specifications and/or price without notice.

Quadra-Fire is a registered trademark of Hearth & Home Technologies.

3 Important Safety and Operating Information

A. Fireplace Safety

Most problems are caused by improper installation and operation of the fireplace. To provide reasonable fire safety, the following should be given serious consideration:

- The fire should be supervised whenever the fireplace is in use.
- An annual inspection should be performed on the fireplace system.
- Install at least one smoke detector on each floor of your home to ensure your safety.
- Install a CO detector in the room with the fireplace.
- Install a conveniently located Class A fire extinguisher near the fireplace.
- Devise a practiced evacuation plan, consisting of at least two escape routes.
- Devise a plan to deal with a chimney fire:
 - Close all openings into the fireplace.
 - Evacuate.
 - Notify the fire department.

WARNING! Risk of Fire! *Hearth & Home Technologies disclaims any responsibility for, and the warranty and agency listing will be voided by the following actions.*

DO NOT:

- operate damaged fireplace
- modify fireplace
- overfire
- install any gas log set
- install any component not approved by *Hearth & Home Technologies*
- install parts or components not Listed or approved
- operate the fireplace without fully assembling all components

Improper installation, adjustment, alteration, service or maintenance can cause injury or property damage.

 **WARNING:** This product and the fuels used to operate this product (wood and wood pellets), and the products of combustion of such fuels, can expose you to chemicals including carbon black, which is known to the State of California to cause cancer and carbon monoxide, which is known to the State of California to cause birth defects or other reproductive harm. For more information go to: www.P65Warnings.ca.gov.

1. Clear Space

Combustible materials must not be stored on the hearth extension. Room furnishings such as drapes, curtains, chairs or other combustibles must be at least 4 ft (1219 mm) from the open front of the fireplace.

Combustible materials are materials made of or surfaced with any of the following materials:

- Wood
- Plant fibers
- Plywood/OSB
- Compressed paper
- Plastic
- Drywall
- Any material that can ignite and burn, flame proofed or not, plastered or un-plastered.

Non-combustible materials are materials which will not ignite and burn, composed of any combination of the following:

- Steel
- Brick
- Concrete
- Glass
- Iron
- Tile
- Slate
- Plasters

WARNING! Risk of Fire! *Keep combustible materials, gasoline and other flammable vapors and liquids clear of the fireplace.*

DO NOT:

- store flammable materials close to the fireplace
- use gasoline, lantern fuel, kerosene, charcoal lighter fluid or similar liquids to start or “freshen up” a fire in this fireplace.

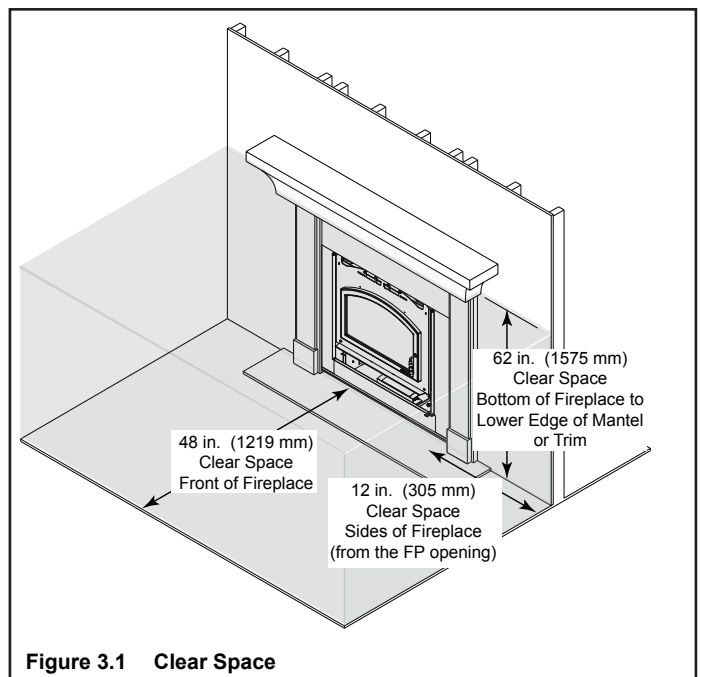

2. Firebrick

Your fireplace is lined with high quality firebrick, which has exceptional insulating properties.

Do not operate the fireplace without bricks. Make sure bricks are installed as shown in Section 5.

Do not use a grate; simply build a fire on the firebox floor.

3. Baffle and Blanket

Ensure correct baffle and baffle protection channel placement; replace baffle components if damaged or missing. (Please refer to Section 5.)

NOTICE: Firebox damage due to improper baffle placement is not covered by warranty. Operate the wood burning fireplace with the baffle in the correct position only. Not doing so could result in:

- reduced efficiency
- overheating the chimney
- overheating the rear of the firebox
- poor performance

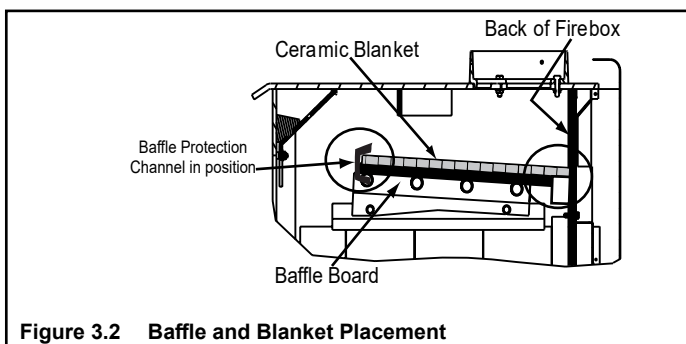

Figure 3.2 Baffle and Blanket Placement

The baffle board must be in contact with the manifold at the back of the firebox. The ceramic blanket should lay on top of the baffle board and manifold.

The baffle protection channel should be in position and cover the front of the blanket and baffle board.

4. Over-Firing Your Fireplace

DO NOT OVERFIRE THIS FIREPLACE UNIT

Attempts to achieve heat output rates that exceed design specifications can result in permanent damage to the fireplace.

To prevent over-firing your fireplace. **DO NOT:**

- use flammable liquids
- overload with wood
- burn trash or large amounts of scrap lumber
- permit too much air to the fire (leaving the door open)

Symptoms of over-firing may include one or more of the following:

- chimney connector or fireplace glowing
- roaring, rumbling noises
- loud cracking or banging sounds
- metal warping
- chimney fire

What to do if your fireplace is over-firing:

- Immediately close the door and air controls to reduce air supply to the fire.
- If you suspect a chimney fire, call the fire department and evacuate your house.
- Contact your local chimney professional and have your fireplace and chimney inspected for any damage.
- Do not use your fireplace until the chimney professional informs you it is safe to do so.
- Hearth & Home Technologies WILL NOT warranty fireplaces that exhibit evidence of over-firing. Evidence of over-firing includes, but is not limited to:
 - warped air tube
 - deteriorated refractory brick
 - deteriorated baffle and other interior components

5. Chimney Fire

In the event of a chimney fire:

- Have the chimney and adjacent structure inspected by qualified professionals. Hearth & Home Technologies recommends that NFI or CSIA certified professionals, or technicians under the direction of certified professionals, conduct a minimum of an **NFPA 211 Level 2** inspection of the chimney.
- Replace components of the chimney and fireplace as specified by the professionals.
- Ensure all joints are properly engaged and the chimney is properly secured.

WARNING! Risk of Fire! A chimney fire can permanently damage your chimney system. Failure to replace damaged components and make proper repairs can cause a structure fire.

WARNING



HOT SURFACES!

Glass and other surfaces are hot during operation AND cool down.

Hot glass will cause burns.

- **DO NOT** touch glass until it is cooled
- NEVER allow children to touch glass
- Keep children away
- CAREFULLY SUPERVISE children in same room as fireplace.
- Alert children and adults to hazards of high temperatures.

High temperatures may ignite clothing or other flammable materials.

- Keep clothing, furniture, draperies and other flammable materials away.

B. General Operating Parts

WARNING! DO NOT operate fireplace before reading and understanding operating instructions. Failure to operate fireplace according to operating instructions could cause fire or injury.

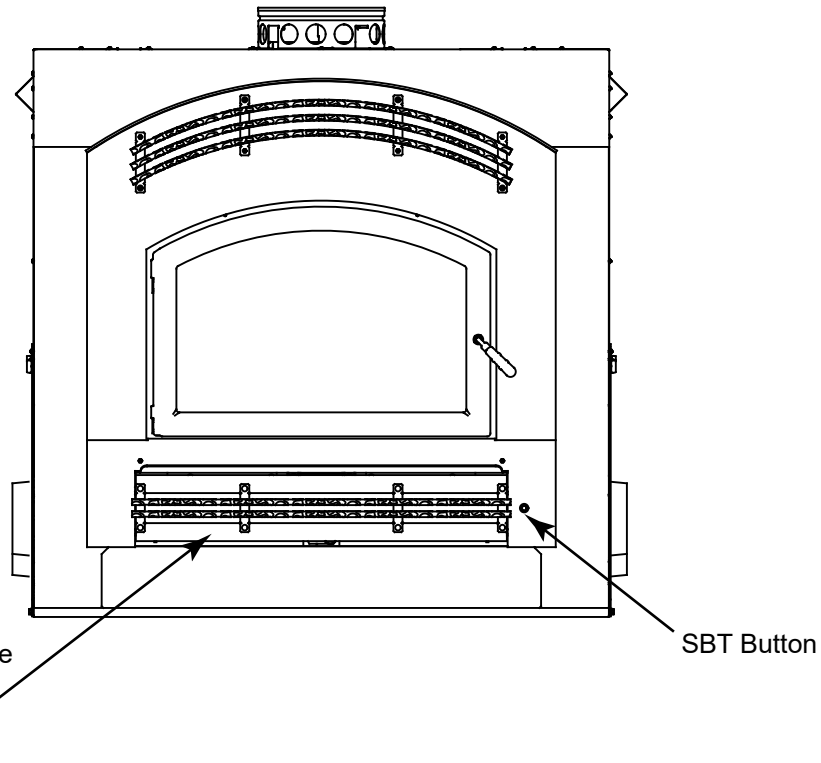

Figure 3.3 General Operating Parts

1. Smart Burn Technology (SBT)

The Smart Burn Technology system allows the thermostat to be set at the desired temperature, start the fire, load the appliance with wood and it will burn efficiently and clean with little interaction by the homeowner.

Battery Backup allows the appliance to operate without 110V but will not operate the fans.

The appliance can also be operated manually if necessary.

SMART Burn Technology Activation

Pushing the button will activate the appliance and open the air control to high.

Green Light

The green light illuminates when the button is pressed. This is indicating that the appliance is ready for a new fire or a reload. If neither of these events happens, the light will stay on for 2 hours and the air control will stay open. After 2 hours of no heat rise in the appliance then the light will go out and the air control closes to the zero position.

If a fire is started or the appliance is reloaded, the light will stay on through the warm up cycle. If the thermostat is calling for heat then the light stays green for as long as the appliance is burning on high.

No Light

The appliance will progress into a shutdown phase and slowly cool down and the light will turn off. Everything is working OK, but the SBT button will need to be pushed when reloading fuel.

Red Light

When the thermostat calls for heat while the appliance is in charcoal phase, the air control will open all the way and the red light illuminates. This is indicating that the appliance is trying to heat the room but there is only charcoal left and needs reloaded.

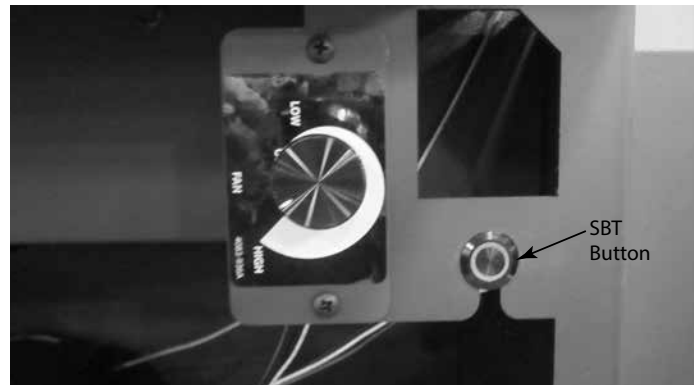

Figure 3.4

2. Thermostat Location and Wiring to Fireplace

The kit comes with a programmable wall thermostat (C1) and 25' of thermostat wire (C2). If you need to run more than 25' make sure you use a continuous strand of 18 to 22 gauge thermostat wire. For optimum performance your thermostat should be:

- Mounted on an inside wall, approximately 5' above the floor
- Do not locate where there is poor air circulation such as in a corner, alcove, behind doors, bookcase or other objects
- Located away from drafts, direct sunlight, above a lamp, television, radiator, a wall next to a window, or direct heat from the appliance
- Avoid damp environments as this can lead to corrosion that may shorten thermostat life
- If painting or construction work around, cover the thermostat completely or wait until work is complete before installation.
- The thermostat wire will be installed on the opposite side of where the electric comes in at. See Figure 3.6.

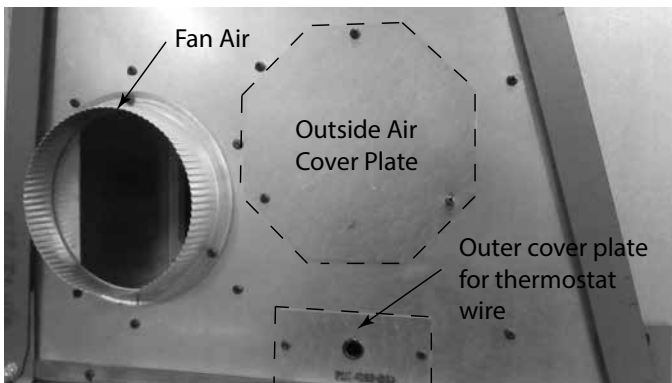

Figure 3.6 Left Side Shown

- Remove the outer thermostat wire cover plate and insert the end of the wire with the spade ends on it through the hole in the cover plate. See Figure 3.6. Continue inserting the wire into the fireplace and through the hole in the inner cover plate. See Figure 3.7.

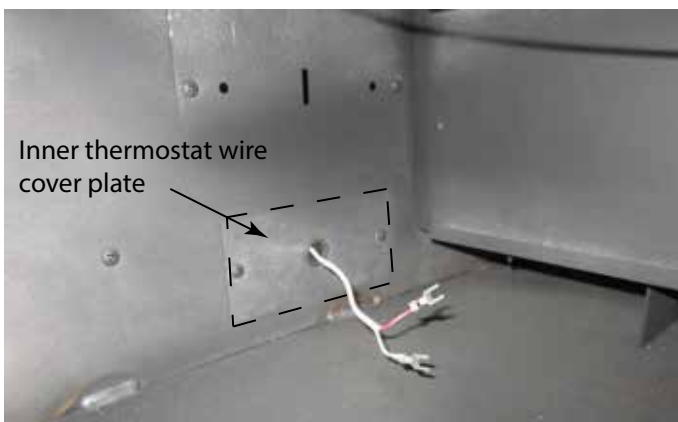

Figure 3.7

- Open the lower access panel on the front of the fireplace. Locate the end of the thermostat wire and run it in through from the back of the large hole and up to and attach it to the terminal block. See Figure 3.8.

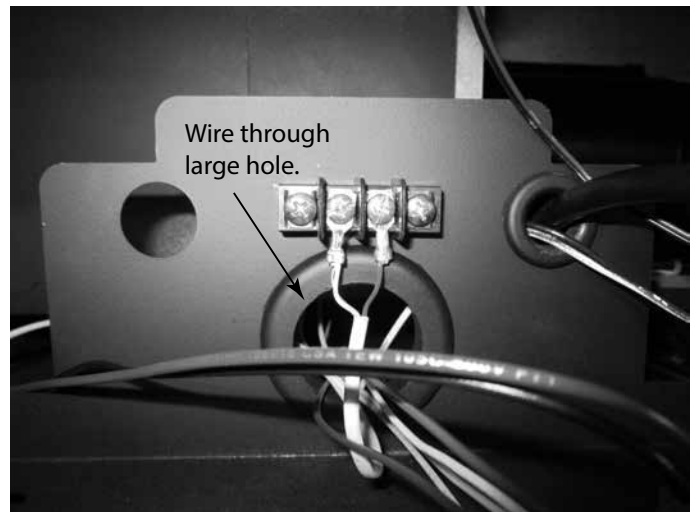

Figure 3.8

- Reinstall outer thermostat cover plate. See Figure 3.9.

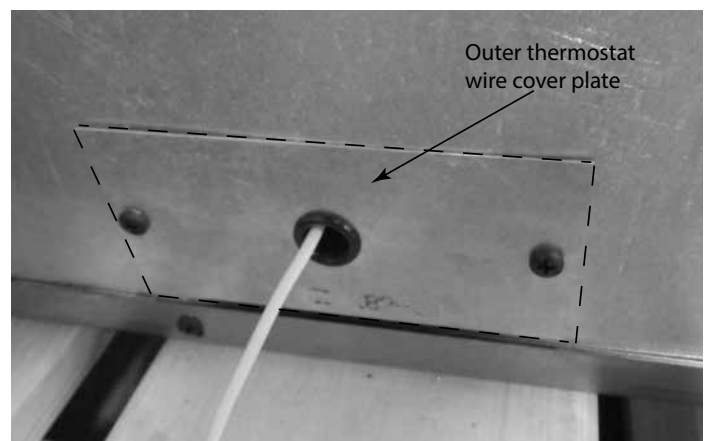

Figure 3.9 Thermostat wire installed through outer cover plate

3. Thermostat Controls

Reference instruction sheet supplied with thermostat.

STATIC NOTICE

Thermostat is protected against normal static electric discharges, however to minimize the risk of damaging the thermostat in extremely dry weather, please touch a grounded metal object before touching the thermostat.

4. Outside Air

NOTICE: Use of outside air is required.

CAUTION! Outside air control handle may be warm. Allow unit to cool down before closing.

A source of air (oxygen) is required in order for combustion to take place.

1. Before lighting the fire open the bottom access panel by lifting it up and pulling it down.
2. Locate the handle on either the left or right side. Lift the handle up and pull out to open the door (pushing the handle in will close the door).
3. Before closing the bottom access panel, make any adjustments to the convection fan (see step 6).

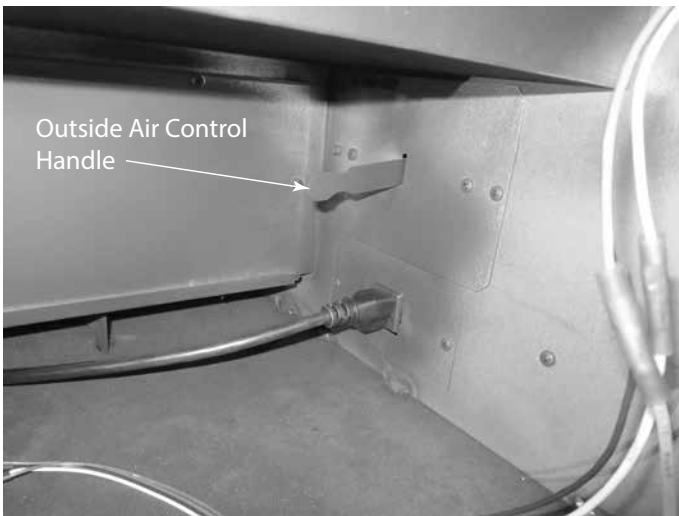

Figure 3.17 Outside Air Control Handle

5. Glass Door

This fireplace has been tested and is intended for use with the door as supplied with this fireplace.

WARNING! Risk of Fire and Smoke! Fireplace should be operated only with doors fully open or door fully closed. If the door is left partly open, gas and flame may be drawn out of the fireplace opening.

WARNING! Fire Risk!

- Do not use glass door to hold burning material in fireplace.

Glass may break or burning material may roll out.

WARNING! RISK OF Fire! Do NOT install and or use any component not approved by Hearth & Home Technologies.

6. Convection Fan Operation

(Located behind the lower access door)

The high fan speed can be decreased by turning the knob counterclockwise. The fan speed will vary automatically based on the temperature of the appliance. The fan can be turned off by manually turning the knob counterclockwise to the off position. See Figure 3.18.

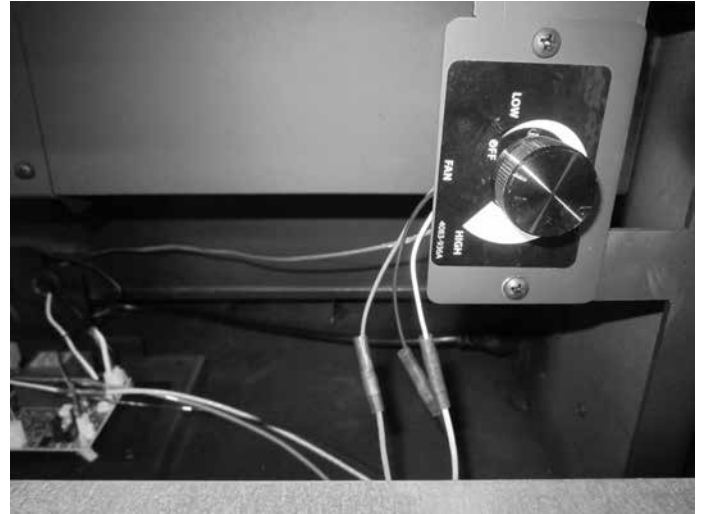

Figure 3.18 Fan Speed Control

7. Battery Holder

The battery holder holds eight (8) D cell batteries and will allow the appliance to operate without 110V. (The fan will not operate on batteries only.)

1. Open the control access door.
2. Remove the control board cover. See Figure 3.19



Figure 3.19 Control Board Cover

3. Install the batteries. See Figure 3.20

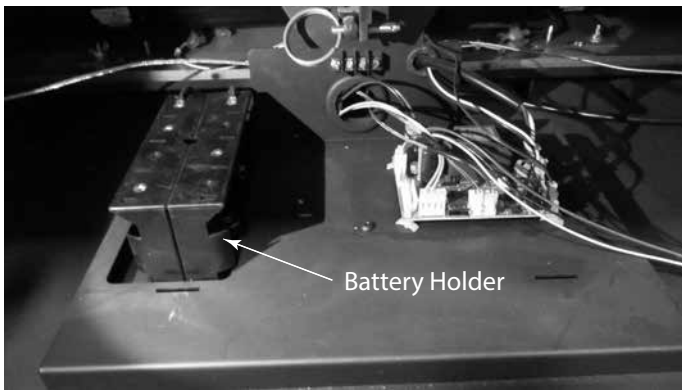

Figure 3.20 Install Batteries

4. Reverse the previous steps.

The batteries will allow the appliance to operate 30 days or more without power.

C. Fuel

WARNING! For use with solid wood fuel only.

Other fuels may overfire and generate poisonous gases (i.e. carbon monoxide).

This fireplace is designed to burn natural wood only. Higher efficiencies and lower emissions generally result when burning air dried seasoned hardwoods, as compared to softwoods or to green or freshly cut hardwoods. **DO NOT BURN:**

- Garbage
- Lawn clippings or yard waste
- Materials containing rubber, including tires
- Materials containing plastic
- Waste petroleum products, paints or paint thinners, or asphalt products
- Materials containing asbestos
- Construction or demolition debris
- Railroad ties or pressure-treated wood
- Manure or animal remains
- Salt water driftwood or other previously salt water saturated materials
- Unseasoned wood
- Paper products, cardboard, plywood, or particleboard. The prohibition against burning these materials does not prohibit the use of fire starters made from paper, cardboard, saw dust, wax and similar substances for the purpose of starting a fire in an affected wood heater.

Burning these materials may result in release of toxic fumes or render the heater ineffective and cause smoke.

1. Hardwood vs. Softwood

Your fireplace's performance depends on the quality of the firewood you use. One species of wood varies very little to the other in terms of energy content. All seasoned wood contains about 8,000 BTU's per pound. Hardwoods have a greater density than softwoods; a piece of hardwood will contain about 60% more BTU's than an equal size piece of softwood. A cord of seasoned oak (hardwood) would contain about 60% more potential energy than a cord of seasoned pine (softwood).

Most softwoods are coniferous. These are trees with needle-like leaves that stay green all year and carry their seeds exposed in a cone. Examples of coniferous trees are Douglas fir, pine, spruce and cedar. Softwoods, being more porous, require less time to dry, burn faster and are easier to ignite than hardwoods. Hardwoods are deciduous trees, broadleaf trees that lose their leaves in the fall. Their seeds are usually found within a protective pod or enclosure. Some examples of deciduous trees are oak, maple, apple, and birch. However, it should be noted that there are some deciduous trees that are definitely not considered hardwoods such as poplar, aspen and alder. Hardwoods require more time to season, burn slower and are usually harder to ignite than softwoods. Obviously, you will use the type of wood that is most readily available in your area. However, if at all possible the best arrangement is to have a mix of softwood and hardwood. This way you can use the softwood for starting the fire, giving off quick heat to bring the fireplace up to operating temperature. Add the hardwood for slow, even heat and longer burn time.

WARNING! Risk of Fire!

- **DO NOT** burn wet or green wood.
- Wet, unseasoned wood can cause accumulation of creosote.

Soft woods	Hard woods
• Douglas Fir	• Oak
• Pine	• Maple
• Spruce	• Apple
• Cedar	• Birch
• Poplar	
• Aspen	
• Alder	

2. Moisture Content

The majority of the problems fireplace owners experience are caused by trying to burn wet, unseasoned wood. Freshly cut wood can be as much water as it is wood, having a moisture content of around 50%. Imagine a wooden bucket that weighs about 8 pounds. Fill it with a gallon of water, put it in the firebox and try to burn it. This sounds ridiculous but that is exactly what you are doing if you burn unseasoned wood. Dead wood lying on the forest floor should be considered wet, and requires full seasoning time. Standing dead wood can be considered to be about two-thirds seasoned, if cut at the dry time of the year.

Burning wet, unseasoned wood will produce less heat output because it requires energy in the form of heat to evaporate the water trapped inside. This is wasted energy that should be used for heating your home. This moisture evaporates in the form of steam which has a cooling effect in your firebox and chimney system. When combined with tar and other organic vapors from burning wood it will form creosote which condenses in the relatively cool firebox and chimney.

Even dry wood contains at least 15% moisture by weight, and should be burned hot enough to keep the chimney hot for as long as it takes to dry the wood out - about one hour. To tell if wood is dry enough to burn, check the ends of the logs. If there are cracks radiating in all directions from the center, it is dry. If your wood sizzles in the fire, even though the surface is dry, it may not be fully cured.

3. Seasoning

Seasoned firewood is nothing more than wood that is cut to size, split and air dried to a moisture content of around 20%. The time it takes to season wood varies from around nine months for soft woods to as long as eighteen months for hardwoods. The key to seasoning wood is to be sure it has been split, exposing the wet interior and increasing the surface area of each piece. A tree that was cut down a year ago and not split is likely to have almost as high a moisture content now as it did when it was cut.

To season wood:

- Cut logs to size
- Split to 6 in. (152 mm) or less
- Air dry to a moisture content of around 20%
 - Soft wood - about nine months
 - Hard wood - about eighteen months

NOTICE: Seasoning time may vary depending on drying conditions.

4. Storing Wood

Splitting wood before it is stored reduces drying time. The following guideline will ensure properly seasoned wood:

- Stack the wood to allow air to circulate freely around and through the woodpile.
- Elevate the woodpile off the ground to allow air circulation underneath.
- The smaller the pieces, the faster the drying process. Any piece over 6 in. (152 mm) in diameter should be split.
- Wood should be stacked so that both ends of each piece are exposed to air, since more drying occurs through the cut ends than the sides. This is true even with wood that has been split.
- Store wood under cover, such as in a shed, or covered with a tarp, plastic, tar paper, sheets of scrap plywood, etc., as uncovered wood can absorb water from rain or snow, delaying the seasoning process. Avoid covering the sides and ends completely. Doing so may trap moisture from the ground and impede air circulation.

5. Burning Process

Fire requires fuel, air and heat. If heat is robbed from the fireplace during the drying stage, the new load of wood has reduced the chances for a good clean burn. Always burn dry, seasoned firewood.

• Kindling or 1st stage:

In this stage, the wood is heated to a temperature high enough to evaporate the moisture which is present in all wood. The wood will reach the boiling point of water (212°F) and will not get any hotter until the water is evaporated. This process takes heat from coals and tends to cool the fireplace.

• 2nd stage:

The secondary stage is when the wood gives off flammable gases which burn above the fuel with bright flames. It is very important that the flames be maintained and not allowed to go out. This will ensure the cleanest possible fire. You should close down the air to control the point where you can still maintain some flame. If the flames tend to go out, more air is necessary.

• Final stage:

The final stage of burning is the charcoal stage. This occurs when the flammable gases have been mostly burned and only charcoal remains. This is a naturally clean portion of the burn. The coals burn with hot blue flames.

It is very important to reload your fireplace while enough lively hot coals remain in order to rekindle the next load of wood.

6. Dirty Glass

A portion of the combustion air entering the firebox is deflected down over the inside of the door glass. This air flow “washes” the glass, helping to keep smoke from adhering to its surface. When operated at a low burn rate, less air will be flowing over the glass and the smoky, relatively cool condition of a low fire will cause the glass to become coated. Operating the fireplace with the burn rate air control and start-up air control all the way open for 15-20 minutes should remove the built up coating.

7. Creosote Formation and Need For Removal

When wood is burned slowly, it produces tar and other organic vapors which combine with expelled moisture to form creosote. The creosote vapors condense in the relatively cool chimney flue of a newly-started or a slow-burning fire. As a result, creosote residue accumulates on the flue lining.

When ignited, creosote creates an extremely hot fire which may damage the chimney or even destroy the house.

The chimney shall be inspected at least annually before lighting, or once every two months during heating season.

When creosote has accumulated it shall be removed to reduce the risk of a chimney fire.

8. Opacity

Opacity indicates how cleanly your fireplace is burning. Opacity is measured in percent; 100% opacity is when an object is totally obscured by the smoke column from a chimney, and 0% opacity means that no smoke column can be seen. Periodically check the opacity and burn your fireplace as nearly smoke-free as possible (goal of 0% opacity).

D. First Fire

Before lighting your first fire in the fireplace, make certain that:

- the baffle and ceramic blanket are correctly positioned, resting against the rear support
- firebrick are in place
- all labels have been removed
- all plated surfaces have been cleaned

NOTICE: Oils can cause permanent markings on plating if not removed before the first fire.

NOTICE: The first three or four fires should be of moderate size to allow the oils and binders to be burned from the fireplace and the refractory and paint to cure. You may notice an industrial odor the first few fires. This is considered normal.

E. Lighting Instructions/Establish Coal Bed

- Open outside air by opening the lower access panel and locate the outside air handle (it could be on the left or right). Lift the handle up and pull out to open. See Figure 3.21.

Note: This may be closed only when the fireplace is not in use to prevent cold air infiltration.

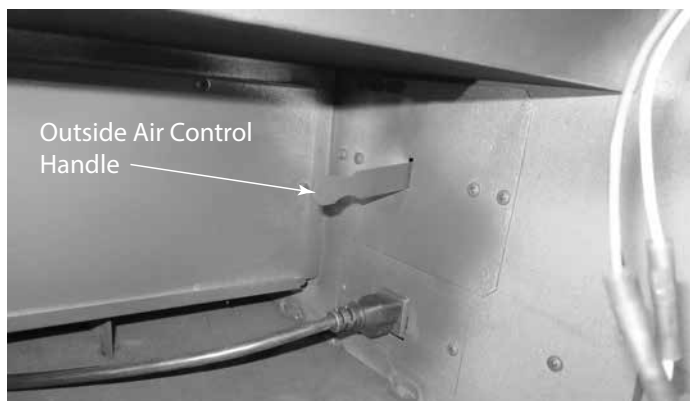

Figure 3.21 Outside Air Handle Shown on Right Side

- Set the thermostat to the desired temperature. Push the SBT button (the air control will open and the light should illuminate green).
- Place several wads (4-5 pieces) of crumpled newspaper on the firebox floor. Add 7-8 lbs. of kindling (pieces of dry cord wood less than 1 inch in diameter) stacked on top of the paper crisscrossed. See Figure 3.22.
- Make sure that no matches or other combustibles are in the immediate area of the fireplace. Be sure the room is adequately ventilated and the flue unobstructed.
- For best results, use a hand held homeowner-type gas torch to light the paper and wood for approximately one minute.
- Leave the door slightly open 1-2 inches (see Figure 3.26)



Figure 3.22 Placing Kindling

- for 2-3 minutes then close the door, latching it lightly. Then push the SBT button. See Figure 3.27.
- After the flame gets established (approximately 5-6 minutes) shut and latch the door. Then push the SBT button. See Figure 3.28.
- When 1/2 to 2/3 of the kindling burns down, open the door, push the SBT button and level the firebox.
- Add 11 to 12 pounds of start-up wood (1-3 inch diameter pieces of cord wood) by stacking them in a crisscross pattern. This will allow for proper air flow.
- Leave door slightly open 1-2 inches (see Figure 3.26) for 1-3 minutes or until a good flame is present. Then close the door, latching it lightly. Then push the SBT button. See Figure 3.27.
- After the flame gets established (approximately 3-5 minutes) shut and latch the door. Then push the SBT button.
- When the kindling has burned down 1/2 to 2/3 and a good flame is still present, push the SBT button and open the door. Level the coal bed insuring that the combustion air holes are not blocked.

High Burn

- Load 5-6 pieces of cord wood 24 inches long to achieve maximum firebox volume, stack 2 to 3 pieces high in the back first, then 2 to 3 pieces in the front, making sure to work the bottom pieces into the coal bed to insure solid stack once all the wood is loaded. Leave at least a 1 inch gap between the two stacks to insure good air flow around the wood. See Figures 3.22, 3.24 & 3.25 for examples.
- Leave the door slightly open 1-2 inches (see Figure 3.26) for 2 to 3 minutes to get a good flame going then close the door, latching it lightly and push the SBT button. See Figure 3.27.



Figure 3.23 Loading Wood

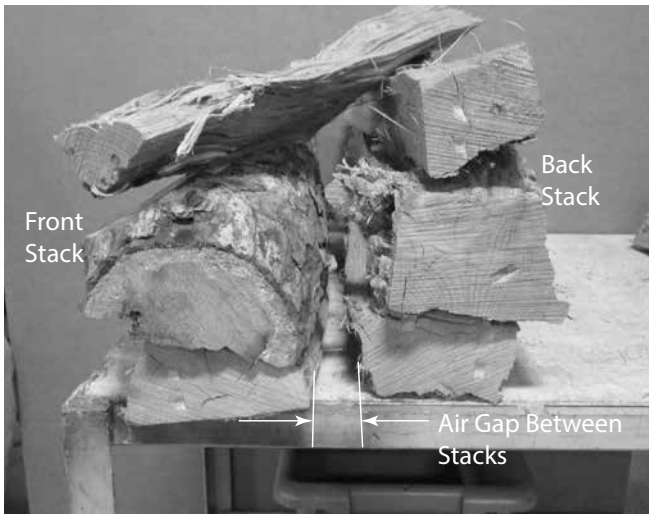

Figure 3.24 Stacking Wood



Figure 3.26 Door Open 1-2 Inches

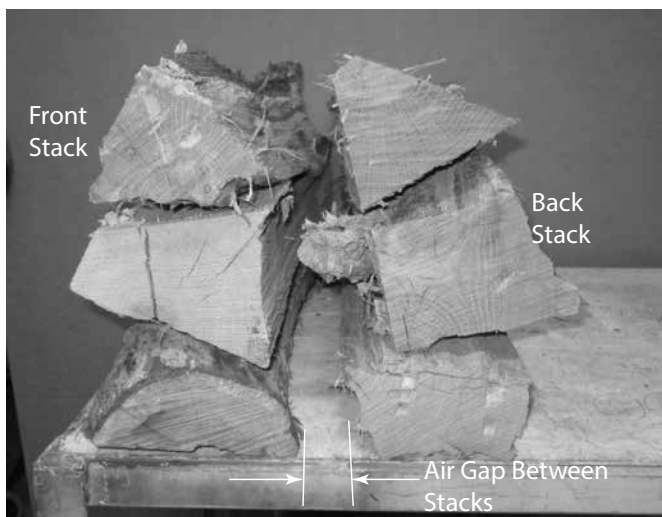

Figure 3.245 Stacking Wood



Figure 3.27 Door Latched Lightly



Figure 3.28 Door Fully Closed

- After about 5 minutes, close and latch the door completely then push the SBT button again. See Figure 3.28.

Maximum Heat

Setting the thermostat at a temperature above what the room will achieve, for example, 90° on the thermostat will cause the appliance to burn continuously on high. Press the activation button to activate the system and load fuel.

Medium Burn

- When away during daytime hours and unattended set the thermostat to a temperature below what the room temperature will drop to, for example, 45° and then program the thermostat to turn back on to a higher desired temperature (example 75°) after 13 hours. Time will vary depending on house size. Load fireplace by referring to the High Burn section.

Low Burn

- During evenings and overnight, set the thermostat to a temperature below what the room temperature will drop to, for example 45° and then program the thermostat to turn back on to a higher desired temperature (example 75°) after 16-1/2 hours. Time will vary depending on house size. Load fireplace by referring to the High Burn section.

Reloading the Appliance

- If the light is red or the appliance needs more fuel, push the button, open the door slowly, stir up the coals, load the wood and shut the door.
- When the activation button is pushed, regardless of the temperature set on the thermostat, the appliance will burn on high and go through the high burn cycle until the appliance has warmed up and reached the maximum operating temperature. If the thermostat is not calling for heat, the appliance will progress to low burn setting and continue burning at that rate until the thermostat calls for heat (the room temperature is less than the thermostat is set for).

F. Heat Output Control

The Pioneer III is designed to operate with a programmable wall thermostat. Set the desired room temperature on the thermostat and the appliance heat output will adjust as necessary to maintain the room temperature.

WARNING! Risk of Fire!

This wood appliance has manufacturer-set minimum low burn rate that must not be altered. It is against federal regulations to alter this setting or otherwise operate this wood appliance in a manner inconsistent with operating instructions in this manual.

G. Manual Override of Air Control

The appliance can be operated manually if necessary when electricity or batteries are not available. It is necessary to remove the front actuator pin and manually control the Air Control located inside the bottom access panel.

CAUTION

The Air Control may become HOT to touch. Use gloves or tool to adjust.

1. Open the Control Access Door
2. Remove the front Actuator Pin by grasping the ring and pulling sideways
3. The Air Control will move freely forward and backward
4. Pushing the Air Control towards the back of the appliance is high
5. Pulling the Air Control towards the front will reduce the burn rate.

The Actuator Pin should be installed when the electricity or batteries have been restored.

1. Align the hole in the Air Control with the hole in the Actuator
2. Insert the Actuator Pin

WARNING! Risk of Fire! *Keep combustible materials, gasoline and other flammable vapors and liquids clear of the fireplace.*

DO NOT:

- store flammable materials close to the fireplace
- use gasoline, lantern fuel, kerosene, charcoal lighter fluid or similar liquids to start or "freshen up" a fire in this fireplace. The results can be fatal.

Keep all flammable liquids well away from the fireplace while it is in use. Combustible materials may ignite.

H. Frequently Asked Questions

ISSUES	SOLUTIONS
Odor from appliance	When first operated, this appliance may release an odor for the first several hours. This is caused by the curing of the paint and the burning off of any oils remaining from manufacturing.
Metallic noise	Noise is caused by metal expanding and contracting as it heats up and cools down, similar to the sound produced by a furnace or heating duct. This noise does not affect the operation or longevity of the appliance.
Whirring sound	The fan produces a whirring sound which increases in volume as the speed is increased.

CONTACT YOUR DEALER for additional information regarding operation and troubleshooting.
Visit www.fireplaces.com to find a dealer.

WARNING

DO NOT PLACE COMBUSTIBLE OBJECTS IN FRONT OF THE APPLIANCE. High temperatures may ignite clothing, furniture or draperies.

WARNING



Fire Risk.

- DO NOT BURN GARBAGE OR FLAMMABLE FLUIDS SUCH AS GASOLINE, NAPHTHA OR ENGINE OIL.
 - Do NOT burn treated wood or wood with salt (driftwood).
 - May generate carbon monoxide if burn material other than wood.
- May result in illness or possible death.

NOTE: Home owners are encouraged to provide smoke and carbon monoxide detectors in accordance with the authority having jurisdiction.

WARNING



Fire Risk.

Keep combustible materials, gasoline and other flammable vapors and liquids clear of appliance.

- Do NOT store flammable materials in the appliance's vicinity.
- DO NOT USE GASOLINE, LANTERN FUEL, KEROSENE, CHARCOAL LIGHTER FLUID OR SIMILAR LIQUIDS TO START OR "FRESHEN UP" A FIRE IN THIS HEATER.
- Keep all such liquids well away from the heater while it is in use.
- Combustible materials may ignite.

I. Quick Start Guide

**TURN YOUR THERMOSTAT ON
PROGRAM YOUR THERMOSTAT



1

**PUSH SMART BURN
TECHNOLOGY (SBT)
ACTIVATION BUTTON**

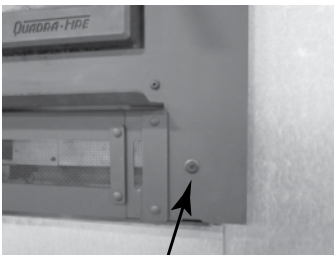

**LOWER RIGHT CORNER
OF FACE**

2

**LOAD PAPER & KINDLING ON
TOP AND LIGHT**



3

***LEAVE DOOR AJAR UNTIL
FIRE IS ESTABLISHED**



4

**PUSH SBT BUTTON, ADD
MORE WOOD, CLOSE AND
LATCH DOOR**

5

**Refer to Owner's Manual or use and care video on how to program

*Starting a fire may not require an open door for draft.

LED Operation

Light	What To Do
Green	Everything OK; air control is fully open.
None	Everything OK; push button when reloading fuel.
Red	Calling for heat, push button and load fuel.
2 fast red blinks then no color for 1 second	Left thermocouple error, call your dealer.
3 fast red blinks then no color for 1 second	Right thermocouple error, call your dealer.
1 red blink every 1/2 second continually	Overfire indication; do not load fuel. Call your dealer.

WARNING! RISK OF FIRE

Close and securely latch the door after the fire has started, and after refueling, to prevent:

- Spillage of smoke, flame and carbon monoxide
- Spillage of sparks, coals and logs
- Over-firing

DO NOT leave the appliance unattended with the door open.

4 Maintenance and Service

This fireplace needs periodic inspection and repair for proper operation. It is against federal regulations to operate this fireplace in a manner inconsistent with operating instructions in this manual.

WARNING! Hot Surfaces!

Glass and other surfaces are hot during operation AND cool down. DO NOT clean fireplace until it is cooled.

Task	Frequency	To be completed by
1. Chimney Inspection	As needed	Homeowner or Chimney Sweep
2. Chimney Cleaning	As needed	Chimney Sweep
3. Plated Surfaces Cleaning	As needed	Homeowner
4. Glass Door	Seasonally	
5. Glass Cleaning	As needed	
6. Door Gasket	Seasonally	
7. Ash Removal	As needed	
8. Baffle/Blanket/Channel Protector	Seasonally	
9. Firebrick	Seasonally	

A. Maintenance Tasks-Homeowners

Installation and repair should be done by a qualified service technician only. The fireplace should be inspected before use and at least annually by a professional service person.

The following tasks may be performed annually by the homeowner. If you are uncomfortable performing any of the listed tasks, please call your dealer for a service appointment.

1. Chimney Inspection

Frequency: As necessary; at least annually before lighting fireplace, or once every two months during heating season.

By: Homeowner/Chimney Sweep

- Confirm that termination cap remains clear and unobstructed.
- Inspect for blockages such as bird nests, leaves, etc.
- Inspect for corrosion or separation.
- Inspect for creosote and remove as needed, at least every two months during the heating season.
- Inspect the system at the fireplace connection and at the chimney top.

In the event of a chimney fire, Hearth & Home Technologies recommends replacement of the chimney and inspection of the adjacent structure to the provisions of NFPA Level III inspection criteria.

WARNING! Risk of Asphyxiation and Fire! Annual inspection by qualified technician recommended.

Check:

- *condition of door, surrounds and fronts*
- *condition of glass and glass assembly*
- *obstructions of combustion and ventilation air*
- *obstructions of termination cap*

Clean:

- *glass*
- *air passageways, grilles*

2. Creosote (Chimney) Cleaning

Frequency: As needed; at least annually before lighting, or once every two months during heating season. When creosote has accumulated it shall be removed to reduce the risk of a chimney fire.

By: Chimney Sweep

Tools Needed: Brush, Phillips screwdriver

- When wood is burned slowly, it produces tar and other organic vapors, which combine with expelled moisture to form creosote. The creosote vapors condense in the relatively cool chimney flue of a slow-burning fire. As a result, creosote residue accumulates on the flue lining. When ignited, this creosote makes an extremely hot fire.
- Remove all ash from the firebox and extinguish all hot embers before disposal. Allow the fireplace to cool completely.
- Remove baffle and ceramic blanket from fireplace before cleaning chimney (refer to Section 5.C.3 Baffle Removal and Installation).
- Close the door tightly.
- Remove the top of the termination cap as shown in Figure 4.1 to clean the cap and chimney.
- The creosote or soot should be removed from the chimney with a brush specifically designed for the size of chimney in use.
- Reinstall termination cap.
- Clean out fallen debris from the firebox.
- Replace baffle and ceramic blanket.

WARNING! Risk of Fire! Ignited creosote is extremely HOT. Prevent creosote buildup.

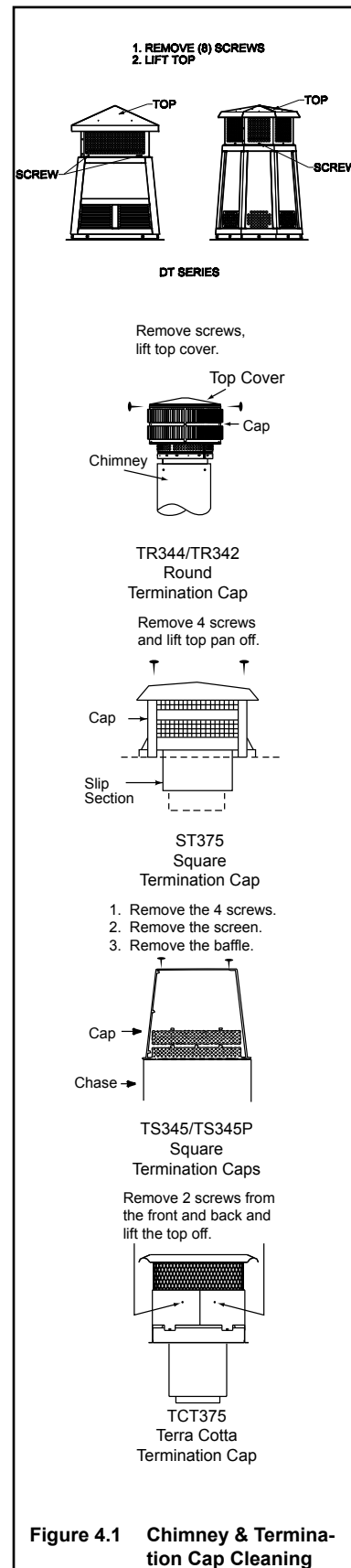

3. Care and Cleaning of Plated Surfaces

Frequency: Initially and as needed

By: Homeowner

Tools Needed: Vinegar or glass cleaner, soft towel

CAUTION! Do not use a polish with abrasives. It will scratch plated surfaces.

- Use a glass cleaner or vinegar and towel to remove the oils.
- Oils can cause permanent markings on plating if not removed.
- After plating is cured, oils will not affect the finish.

4. Glass Door

Frequency: As necessary

By: Homeowner

- Inspect glass panel for cracks. Replace if this condition is present.
- Inspect glass gasket. Confirm glass does not move around in glass frame.

5. Glass Cleaning

Frequency: As necessary

By: Homeowner

Tools Needed: Vinegar or glass cleaner, soft towel

- Clean glass with a non-abrasive glass cleaner. Use a damp cloth dipped in wood ashes or a commercially available oven cleaner. Remove any oven cleaner residue with a glass cleaner or soap and water.

6. Door Gasket

Frequency: Seasonally

By: Homeowner

- Open door, place half a dollar bill inside and close the door.
- Attempt to pull the bill out.
- If the bill gives good resistance or is not removable, the gasket is adjusted correctly. If the bill is easily removed, the gasket needs adjustment or replacement to create an even seal all around door.

It may be necessary to adjust or tighten the door latch.

7. Ash Removal

Frequency: As necessary

By: Homeowner

Tools Needed: Covered metal container, metal shovel, fireplace broom

WARNING! Risk of Fire! DO NOT remove ashes until the fire is out and the fireplace is cold.

- Ashes should be placed in metal container with tight fitting lid.
- The closed container of ashes should be placed on a noncombustible floor or on the ground, well away from all combustible materials, pending final disposal.
- If the ashes are disposed of by burial in soil or otherwise locally dispersed, they should be retained in the closed container until all cinders have thoroughly cooled.

8. Baffle and Blanket

Frequency: As necessary

By: Homeowner

Tools Needed:

- Ensure correct baffle and baffle protection channel placement; replace baffle components if damaged or missing.
- The ceramic blanket and baffle board **MUST** be in contact with the back of the firebox and even with each other in the front. The baffle protection channel **MUST** be in position. Refer to Section 3.A.3.

9. Firebrick

Frequency:

By:

Tools Needed:

- Inspect condition of brick. Replace if crumbly or otherwise deteriorated, or if cracks exceed 1/4 in. (6 mm).

B. Replacement Maintenance

1. Glass Replacement

- Ensure that the fire is out and the fireplace is cool to the touch.
- Protect a table or counter top with padding or towels.
- Open the door and while supporting it, remove the (2) top hinge screws and retainer, lift door up and off.
- Lay door face down on table or counter making sure handle and handle attachment knob hang over the edge of the table top so door lays flat on the soft surface.
- Remove screws from the top and bottom glass frame (12 screws) using a #2 Phillips Head screwdriver. Set frame aside and retain screws.
HINT: Soak screws in penetrating oil for easy removal.
- Remove the glass and discard.
- Position the new glass with gasket into the door.
- Replace the glass frames.
- Start screws to secure glass frame to door, keeping them loose for adjusting the glass. Then continue to tighten each screw alternately, a few turns at a time, until the glass panel is tightened snugly. **DO NOT OVERTIGHTEN OR CROSS THREAD SCREWS.**
- Replace the door on the fireplace.
- After the first burn, recheck the tightness of the screws.

NOTICE: Remove all labels from glass before lighting the first fire in your fireplace.

CAUTION!

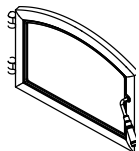

Handle glass assembly with care.

When cleaning glass:

- Avoid striking, scratching or slamming glass.
- Do NOT clean glass when hot.
- Do NOT use abrasive cleaners.
- Use a hard water deposit glass cleaner on white film.
- **Refer to maintenance instructions.**



WARNING



Injury Risk.

- Use only glass specified in manual.
- **DO NOT REPLACE** with any other material.

2. Tighten or Adjust Door Latch

Remove the lock nut holding latch cam and one or two spacing washers on the door as shown in Figure 4.2. Reinstall the cam and tighten locknut.

OR

Replace the gasket material. Wear or damage to the gasket material can cause air leakage into the firebox resulting in overfiring and loss of efficiency.

A replacement gasket is available from your dealer.

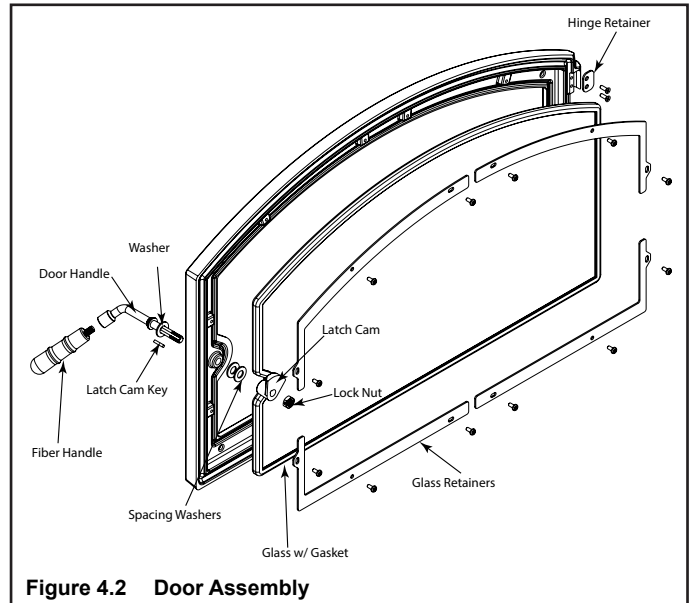

Figure 4.2 Door Assembly

3. Manifold Tubes Removal and Replacement

- Remove all ash from the firebox disposing of it in a metal container.
- The manifold tubes are located in the upper portion of the inside of the firebox.
- Each tube is attached with one 3/16" stainless steel hex head screw attached to the firebox on the left hand side. The right hand side of the tube just slides into a hole.
- Please note that each tube is different in regards to the air holes or mounting holes.
- Remove the hex head screw and clip. Slide the tube to the right, angle down and pull out. It is recommended to replace one tube at a time to insure correct placement.

4. Door Handle Assembly

- Slide door handle through door.
- Install washer(s) as shown in Figure 4.3.
- Install key groove.
- Align groove in latch cam with key; slide latch cam over shaft.
- Install locknut but do not overtighten, the handle needs to move smoothly.
- Install fiber handle using a clockwise motion until the fiber handle is snug against the door handle shaft.

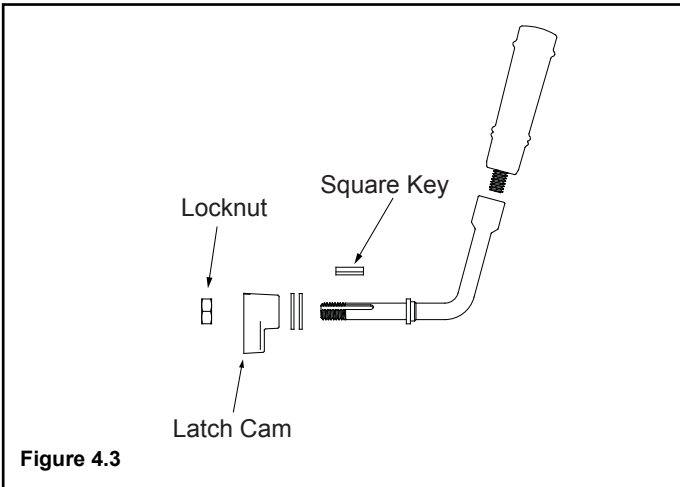

Figure 4.3

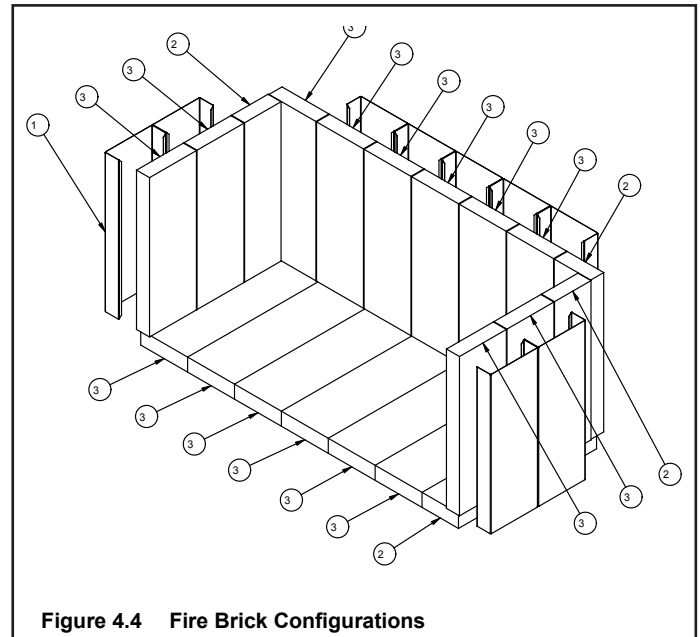

Figure 4.4 Fire Brick Configurations

#	Brick Size	Qty. in Set
1	Brick Wrap	9
2	Firebrick 13.25 x 3.50 x 1.25	4
3	Firebrick 13.25 x 4.50 x 1.25	16

5. Firebrick Replacement

The firebox of your fireplace is lined with high quality firebrick and refractory board under the bottom firebrick only, which has exceptional insulating properties. There is no need to use a grate; simply build a fire on the firebox floor. Do not operate the fireplace without bricks.

IMPORTANT: The bricks are very similar in size. Be certain you have the proper brick in the correct location. Measure the brick size for accuracy.

After the coals are completely cooled, remove all old firebrick and ash from unit and vacuum out firebox.

- Remove new brick set from box and lay out to diagram shown in Figure 4.4.
- If the bottom refractory board needs replacing, do so at this time.
- Lay bottom bricks in unit.
- Install rear bricks on the top of the bottom bricks. Slide top of bricks under clip on back of firebox wall and push bottom of brick back.
- Install side bricks. Slide top of brick under clips on side of firebox and push the bottom of the brick until it is flush with the side of the unit.

6. Thermocouple Replacement

- To replace a thermocouple, ensure the appliance is completely cool.
- Shut off power to the appliance or unplug the control board from the junction box.
- Remove the dust cover by lifting up and pulling out to expose the control board.
- Remove the thermocouple wire that needs replacing from the control board by pulling up on it and feeding it back through the grommet. See Figure 4.5.

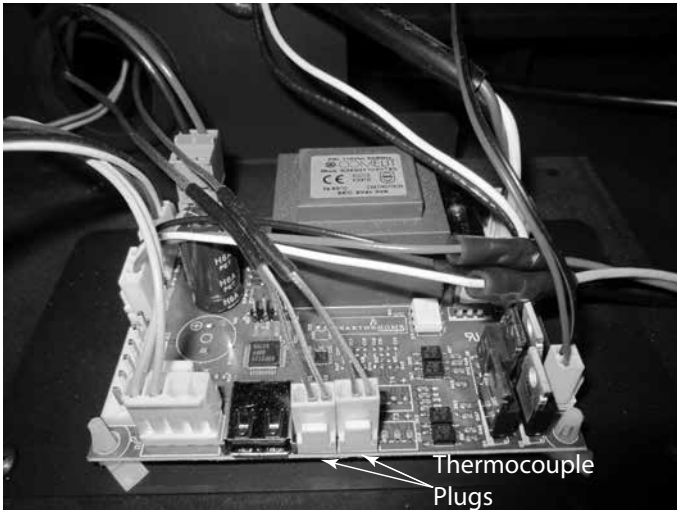

Figure 4.5 Control Board

- Next, open the appliance door, look for the thermocouple in the top left or top right side of the firebox. Once located, using a 3/16" Allen wrench, remove the (2) Allen bolts, then pull the cover plate (with the Thermocouple guard attached to it) down and off of the thermocouple. See Figure 4.6.

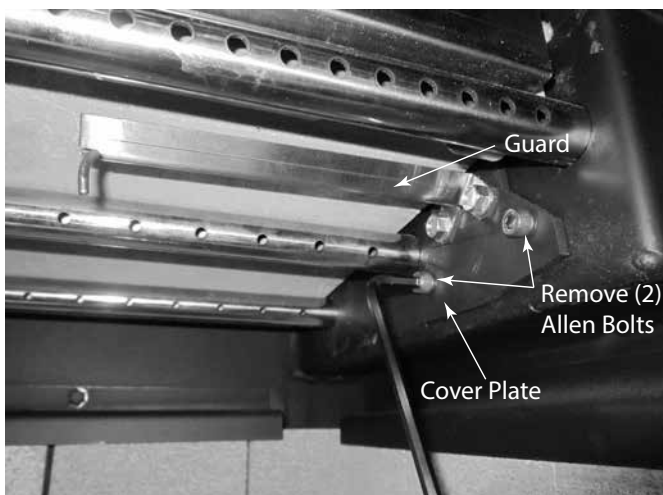

Figure 4.6 Cover Plate with Thermocouple Guard

- Using a long 3/8" nut driver, remove the (2) bolts in through the hole holding the thermocouple on. See Figure 4.7.

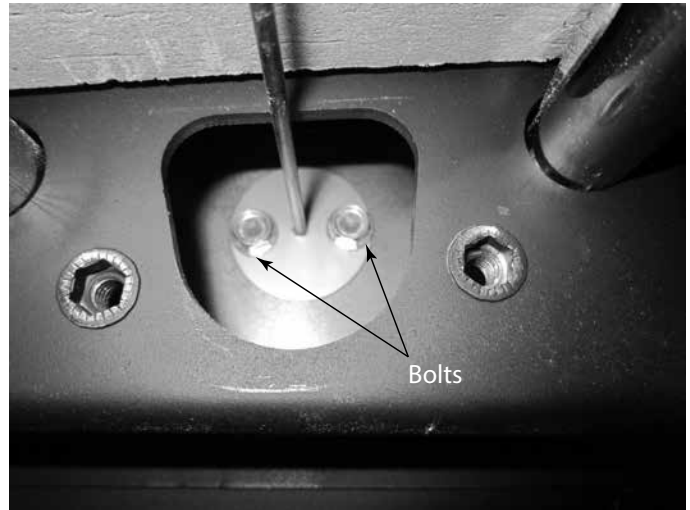

Figure 4.7 Remove Bolts (Access cover removed)

- Pull the thermocouple wire up and out of the hole while feeding the wire up from the bottom.
- Install the new thermocouple by feeding the end with the plug on it down through the hole and out through the bottom opening.
- Secure the thermocouple to the appliance and reinstall the cover plate with the thermocouple guard. Connect the wires to the control board and the dust cover.

7. Baffle Removal and Installation

WARNING! Hot Surfaces!

Glass and other surfaces are hot during operation AND cool down. **DO NOT** clean fireplace until it is cooled.

- Remove all ash from firebox and place into a metal container.
- Remove the baffle protection channel by lifting it up and turning it down and pulling it out of the firebox. See Figure 4.8.



Figure 4.8 Removing Baffle Protection Channel



Figure 4.9 Baffle Board Locations

- The baffle board is in two pieces. Pull one piece at a time forward, tilting it down and out. See Figure 4.9.
- Remove the other piece the same way.
- If replacing the ceramic blanket, pull it forward/down and out.
- Reinstall the ceramic blanket up and over the manifold tubes, making sure it is laying flat and pushed back.
- Reinstall the baffle boards and the baffle protection channel. See Figures 4.10 and 4.11.

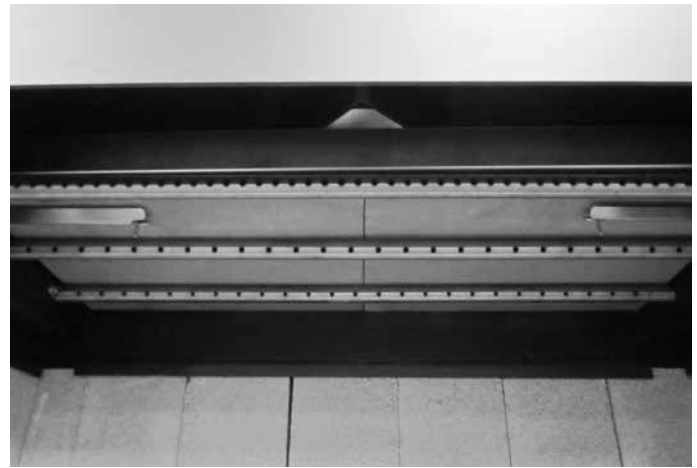

Figure 4.10 Reinstall Baffle Boards

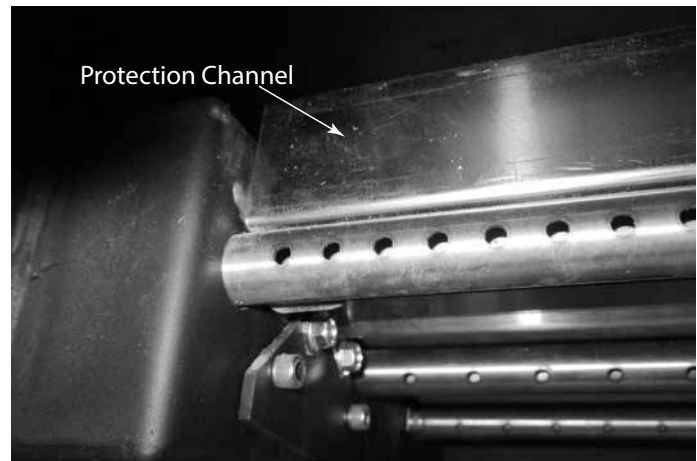

Figure 4.11 Reinstall Baffle Protection Channel

8. Fan Replacement

CAUTION! Risk of Shock! Disconnect power by turning off circuit breaker before servicing or unplugging control board from junction box in behind the access panel..

The Fireplace comes equipped with two fans, installed at the factory with electric access on both sides of the fireplace.

• Fan Replacement Instructions



Figure 4.12 Fan Locations

- Open the bottom access panel and remove it by pulling out on one of the spring hinges.
- Lift the control cover up and out to expose the control board. See Figure 4.13.



Figure 4.13 Remove Control Cover

- Unplug the thermocouple wires from the control board. See Figure 4.14.

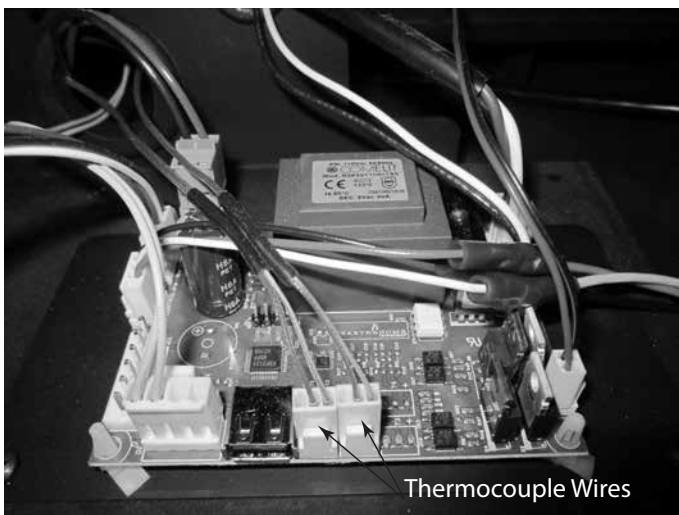

Figure 4.14 Unplug Thermocouple Wires

- Remove the (4) screws from each fan access panel and pull them forward and out. See Figure 4.15.

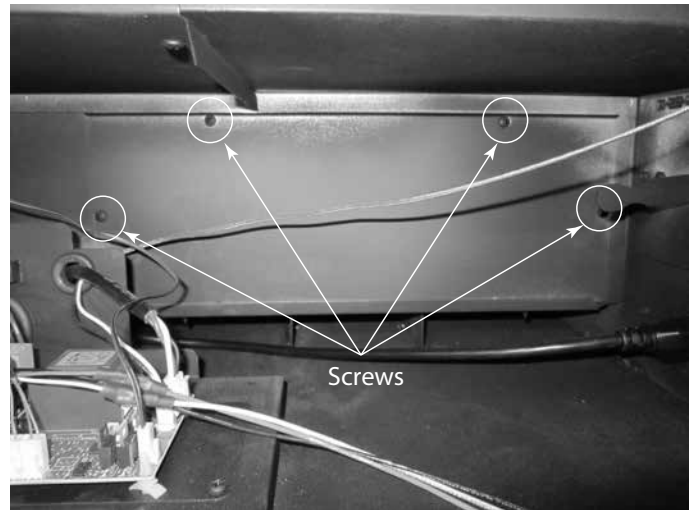

Figure 4.15 Remove Screws From Access Panel

- Disconnect the wires from the fans. See Figure 4.16.

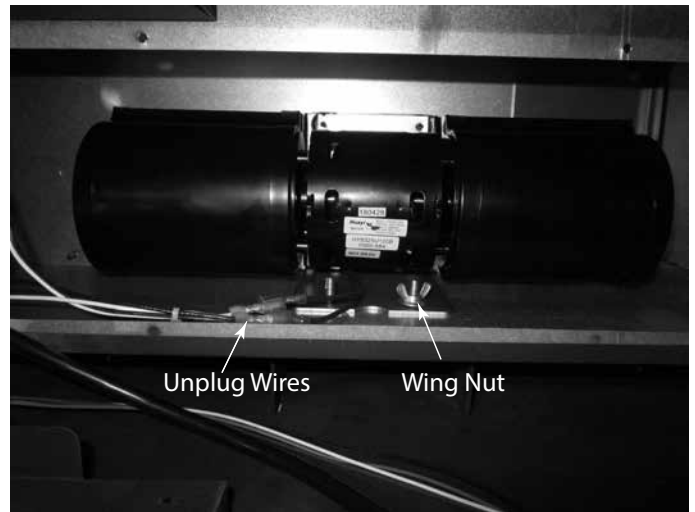

Figure 4.16 Disconnect Wires from Fans

- Remove the wing nuts that lock the fans down.
- Lift the fans up to clear the bolts and fish them around and out the front.
- Reinstall in the reverse order.

5 Troubleshooting

A. FAQs

Hearth & Home Technologies assumes no responsibility for the improper performance of the fireplace system caused by inadequate draft due to environmental conditions, down drafts, tight sealing construction of the structure, or mechanical exhausting devices which will create a negative air pressure within the structure where the fireplace is located.

If smoke spillage occurs from a fireplace opening when the door is open, there is either a leakage in the flue, a blockage in the flue, or some condition is affecting draft. Understanding and differentiating the conditions which can cause each of these kinds of spillage problems is essential to their solution.

- **Flue Leakage**
Check for improperly connected flue joints or a damaged flue joint in the chimney system. Such leakage would reduce draft (air would be drawn in through the leaks rather than through the fireplace). The result might be difficult start-up and smoky fires that might spill if other adverse draft conditions accompany this problem.
- **Flue Blockage**
The damper should be open.
Check for objects that may have fallen down the chimney.

Flue draft is measured as negative pressure in the chimney. The amount of negative pressure determines how strong the draft is. The draft is important because it draws the combustion air into the fireplace and pulls the smoke out of the chimney.

There are three basic criteria essential in establishing and maintaining flue draft:

- availability of combustion air
- heat generated from the fire
- diameter and height of the flue system

These three factors work together as a system to create the flue draft. Increasing or decreasing any one of them will affect the other two and thus change the amount of draft in the entire system.

If the fire is hard to start and smoke spills out of the fireplace, or you find it difficult to establish and maintain a moderately high burn rate, then the flue draft is too low and corrective measures must be taken.

Be sure you have air available for combustion and that your firewood is dry and well seasoned. Build your fires properly and according to the instructions given in op-

erating instructions, "Starting a Fire". Be sure your flue system is installed correctly and that it is the proper diameter and height. Check for the following:

- All chimney sections are properly installed.
- The chimney is clean and free of creosote or soot buildup.
- Make sure overhanging trees and branches are cut back within ten feet of the top of the chimney and the chimney is free of debris from animals.
- Ensure the chimney cap is clean and free of any buildup of soot or creosote if cap is equipped with a spark arrestor screen.
- Be sure the ceramic blanket (above the baffle) and the baffle are in their proper positions
- The wood being used is dry and well seasoned.

If you still suspect you have a low draft problem it may be necessary to increase the volume of air in your flue system. Since the diameter of your flue system is matched with the size of the flue collar and should not be changed, then the height of the system must be increased. Add chimney sections one at a time until the draft improves.

In some cases, regardless of what you do, it can still be difficult to establish the proper flue draft. This is especially evident when using an exterior factory-built chimney or exterior masonry chimney. Try holding a burning rolled up newspaper as close to the flue outlet as possible for a few minutes, then light the paper under the kindling. The heat generated from the burning rolled up newspaper should help get the draft established.

Still other factors can affect how well your flue system performs. Neighboring structures, high winds, tall trees, even hillsides can affect air currents around the chimney. Well designed chimney caps are available that can help. Your fireplace dealer is the local expert in your area. He can usually make suggestions or discover problems that can be easily corrected allowing your fireplace to operate correctly as it has been designed, providing safe and economical heat for your home.

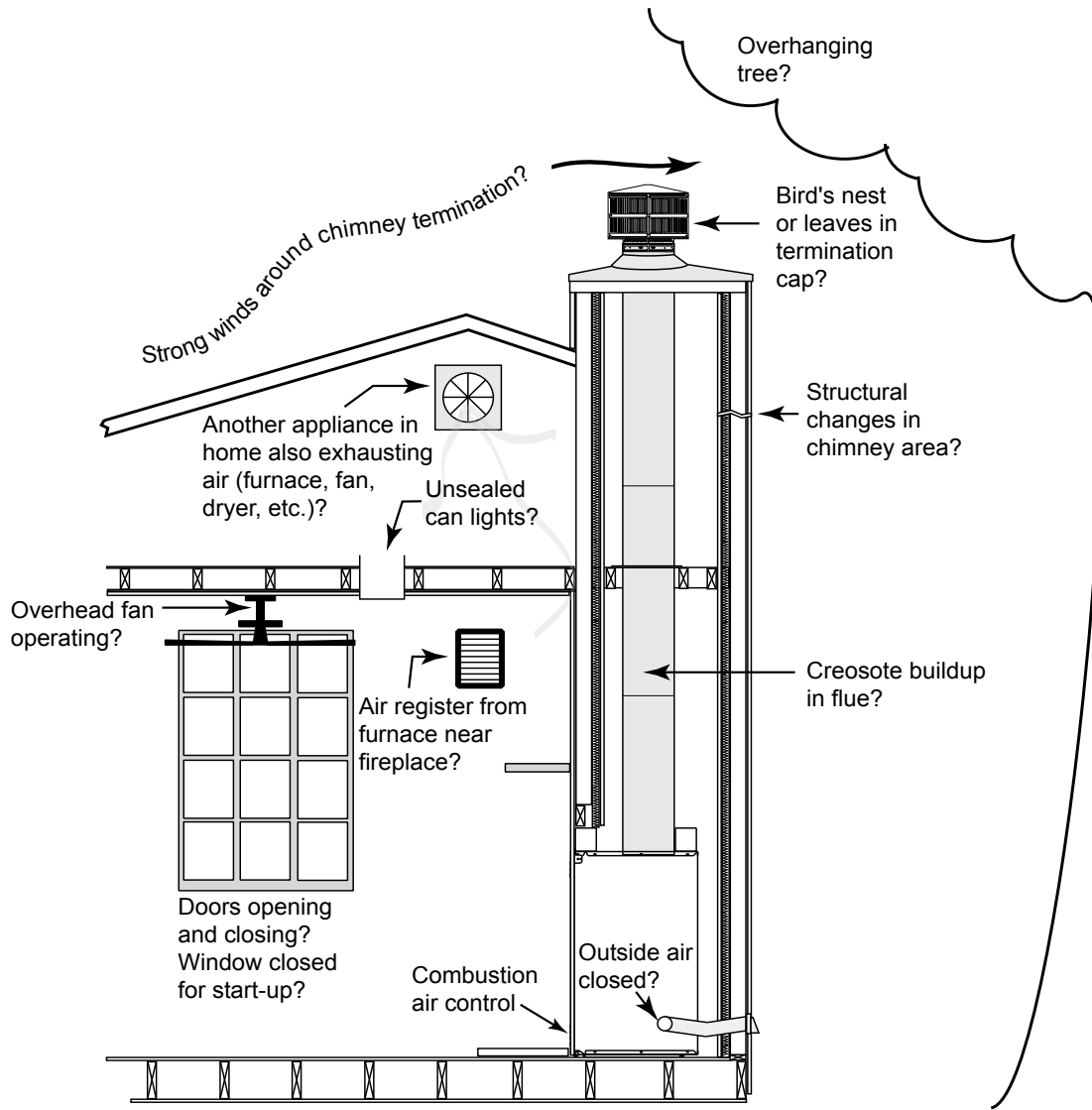

Figure 5.1 Factory-built Fireplaces: Troubleshooting

B. Troubleshooting Table

With proper installation, operation, and maintenance your wood burning appliance will provide years of trouble-free service. If you do experience a problem, this troubleshooting guide will assist you or a qualified service person in the diagnosis of a problem and the corrective action to be taken.

Start Fire Problems	Possible Cause	Solution
Can not get fire started Excessive smoke or spillage Burns too slowly Not enough heat output	Not enough kindling/paper or no kindling/paper	Use dry kindling, more paper. Arrange kindling & wood for air movement.
	Not enough air for fire to ignite	Check for restricted termination cap
		Check for blockage of outside air kit (if installed).
		Check for flue blockage.
		Pre-warm flue before starting fire (refer to Building a Fire Section).
		Check for adequate vent height.
		Open window below the appliance towards the wind.
	Wood condition is too wet, too large	Use dry, seasoned wood (refer to Seasoned Wood Section).
	Bed of coals not established before adding wood	Start with paper & kindling to establish bed of coals (refer to Building a Fire Section).
	Flue blockage such as birds' nests or leaves in termination cap	Have chimney and cap inspected and cleaned by a certified chimney sweep.
	Down draft or negative pressure Competition with exhaust devices	Do not use exhaust fans during start-up.
		Open window below the appliance towards the wind.
	Activation button not pressed when starting fire	Press activation button and ensure that the indicator light turns solid green.
	Actuator on air control did not move to full open position	In all cases the air control will move to the full open position after pressing the activation button. A visual check of this may be in order or follow the field diagnostics guide.
	Blinking red light indicated on activation button	This is indicating a fault of a component in the appliance. Refer to the diagnostics guide to analyze the blinking and to diagnose further. Do not operate appliance.
No AC power to appliance	Check breaker box and ensure both ends of the power cord are plugged in underneath.	
Low Batteries or NO batteries placed in battery backup appliance	Low voltage of the battery pack or lack of batteries in the backup battery pack will not allow operation of system if regular AC power is not available. Replace batteries.	
Air control disconnected from actuator due to previous disconnecting	If the air control was disconnected due to no regular AC power/ no batteries or low battery voltage condition then it will be necessary to reattach the air control to the actuator.	

Troubleshooting Guide con't

Fire burns too fast or room temperature is overshooting the set point of the thermostat	Extremely dry or soft wood	Mix in hardwood.
		Mix in less seasoned wood after fire is established (refer to Wood Fuel Section).
	Overdrafting	Check for correct vent height; too much vertical height creates overdrafting.
		Check location of vent termination (refer to Chimney Termination Requirement Section).
	Thermostat is not operational or is programed incorrectly.	Refer to specific instructions for thermostat used for proper programming method. Refer to field diagnostics to ensure that signal from thermostat is being interpreted by circuit board correctly.
	Too much fuel was loaded into appliance when reloaded.	Proper amounts of fuel must be loaded based on specific home conditions and exterior weather conditions.
	Air control is not closing to reduce burn rate.	This could be related to any of the conditions found above. Refer to the field diagnostics to perform some testing.
	Thermocouples in appliance are no longer in proper position.	The thermocouples that sense the condition of the fire in the appliance must be in the proper location. A hit from loading fuel or other event may have caused them to bend excessively. In a cool appliance they can be bent back into proper position.
Thermocouple failure.	This will be indicated by a blinking light on the activation button. Refer to diagnostics.	
Fan not operating properly	Fan not turning on when appliance is hot.	Check that the rotational position of the power level knob is on a selected power level rather than off.
		Check that the fan wire is plugged into the control board underneath.
		Check that the fan is plugged into the back of the appliance.
	Fan is running at maximum setting all the time.	This could indicate a failure of the thermocouples in the appliance. This condition will also be indicated by a blinking light on the activation button. Refer to diagnostics.
Glass doesn't stay clean	Burning on low, wet wood	Establish a good hot fire. Use well-seasoned wood.

Diagnostics

Indication	Item	Fault Implication while in use to homeowner
Green Light	Activation button has been pushed.	Appliance is ready for a new fire or reload.
No Light	Thermostat is not calling for heat	Appliance is in shutdown mode.
Red Light	Appliance call for heat	Appliance is in charcoal phase and thermostat calling for heat. Time to reload.
Two blinks flashes of red light then long off (1 sec)	Left Thermocouple burned out (open circuit)	Appliance will exhibit either late or premature shutdowns. Could lead to snuffing of the fire if shutdown too quickly or too much heat when commanded to shutdown.
Three fast blinks of red light then long off (1 sec)	Right Thermocouple burned out (open circuit)	Appliance will exhibit either late or premature shutdowns. Could lead to snuffing of the fire if shutdown too quickly or too much heat when commanded to shutdown.
.5 second on and .5 off of red light	Overfire Indication	The appliance air control is 'stuck' open if we are seeing temps over the safety limit for 30 minutes. Stuck due to a jammed air control or a faulty linear actuator. Not much the controller can do other than alert the homeowner with the status light because it may have happened while homeowner was away.

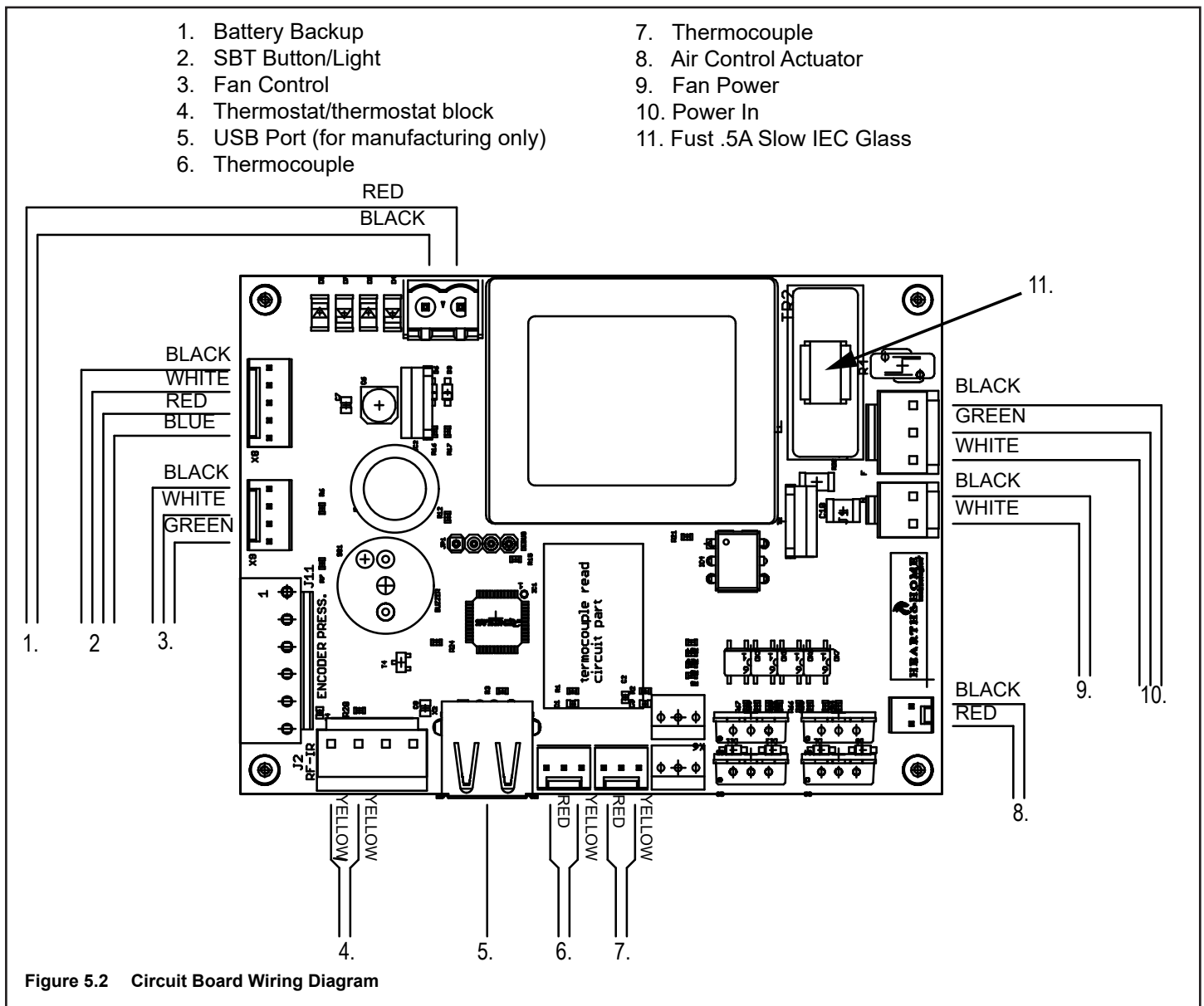

6 Reference Materials

A. Service Parts



Service Parts
Wood-burning Fireplace

PIONEER-III-BK

Beginning Manufacturing Date: May 2019
Ending Manufacturing Date: Active

PIONEER-III-ABK - Arch Door

PIONEER-III-RBK - Rectangle Door

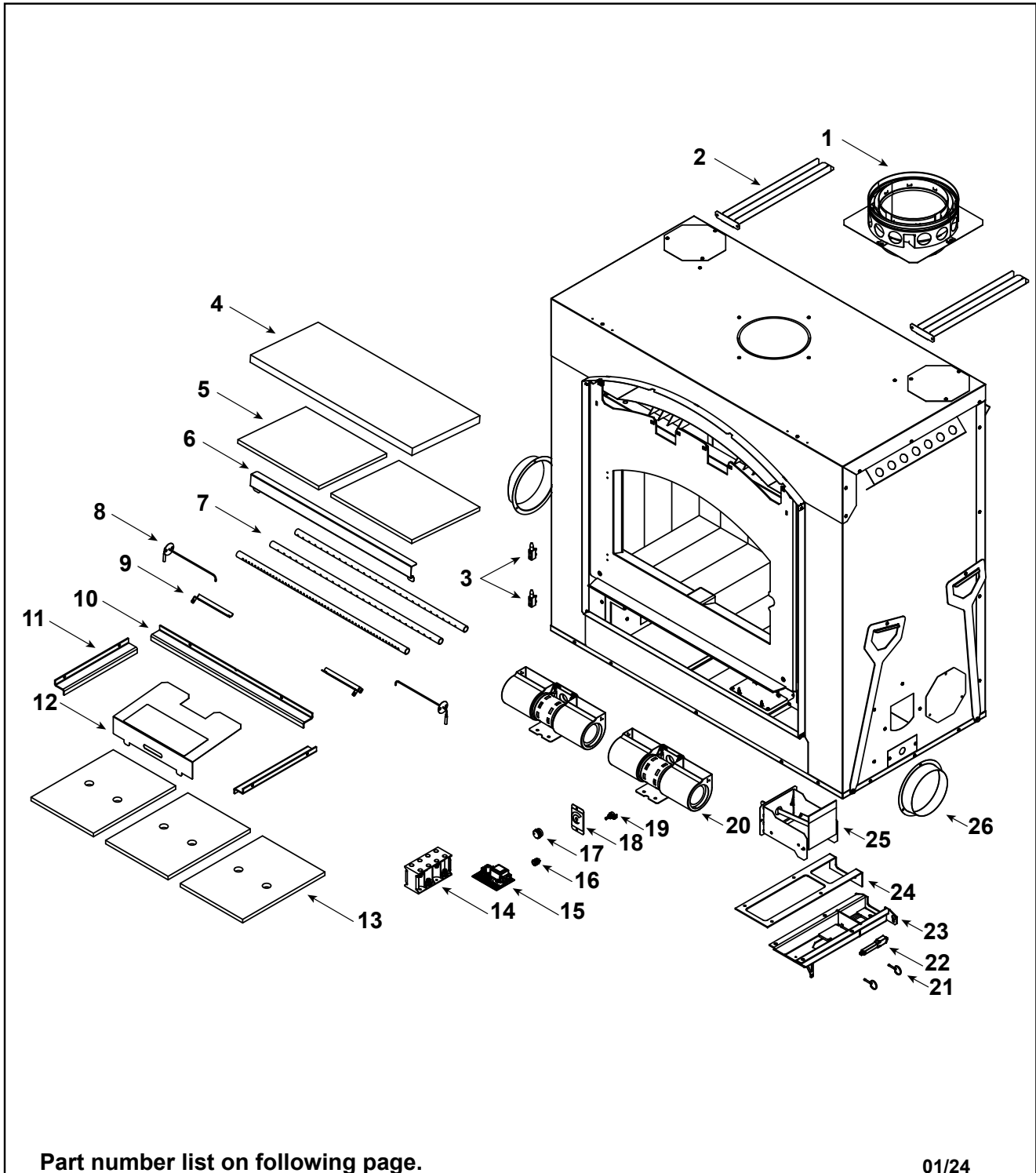

IMPORTANT: THIS IS DATED INFORMATION. Parts must be ordered from a dealer or distributor. **Hearth and Home Technologies does not sell directly to consumers.** Provide model number and serial number when requesting service parts from your dealer or distributor.



Stocked at Depot

ITEM	DESCRIPTION	COMMENTS	PART NUMBER	
1	Starter Plate Assembly		SL1	
	8 in Starter Section		SRV22069	Y
2	Standoff, Front	Qty 2 req	SRV4182-233	
3	Hinge, Male	Qty 2 req	SRV4181-302	
4	Baffle Blanket		SRV4182-205	
5	Baffle	Qty 2 req	SRV4182-113	
6	Baffle Protector		SRV4182-195	
7	Manifold Tube Set	Set of 3	TUBES-4182	Y
8	Thermocouple	Qty 2 req	SRV4083-147	
	Wire Harness, Thermostat		SRV4182-304	Y
9	Shield, Sensor	Qty 2 req	SRV4083-212	
10	Brick Retainer, Back		SRV4182-123	
11	Brick Retainer, Side	Qty 2 req	SRV4182-121	
12	Cover Assembly, Control Board		SRV4182-034	
13	Refractory Bottom	Qty 3 req	SRV4182-135	
14	Battery Back Up		SRV4083-177	Y
15	Control Board Assembly		SRV4182-050	Y
	Wire Harness, AC		SRV4182-176	Y
	Wire Harness, JBOX		SRV4182-311	Y
16	Push Button		SRV4182-134	Y
17	Knob Knurled Black		SRV4083-743	
18	Control Plate Assembly		SRV4083-035	
19	Fan Control		SRV4083-179	
20	Fan Assembly	Qty 2 req	SRV433-5890	Y
	Wire Harness, Fan AC		SRV4182-178	Y
21	Detent Pin, 5/32	Qty 2 req	SRV4083-376	
22	Linear Actuator		SRV4083-130	Y
23	Air Control Channel Assembly		SRV4182-012	
24	Gasket, Air Control Channel Assembly		SRV4182-189	
25	Outside Air Assembly		SRV4182-039	
26	Unit Collar	Qty 2 req	SRV4087-314	
	Non-Comb Board Assembly	PIONEER-III-ABK	SRV4182-064	
		PIONEER-III-RBK	SRV4183-064	
	Touch Up Paint	Black	812-0910	
	Programmable, Thermostat		PROG-STAT	Y
	Outside Air Hood Assembly		4059-051	

Additional service part numbers on following page.

IMPORTANT: THIS IS DATED INFORMATION. Parts must be ordered from a dealer or distributor. **Hearth and Home Technologies does not sell directly to consumers.** Provide model number and serial number when requesting service parts from your dealer or distributor.

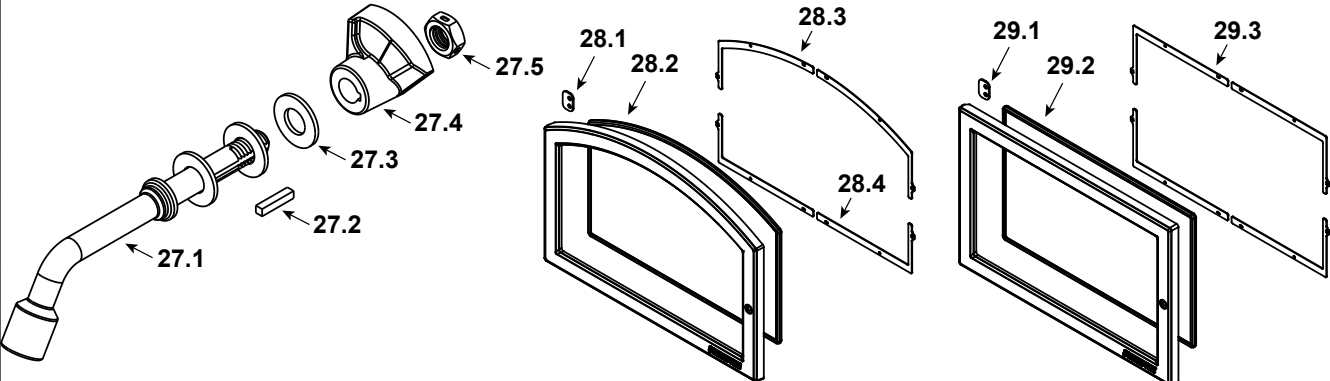

Stocked at Depot

ITEM	DESCRIPTION	COMMENTS	PART NUMBER	
#27 Door Assembly				
				
27	Door Handle Assembly		SRV4181-022	Y
27.1	Handle, Door		SRV4181-301	
27.2	Latch Cam Key		SRV430-1151	
27.3	Washer, 3/8 SAE	Pkg of 3	832-0990	Y
27.4	Door Latch Cam Mill		SRV430-1141	
27.5	Nut, 3/8 - 16 Prevailing Torque	Pkg of 24	226-0100/24	Y
	Fiber Handle		SRV433-1380	Y
28	Arch Door Assembly		SRV4182-030	
28.1	Hinge Retainer		SRV4181-122	
28.2	Glass Assembly		SRV4182-031	Y
	Rope, 1/2 Wire Jacket	10 Ft	7000-811/10	Y
28.3	Glass Retainer	Qty 2 req	SRV4182-241	
28.4	Glass Retainer	Qty 2 req	SRV4182-240	
	Screw, 8-32 x 3/8 PPH BK	Pkg of 40	225-0500/40	Y
29	Rectangle Door Assembly		SRV4183-030	
29.1	Hinge Retainer		SRV4181-122	
29.2	Glass Assembly		SRV4183-031	Y
	Rope, 1/2 Wire Jacket	10 Ft	7000-811/10	Y
29.3	Glass Retainer	Qty 4 req	SRV4183-240	
	Screw, 8-32 x 3/8 PPH BK	Pkg of 40	225-0500/40	Y

Additional service part numbers on following page.

IMPORTANT: THIS IS DATED INFORMATION. Parts must be ordered from a dealer or distributor. **Hearth and Home Technologies does not sell directly to consumers.** Provide model number and serial number when requesting service parts from your dealer or distributor.



Stocked at Depot

ITEM	DESCRIPTION	COMMENTS	PART NUMBER
------	-------------	----------	-------------

#30 Brick Assembly

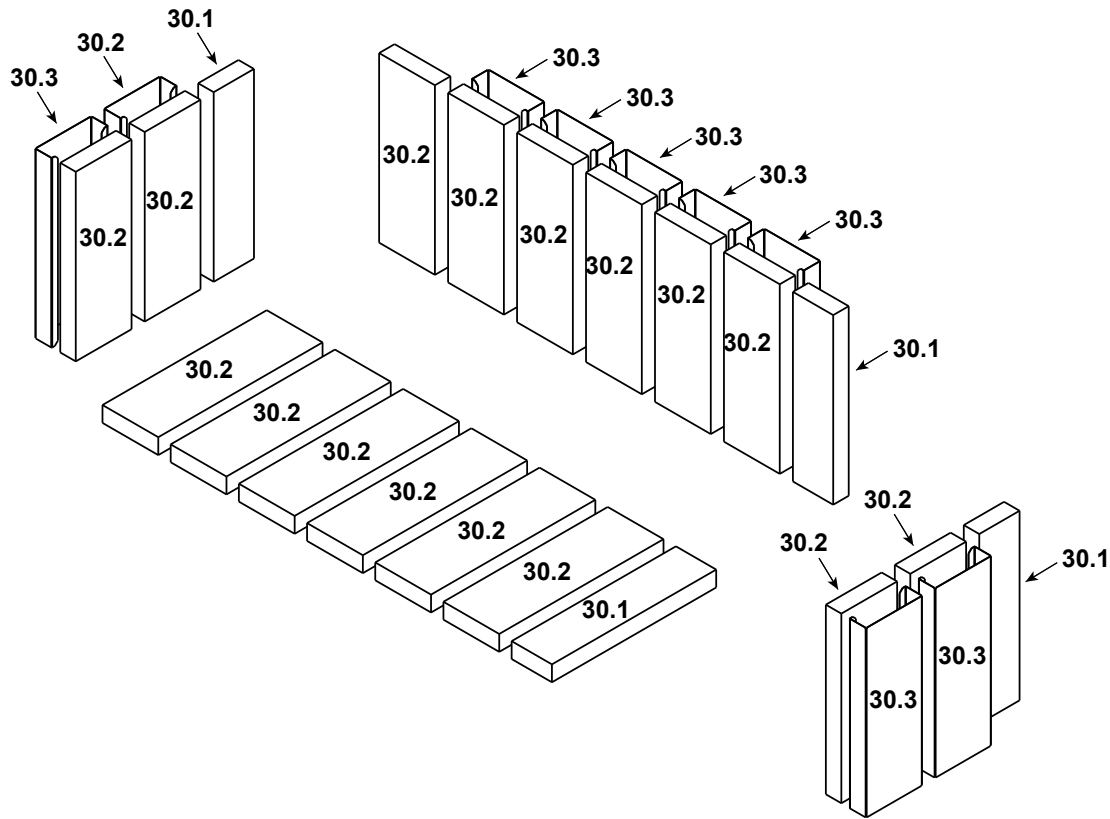

30	Brick Assembly		SRV4182-016	Y
30.1	Brick, 13 1/4 x 3 1/4 x 1 1/4	Qty 4 req	SRV4182-203	
30.2	Brick, 13 1/4 x 4 1/2 x 1 1/4	Qty 16 req	SRV4182-301	
30.3	Brick Wrap	Qty 9 req	SRV4182-101	
Fastener Packs				
	Nut, 3/8 - 16 Prevailing Torque	Pkg of 24	226-0100/24	Y
	Screw, 8-32 x 3/8 PPH BK	Pkg of 40	225-0500/40	Y
	Screw, 8 x 1/2 PPH BK	Pkg of 40	12460/40	Y
	Screw, HWH MS 1/4-20 x 3/4	Pkg of 25	220-0080/25	Y
	Washer, 3/8 SAE BK	Pkg of 3	832-0990	Y

This page intentionally left blank.

B. Contact Information



Hearth & Home Technologies
1915 West Saunders Street
Mount Pleasant, Iowa 52641

Please contact your dealer with any questions or concerns.

For the number of your nearest dealer, please visit www.fireplaces.com.

– NOTES –

CAUTION

DO NOT DISCARD THIS MANUAL



- Important operating and maintenance instructions included.

- Read, understand and follow these instructions for safe installation and operation.

- Leave this manual with party responsible for use and operation.



This product may be covered by one or more of the following patents: (United States) 6601579, 6769426, 6863064, 7077122, 7074035, 7098269, 7234932, 7258116, 7322819, 7422011, 7470729, 7726300, 8147240, 9625149 or other U.S. and foreign patents pending.

2000-945E