

MODEL / MODÈLE : PB0500SP, PB0820SP, PB1000SP, PB1100SP
PART / PIÈCE : 10532, 10534, 10535, 10537, 10564, 10565, 10566, 10567



SPORTSMAN

**OWNERS MANUAL
LE MANUEL DU PROPRIÉTAIRE**

WOOD PELLET GRILL & SMOKER

IMPORTANT, READ CAREFULLY, RETAIN FOR FUTURE REFERENCE. MANUAL MUST BE READ BEFORE OPERATING!

GRIL & FUMOIR À GRANULES DE BOIS

IMPORTANT, PRENEZ CONNAISSANCE DE CE DOCUMENT ET CONSERVEZ-LE POUR RÉFÉRENCE ULTÉRIEURE. VOUS DEVEZ LIRE CE GUIDE AVANT D'UTILISER LE BARBECUE!

For outdoor and household use only. Not for commercial use.
Réservé à l'usage extérieur et résidentiel uniquement. Non destiné à un usage commercial.

WARNING: Please read the entire manual before installation and use of this electric, pellet fuel-burning appliance. Failure to follow these instructions could result in property damage, bodily injury or even death. Contact local building or fire officials about restrictions and installation inspection requirements in your area.

AVERTISSEMENT : Veuillez lire l'intégralité du manuel avant l'installation et l'utilisation de cet appareil électronique à granules. Le non-respect de ces instructions peut entraîner des dommages aux biens, des blessures ou même la mort. Communiquez avec les autorités locales en matière d'incendie et de bâtiment concernant les restrictions et les exigences d'installation dans votre région.



OPERATING INSTRUCTIONS

With today's lifestyle of striving to eat healthy and nutritious foods, one factor to consider is the importance of reducing fat intake. One of the best ways to cut down on fat in your diet is to use a low fat method of cooking, such as grilling. As a pellet grill uses natural wood pellets, the savory wood flavor is cooked into the meats, reducing the need for high sugar content sauces. Throughout this manual, you will notice the emphasis on grilling food slowly at LOW or MEDIUM temperature settings.

GRILL ENVIRONMENT

1. *WHERE TO SET-UP THE GRILL*

With all outdoor appliances, outside weather conditions play a big part in the performance of your grill and the cooking time needed to perfect your meals. All Pit Boss® units should keep a minimum clearance of 305mm (12 inches) from combustible constructions and this clearance must be maintained while the grill is operational. This appliance must not be placed under an overhead combustible ceiling or overhang. Keep your grill in an area clear from combustible materials, gasoline and other flammable vapors and liquids.

2. *COLD WEATHER COOKING*

As it becomes cooler outside, that does not mean that grilling season is over! The crisp cool air and heavenly aroma of smoked foods will help cure your winter blues.

Follow these suggestions on how to enjoy your grill throughout the cooler months:

- If smoking at low temperatures fails, increase the temperature slightly to achieve the same results.
- Organize – Get everything you require ready in the kitchen before you head outdoors. During the winter, move your grill to an area that is out of the wind and direct cold. Check local bylaws regarding the proximity of your grill in relation to your home and/or other structures. Put everything you need on a tray, bundle up tight, and get it done!
- To help keep track of the outside temperature, place an outdoor thermometer close to your cooking area. Keep a log or history of what you cooked, the outdoor temperature, and the cooking time. This will help later down the road to help you determine what to cook and how long it will take.
- In very cold weather, increase your preheating time by at least 20 minutes.
- Avoid lifting the lid any more than necessary. Cold gusts of wind can completely cool your grill temperature. Be flexible with your serving time; add extra cooking time each time you open the lid.
- Have a heated platter or a dish cover ready to keep your food warm while making the trip back inside.
- Ideal foods for winter cooking are those that require little attention, such as roasts, whole chickens, ribs, and turkey. Make your meal preparation even easier by adding simple items such as vegetables and potatoes.

3. *HOT WEATHER COOKING*

As it becomes warmer outdoors, the cooking time will decrease. Proper dress is important when it gets really hot: shorts, shirt, shoes, hat, apron and a generous slab of suntan lotion is recommended.

Follow these few suggestions on how to enjoy your grill throughout the hot months:

- Adjust your cooking temperatures downward. This helps to avoid unwanted flare-ups.
- Use a meat thermometer to determine the internal temperature of your foods. This helps in preventing your meat from over cooking and drying out.
- Even in hot weather it is still better to cook with the lid of your grill down.
- You can keep foods hot by wrapping them in foil, and placing them in an insulated cooler. Stuff crumpled up newspaper around the foil and this will keep food hot for 3 to 4 hours.

GRILL TEMPERATURE RANGES

Temperature readouts on the control board may not exactly match the thermometer. All temperatures listed below are approximate and are affected by the following factors: outside ambient temperature, the amount and direction of wind, the quality of pellet fuel being used, the lid being opened, and the quantity of food being cooked.

- *HIGH TEMPERATURE (205-260°C / 401-500°F)*

This range is best used to sear and grill at a high heat. Use in tandem with the flame broiler (slide plate) for indirect or direct flame cooking. With the **flame broiler open**, direct flame is used to create those “blue” steaks, as well as flame-kissed vegetables, garlic toast or s’mores! When the **flame broiler is closed**, the air circulates around the barrel, resulting in convection heat. High temperature is also used to preheat your grill, burn-off the cooking grids, and to achieve high heat in extreme cold weather conditions.

- *MEDIUM TEMPERATURE (135-180°C / 275-356°F)*

This range is best for baking, roasting, and finishing off that slow smoked creation. Cooking at these temperatures will greatly reduce the chances of a grease flare-up. Ensure that the flame broiler slider is in the closed position, covering the slotted openings. Great range for cooking anything wrapped in bacon, or where you want versatility with control.

- *LOW TEMPERATURE (80-125°C / 176-257°F)*

This range is used to slow roast, increase smoky flavor, and to keep foods warm. Infuse more smoke flavor and keep your meats juicy by cooking longer at a lower temperature (also known as **low and slow**). Recommended for the big turkey at Thanksgiving, juicy ham at Easter, or the huge holiday feast.

Smoking is a variation on true barbecuing and is truly the main advantage of grilling on a wood pellet grill. **Hot smoking**, another name for **low and slow** cooking, is generally done between 80-125°C / 176-257°F. Hot smoking works best when longer cooking time is required, such as large cuts of meats, fish, or poultry.

TIP: To intensify that savory flavor, switch to SMOKE (low) temperature range immediately after putting your food on the grill. This allows the smoke to penetrate the meats.

The key is to experiment with the length of time you allow for smoking, before the meal is finished cooking. Some outdoor chefs prefer to smoke at the end of a cook, allowing the food to keep warm until ready to serve. Practice makes perfect!

UNDERSTANDING THE PROBES

- *TEMPERATURE PROBE*

Located inside the main barrel, on the left wall, is the temperature probe. It is a small, vertical piece of stainless steel. The temperature probe measures the internal temperature of the unit. When the temperature is adjusted on the Control Board, the temperature probe will read the actual temperature inside the unit and adjust to the desired temperature.

IMPORTANT: The temperature of your unit is highly affected by ambient outdoor weather, quality of pellets used, flavor of pellets, and the quantity of food being cooked.







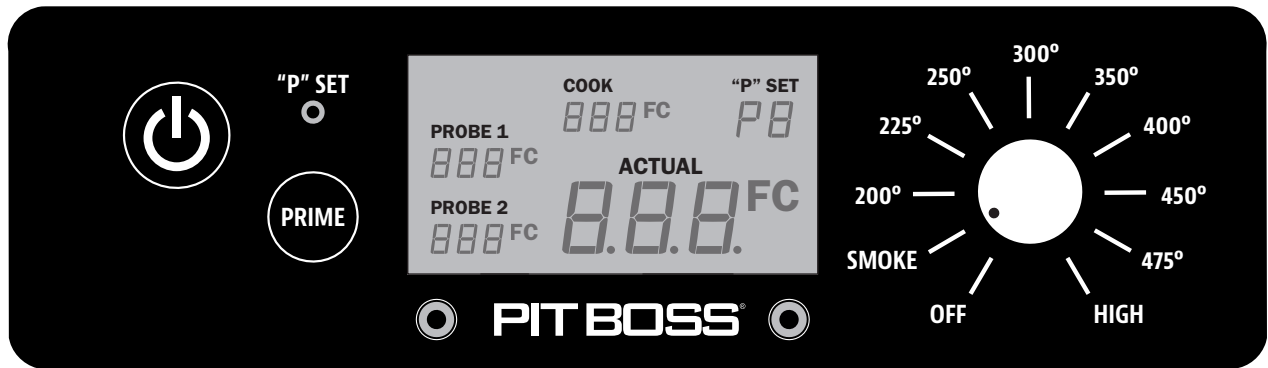

- *MEAT PROBE*

The meat probe measures the internal temperature of your meat in the grill, similar to your indoor oven. Plug-in the meat probe adapter to the meat probe connection port on the Control Board and insert the stainless steel meat probe into the thickest portion of your meat and the temperature will be displayed on the control board. **To ensure the meat probe is connected properly to the connection port, feel and hear it snap into place.**

NOTE: When placing the meat probe into your meat, ensure the meat probe and meat probe wires avoid direct contact with flame or excess heat. This can result in damage to your meat probe. Run the excess wire out the rear exhaust holes of the main grill or the top of the main grill (near the grill lid hinge). When not in use, disconnect from the meat probe connection port and place aside to keep protected and clean.

UNDERSTANDING THE CONTROL BOARD



CONTROL	DESCRIPTION
	Press the Power Button to power on the unit. The button will glow blue if connected to a power source. Press the button again to turn the unit off.
	The Temperature Control Dial allows you to set your desired smoking temperature. Once connected to a power source and the Power Button is pressed, turn the dial and select from any of the ten preset temperatures, between 82-260°C / 180-500°F. When the dial is turned to a temperature preset, the Digital LCD Screen will light up, displaying that it is ready to operate. When the dial is turned to off, the Digital LCD Screen will remain off.
"P" SET 	<p>The "P" Set Button is used to select one of the eight fine tunings when the Temperature Control Dial is set to the Smoke Setting. Press the button to change the "P" setting to accommodate to your cooking style and cooking environment, as preferred. With a <u>short push</u> of the button, the setting increases from P0 to P7, then repeats. Adjustments are only possible in the Smoke Setting. Factory default setting is "P4". If the "P" setting is adjusted, your preference will be locked-in (saved) until further adjustment is made.</p> <p>The "P" Set Button is also used as a Temperature Switch Control to change the temperature readout on the LCD Screen. Press and hold the button for two seconds to switch to Celsius (°C) or to Fahrenheit (°F), as preferred. Default is set to Fahrenheit.</p>
	The LCD Screen is used as the information center for your unit. The LCD screen will display your Desired Cook Temperature, Actual Cook Temperature, and Meat Probe Temperatures (if connected). If only one Meat Probe is connected, only one reading will be displayed.
PRIME 	Press and hold the Prime Button to activate an extra feed of pellets to the fire pot. This can be used to add more fuel to the fire before opening the barrel lid, resulting in a quick heat recovery time. It can also be used while smoking, to increase the intensity of clean smoke flavor. Requested from competition cookers.
SMOKE 	The Smoke Setting on the Temperature Control Dial is the start-up mode for the unit. The grill operates at the lowest temperature, without the fire going out.
	The plug-in connection port(s) on the front of the Control Board are for a Meat Probe(s) . When a meat probe is connected, the temperature is displayed on the LCD Screen. When not in use, disconnect the meat probe from the connection port. <i>Compatible with Pit Boss® branded meat probes only. Additional meat probe(s) sold separately.</i> 

UNDERSTANDING THE "P" SETTING

When the recessed "P" SET button is pushed, the "P" setting displayed on the LCD screen will flash and change to the next value (upward). Once P7 is reached, it will restart at P0. There are eight "P" settings, ranging from P0 to P7. The recessed "P" SET button can be pushed using a thin-tipped object.

IMPORTANT: Do not push the "P" SET button too hard, as this may cause damage. Only a light push is needed.

· USING THE "P" SETTING IN SMOKE MODE

Anytime the temperature dial is set to SMOKE, such as the start-up cycle, the auger will run on more of a manual mode of cooking versus using one of the preset dial temperatures. First, the auger will continuously turn and feed pellets for four minutes. After four minutes, the auger begins to run a feed cycle based on the "P" setting selected on the Digital Control Board. The default setting is P4.

"P" SET	AUGER CYCLE (seconds)	
	ON	OFF
P0	18	55
P1	18	70
P2	18	85
P3	18	100
*P4	18	115
P5	18	130
P6	18	140
P7	18	150

* default setting

HOPPER PRIMING PROCEDURE

These instructions should be followed the first time the grill is ignited, and each time the grill runs out of pellets in the hopper. The auger must be primed to allow pellets to travel through the length of the auger, and fill the fire pot. **If not primed, the igniter will timeout before the pellets are ignited, and no fire will start.** Follow these steps to prime the hopper:

1. Open the hopper lid. Make sure there are no foreign objects in the hopper or blocking the auger feed system at the bottom.
2. Remove all cooking components from the interior of the grill. Locate the fire pot in the bottom of the main barrel.
3. Plug the power cord into a power source. Press the **Power Button** to turn the unit on, and turn the **Temperature Control Dial** to the SMOKE position. Check the following items:
 - That you can hear the auger turning. Place your hand above the fire pot and feel for air movement. Do not place your hand or fingers inside the fire pot. This can cause injury.
 - After approximately a minute, you should smell the igniter burning and begin to feel the air getting warmer in the fire pot. The igniter tip does not glow red, but gets extremely hot and will burn. Do not touch the igniter.
4. Once verified that all electric components are working correctly, press the **Power Button** to turn the unit off.
5. Fill the hopper with all natural barbecue wood pellets.
6. Press the **Power Button** to turn the unit on. Keep the **Temperature Control Dial** in the SMOKE position. Press and hold the **Prime Button** until you see pellets on the inside of the grill from the auger tube. Once pellets begin to drop into the fire pot, release the **Prime Button**.
7. Press the **Power Button** to turn the unit off.
8. Re-install the cooking components into the main barrel. The grill is now ready to use. (See *Assembly Instructions* to ensure proper installation of cooking components.)

FIRST USE – GRILL BURN-OFF

Once your hopper has been primed and before cooking on your grill for the first time, it is important to complete a grill burn-off. Start the grill and operate at any temperature over 176°C / 350°F (with the lid down) for 30 to 40 minutes to burn-off the grill and rid it of any foreign matter.

AUTOMATIC START-UP PROCEDURE

1. Plug the power cord into a grounded power source. Open the main barrel lid. Check the fire pot to ensure there is no obstruction for proper ignition. Open the hopper lid. Ensure there are no foreign objects in the hopper or auger feed system. Fill the hopper with dry, all natural barbecue hardwood pellets.
2. Ensure the **Temperature Control Dial** is in the SMOKE position. Press the **Power Button** to turn the unit on. This will activate the start-up cycle. The auger feed system will begin to turn, the igniter will begin to glow and the fan will supply air to the fire pot. The grill will begin to produce smoke while the start-up cycle is taking place. The barrel lid must remain open during the start-up cycle. To confirm the start-up cycle has begun properly, listen for a torchy roar, and notice some heat being produced.
3. Once the heavy, white smoke has dissipated, the start-up cycle is complete and you are ready to enjoy your grill at your desired temperature!

IGNITER FAILURE PROCEDURE

If for any reason your electric igniter fails or your grill's flame dies out during a cook, check the following steps, or start your grill using the manual method.

1. Ensure the **Temperature Control Dial** is off and in the SMOKE position. Open the barrel lid. Remove the cooking components from inside. Remove all unburnt pellets and ash from the fire pot. Avoid touching the igniter to avoid injury, as it may be extremely hot.
2. Once all cooking components are removed and cleaned, press the **Power Button** to turn the unit on. Check the following:
 - Visually confirm that the igniter is working by placing your hand above the fire pot and feeling for heat.
 - Visually confirm that the igniter is protruding approximately 13mm / 0.5 inches in the fire pot.
 - Visually confirm that the auger is dropping pellets into the fire pot.
 - Confirm that the combustion fan is working by listening for a torchy roar.
3. If any of the above points are not working, follow **Troubleshooting** instructions.

MANUAL START-UP PROCEDURE

1. Ensure the **Temperature Control Dial** is in the SMOKE position. Plug the power cord into a grounded power source.
2. Check fire pot to ensure there is no obstruction for proper ignition. Open the hopper lid. Ensure there are no foreign objects in the hopper or auger feed system. Fill hopper with dry, all natural hardwood barbecue pellets.
3. Open the barrel lid. Remove the cooking components to expose the fire pot. Place a generous handful of pellets into the fire pot. Squirt a gelled fire starter, or other appropriate pellet starter, over the top of the pellets. A small amount of solid fuel fire starter, such as one composed of sawdust and wax, or wood shavings, is also appropriate. Add another small amount of pellets in the fire pot.

NOTE: Do not use spirit, petrol, gasoline, lighter-fluid or kerosene for lighting or refreshing a fire in your grill.

4. Light the contents of the fire pot using a long match or long-nosed lighter. Allow the starter to burn for 3 to 5 minutes. Do not attempt to add more starter into the fire pot. This can cause injury.
5. Quickly and carefully replace the cooking components to the inside of the main barrel. Continue start-up at step two of **Automatic Start-Up Procedure**.

SHUTTING OFF YOUR GRILL

1. When finished cooking, with the main barrel lid remaining closed, press the **Power Button** to turn the unit off and turn the **Temperature Control Dial** to OFF.

CARE AND MAINTENANCE

Any Pit Boss® unit will give you many years of flavorful service with minimum cleaning. An important step is allowing the grill and cooking grids to self-clean by running the grill at a high temperature for 5 to 10 minutes after each use. Follow these cleaning and maintenance tips to service your grill:

1. HOPPER ASSEMBLY

- The hopper includes a clean-out feature to allow for ease of cleaning and change out of pellet fuel flavors. To empty, locate the plate and the cover of the drop chute on the back side of the hopper. Place a clean, empty pail under the drop chute cover, then remove the cover piece. Unscrew the plate, slide outwards, and pellets will empty.

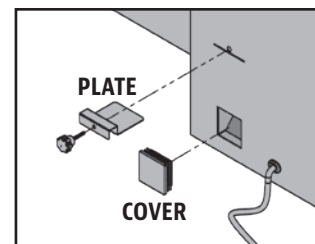

NOTE: Use a long handled brush or shop-vac to remove excess pellets, sawdust, and debris for a complete clean-out through the hopper screen.

- Check and clean off any debris from the fan air intake vent, found on the bottom of the hopper. Once the hopper access panel is removed (see *Electric Wire Diagram* for diagram), carefully wipe off any grease build-up directly on the fan blades. This ensures airflow is sufficient to the feed system.

2. PROBES

- Kinks or folds in the probe wires may cause damage to the part. Wires should be rolled up in a large, loose coil.
- Although the probes are stainless steel, do not place in the dishwasher or submerge in water. Water damage to the internal wires will cause the probe to short-out, causing false readings. If a probe is damaged, it should be replaced.

3. INSIDE SURFACES

- It is recommended to clean your fire pot after every few uses. This will ensure proper ignition and avoid any hard build-up of debris or ash in the fire pot.
- Use a long-handled grill cleaning brush, remove any food or build-up from the cooking grids. Best practice is to do this while they are still warm from a previous cook. Grease fires are caused by too much fallen debris on the cooking components of the grill. Clean the inside of your grill on a consistent basis. In the event you experience a grease fire, keep the grill lid closed to choke out the fire. If the fire does not go out quickly, carefully remove the food, turn the grill off, and shut the lid until the fire is completely out. Lightly sprinkle baking soda, if available.
- Check your grease bucket or tray often, and clean out as necessary. Keep in mind the type of cooking you do.

IMPORTANT: Due to high heat, do not cover the flame broiler or probes with aluminum foil.

4. OUTSIDE SURFACES

- Wipe your grill down after each use. Use warm soapy water to cut the grease. Do not use oven cleaner, abrasive cleansers or abrasive cleaning pads on the outside grill surfaces. **All painted surfaces are not covered under warranty, but rather are part of general maintenance and upkeep.** For paint scratches, wearing, or flaking of the finish, all painted surfaces can be touched up using high heat BBQ paint.
- Use a grill cover to protect your grill for complete protection! A cover is your best protection against weather and outside pollutants. When not in use or for longterm storage, keep the unit under a cover in a garage or shed.

CLEANING FREQUENCY TIME TABLE (NORMAL USE)

ITEM	CLEANING FREQUENCY	CLEANING METHOD
Bottom of Main Grill	Every 5-6 Grill Sessions	Scoop Out, Shop-Vac Excess Debris
Fire Pot	Every 2-3 Grill Sessions	Scoop Out, Shop-Vac Excess Debris
Cooking Grids	After Each Grill Session	Burn Off Excess, Brass Wire Brush
Flame Broiler	Every 5-6 Grill Sessions	Scrape Main Plate with Slider, Do Not Wash Clean
Front Shelf	After Each Grill Session	Scrub Pad & Soapy Water

Grease Bucket / Tray	After Each Grill Session	Scrub Pad & Soapy Water
Auger Feed System	When Pellet Bag is Empty	Allow Auger to Push Out Sawdust, Leaving Hopper Empty
Hopper Electric Components	Once A Year	Dust Out Interior, Wipe Fan Blades with Soapy Water
Air Intake Vent	Every 5-6 Grill Sessions	Dust, Scrub Pad & Soapy Water
Meat Probe	After Each Grill Session	Scrub Pad & Soapy Water
Temperature Probe	Every 2-3 Grill Sessions	Scrub Pad & Soapy Water

USING WOOD PELLET FUEL

These clean-burning barbecue wood pellets generate about 8200 BTU's per pound with very little ash, a low moisture content (5-7%), and are carbon neutral. Barbecue wood pellets are produced by pure raw material (sawdust) being pulverized with a hammer-mill, and the material is pushed through a die with pressure. As the pellet is forced through the die, it is cut, cooled, screened, vacuumed, and then bagged for consumer use. Check with your local dealer for flavors available in your area.

HICKORY BLEND 
 Rich, smoky bacon-like flavor. Considered the "Kings of the Woods".

MESQUITE BLEND 
 Strong, tangy, spicy flavor. Think Tex-Mex cuisine.

APPLE BLEND 
 Smoky, mild sweetness flavor. Highly recommended for baking.

MAPLE BLEND 
 Sweet and savory flavor.

ALDER BLEND 
 Sweet and earthy flavor. Alder, Maple and Pine Blend.

FRUITWOOD BLEND 
 Cherry, Apple and Maple Blend.

CHERRY BLEND 
 Slightly sweet, but also tart. Gives a rosy tint to light meals.

WHISKEY BARREL BLEND 
 Strong, sweet smoke with aromatic tang. Perfect for red meats.

COMPETITION BLEND 
 Perfect blend of sweet, savory, and tart. Used by many professional grillers.

PECAN BLEND 
 Bold, buttery and smooth flavor.

OAK BLEND 
 Rich and smokey flavor.

CLASSIC BLEND 
 Pecan, Hickory and Mesquite Blend.

NOTE: Always store wood pellets in a dry area. Avoid any contact or exposure to moisture will result in lower heat output or cause the pellets to swell and break apart. Use a moisture proof, resealable tub or bucket for proper storage.

TROUBLESHOOTING

Proper cleaning, maintenance and the use of clean, dry, quality fuel will prevent common operational problems. When your Pit Boss® grill is operating poorly, or on a less frequent basis, the following troubleshooting tips may be helpful. For FAQ, please visit www.pitboss-grills.com. You may also contact your local Pit Boss® authorized dealer or contact Customer Service for assistance.

WARNING: Always disconnect the electrical cord prior to opening the grill for any inspection, cleaning, maintenance or service work. Ensure the grill is completely cooled to avoid injury.

ENGLISH

PROBLEM	CAUSE	SOLUTION
No Power Lights On The Control Board	Temperature Control Dial is still off.	Press the Power Button, and ensure the button glows blue to show there is a power connection. Turn the Temperature Control Dial to a temperature setting.
	Not Connected To Power Source	Ensure unit is plugged into a working power source. Reset breaker. Ensure GFCI is a minimum 10 Amp service (see Electric Wire Diagram for access to electric components) Ensure all wire connections are firmly connected and dry.
	Fuse Blown On The Control Board	Remove hopper access panel (see Electric Wire Diagram for diagram), press in plastic tabs holding the control board in place and carefully pull controller inside the hopper to release controller. Check the fuse for a broken wire or if the wire has turned black. If yes, fuse needs to be manually replaced.
	The GFCI outlet has been tripped.	Ensure GFCI is a minimum 10 Amp service.
	Faulty Control Board	Control Board needs to be replaced. Contact Customer Service for a replacement part.
Fire in Fire pot Will Not Light	Auger Not Primed	Before the unit is used for the first time <u>or</u> anytime the hopper is completely emptied out, the auger must be primed to allow pellets to fill the auger tube. If not primed, the igniter will timeout before the pellets reach the fire pot. Follow Hopper Priming Procedure .
	Auger Motor Is Jammed	Remove cooking components from the main barrel. Press the Power Button to turn the unit on, turn Temperature Control Dial to SMOKE, and inspect the auger feed system. Visually confirm that the auger is dropping pellets into the fire pot. If not operating properly, call Customer Service for assistance.
	Igniter Failure	Remove cooking components from the main barrel. Press the Power Button to turn the unit on, turn Temperature Control Dial to SMOKE, and inspect the igniter. Visually confirm that the igniter is working by placing your hand above the fire pot and feeling for heat. Visually confirm that the igniter is protruding approximately 13mm / 0.5 inches in the fire pot. If not operating properly, follow Manual Start-up Procedure to continue use of grill; however, call Customer Service for assistance or a replacement part.
	Insufficient Air Flow Through Fire pot	Check fire pot for ash build-up or obstructions. Follow Care and Maintenance instructions for ash build-up. Check fan. Ensure it is working properly and air intake is not blocked. Follow Care and Maintenance instructions if dirty.
Flashing Dots On LCD Screen	The Igniter Is On	This is not an error that effects the grill. Used to show that the unit has power and is in Start-Up mode (igniter is on). The igniter will turn off after five minutes. Once the flashing dots disappear, the grill will begin to adjust to the desired temperature selected.
Flashing Temperature On LCD Screen	Grill Temperature Is Below 65°C /150°F	This is not an error that effects the unit; however, it is used to show that there is some risk that the fire could go out. Check hopper for sufficient fuel or if there is an obstruction in the feed system. Remove pellets and follow Care and Maintenance instructions. Check grill temperature probe and follow Care and Maintenance instructions if dirty. Check fire pot for ash build-up or obstructions, and follow Care and Maintenance instructions for ash build-up. Check fan. Ensure it is working properly and air intake is not blocked. Follow Care and Maintenance instructions if dirty. Check auger motor to confirm operation (rotation), and ensure there is no blockage in the auger tube.

"ErH" Error Code	The Unit Has Overheated, Possibly Due To Grease Fire Or Excess Fuel.	Press the Power Button to turn the unit off, and allow grill to cool. Follow Care and Maintenance instructions. After maintenance, remove pellets, and confirm positioning of all component parts. Once cooled, press the Power Button to turn the unit on, then select desired temperature. If error code still displayed, contact Customer Service.
"ErR" Error Code	Temperature probe wire not making connection.	Remove hopper access panel (see Electric Wire Diagram for diagram), and check for any damage to the Temperature Probe wires. Ensure Temperature Probe molex connectors are firmly connected, and connected correctly, to the Control Board.
"ErP" Error Code	Unit Not Turned Off Properly When Last Connected To Power.	Safety feature prevents an automatic restart. Press the Power Button to turn the unit off, wait two minutes, then press the Power Button to turn the unit on again. Turn Temperature Control Dial to SMOKE or desired temperature. If error code still displayed, contact Customer Service.
	Power Outage While Unit In Operation.	
"noP" Error Code	Bad Connection At Connection Port	Disconnect meat probe from connection port on the Control Board, and reconnect. Ensure the meat probe adapter is firmly connected. Check for signs of damage to the adapter end. If still failed, call Customer Service for replacement part.
	Meat Probe Damaged	Check for signs of damage to the wires of the meat probe. If damaged, call Customer Service for replacement part.
	Faulty Control Board	Control Board needs to be replaced. Contact Customer Service for a replacement part.
Grill Temperature on SMOKE is too high	"P" Setting is too LOW	Push the "P" SET button, and increase the "P" setting.
Grill Will Not Achieve Or Maintain Stable Temperature	Insufficient Air Flow Through Fire pot	Check fire pot for ash build-up or obstructions. Follow Care and Maintenance instructions for ash build-up. Check fan. Ensure it is working properly and air intake is not blocked. Follow Care and Maintenance instructions if dirty. Check auger motor to confirm operation, and ensure there is no blockage in the auger tube. Once all the above steps have been done, start the grill, set temperature to SMOKE and wait for 10 minutes. Check that the flame produced is bright and vibrant.
	Lack Of Fuel, Poor Fuel Quality, Obstruction In Feed System	Check hopper to check that fuel level is sufficient, and replenish if low. Should the quality of wood pellets be poor, or the length of the pellets too long, this may cause an obstruction in the feed system. Remove pellets and follow Care and Maintenance instructions.
	Temperature Probe	Check status of temperature probe. Follow Care and Maintenance instructions if dirty. Contact Customer Service for a replacement part if damaged.
Grill Produces Excess Or Discolored Smoke	Grease Build-Up	Follow Care and Maintenance instructions.
	Wood Pellet Quality	Remove moist wood pellets from hopper. Follow Care and Maintenance instructions to clean out. Replace with dry wood pellets.
	Fire pot Is Blocked	Clear fire pot for ash and other debris. Follow Hopper Priming Procedure .
	Insufficient Air Intake For Fan	Check fan. Ensure it is working properly and air intake is not blocked. Follow Care and Maintenance instructions if dirty.
Frequent Flare-Ups	Cooking Temperature	Attempt cooking at a lower temperature. Grease does have a flash point. Keep the temperature under 176°C / 350°F when cooking highly greasy food.
	Grease Build-Up On Cooking Components	Follow Care and Maintenance instructions.

ELECTRICAL WIRE DIAGRAM

The Digital Control Board system is an intricate and valuable piece of technology. For protection from power surges and electrical shorts, consult the wire diagram below to ensure your power source is sufficient for the operation of the unit.

PB – ELECTRIC REQUIREMENTS 110-120V, 60HZ, 275W, 3-PRONG GROUNDED PLUG

NOTE: Electrical components, passed by product safety testing and certification services, comply with a testing tolerance of $\pm 5-10$ percent.

ENGLISH

LOCATE AND REMOVE THE EIGHT SCREWS OF ACCESS PANEL ON UNDERSIDE OF UNIT

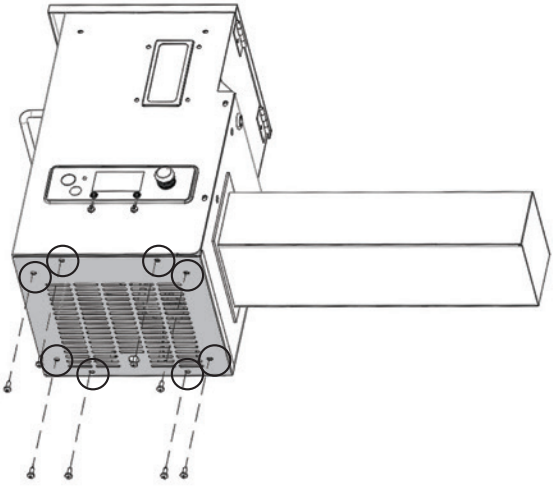

FUEL INPUT RATING:
1.12 KG/H
(2.48 LB/H)

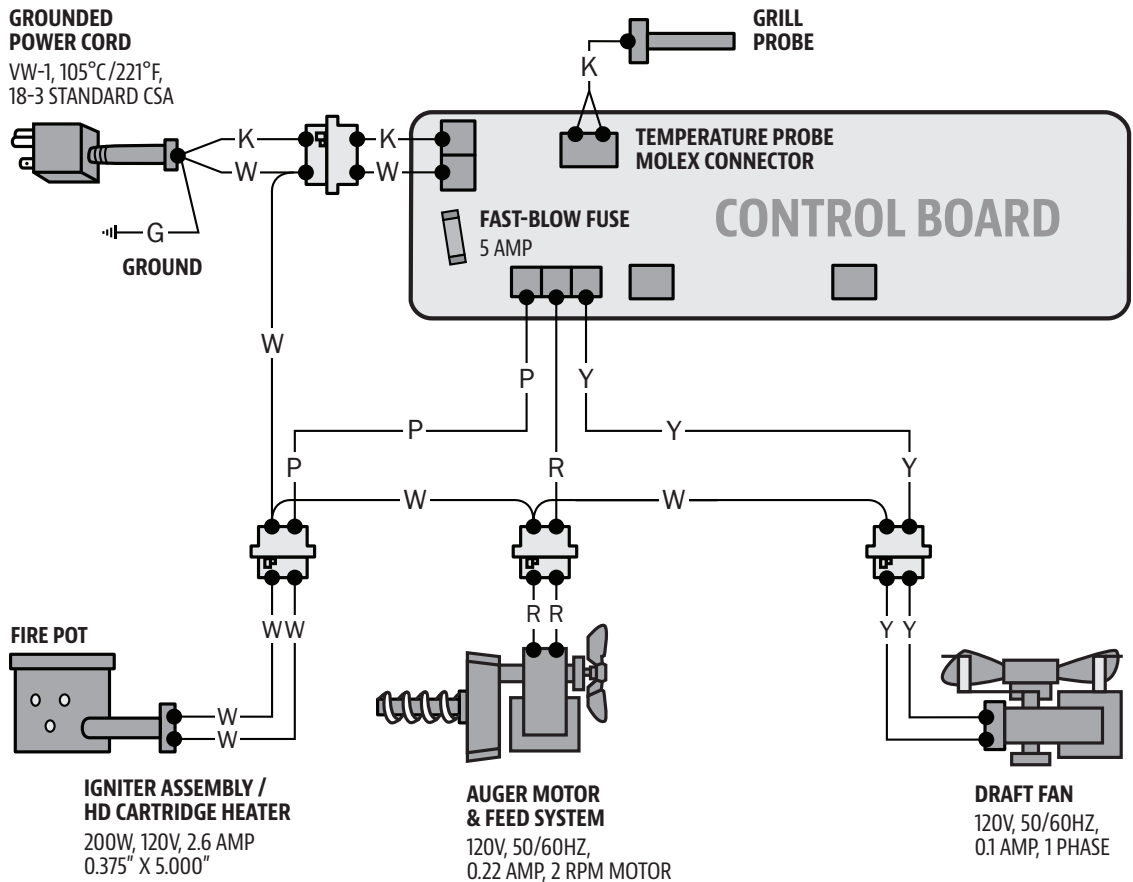

INDEX

- W : WHITE
- Y : YELLOW
- P : PURPLE
- R : RED
- K : BLACK
- G : GREEN



WOOD PELLET GRILL & SMOKER

**MODEL: PB5000SP
10569/10536
SPORTSMAN**

Diagram #	Item #	Description
35	74069	Auger box Housing
47	74250	Auger Box Housing/Barrel Gasket
40	74076	Auger bushing
37	31151	Auger Flighting (shaft)
41	70102	Auger motor
39	74072	Auger motor shaft bolt
38	74073	Auger motor shaft lock nut
9	20318	Barrel
3	20062	Barrel Lid
5	74050	Barrel Lid Hinge - Left
8	74051	Barrel Lid Hinge - Right
2	60325	Bezel/decorative washer 1" (2 per grill)
21	74328	Bottle Opener
50	31570	Bottom shelf
32	80108	Control board
20	60065	Cooking Grid - porcelain coated cast iron - 9.3" x 19.5" - 2 per grill
19	60064	Cooking Grid (upper) - porcelain coated steel - 17.5" x 7.2"
7	31166	Exhaust Louver - 16.8"
36	70133	Fan
49	74254	Firepot - includes Igniter Locking Screw
24	31291	Flame broiler adjusting bar
22	31292	Flame broiler adjusting bar handle
26	31143	Flame broiler bottom -
23	31141	Flame broiler slide cover
17	31516	Front shelf
18	31319	Front shelf bracket (left)
15	31314	Front shelf bracket (right)
13	74400	Grease Bucket
14	74224	Handle - for serving tray - 2 per grill
12	74222	Handle (side) - tray holder
31	76148	Hopper access panel
25	20058	Hopper and feed assembly - with all electrical components
30	20059	Hopper Box - Shell Only

44	74091	Hopper cleanout bolt
42	74093	Hopper cleanout plug
43	74092	Hopper cleanout slide
28	31493	Hopper Lid
29	PB700TG-005-ROO	Hopper Screen
48	74251	Hopper/Auger Box gasket
34	70112	Igniter - 200 watt
53	31500	Leg - left back
46	31497	Leg - left front
54	31501	Leg - right back
52	31499	Leg - right front
1	PB340TG-014-ROO	Lid handle
6	74403	Lid Stopper - Black
4	PBIOOOXL-028-R01	Logo Plate
33	70110	Power cord
45	PBIOOOXL-025-ROO	Probe
16	70128	Probe bracket/shield
55	20060	Screw package
10	74223	Serving tray - stainless steel
27	60333	Spice Box
11	PBIOOOXL-044-ROO	Tool Hanger - Ipc - w/washer, lock washer, screw
51	60334	Wheel - 6" - 2 per grill



WOOD PELLET GRILL & SMOKER

MODEL: PB5000SP
10569/10536
SPORTSMAN

