



PELLET STOVE P960 - P960 F - P961

Robeys
A PASSION FOR QUALITY



The instruction manual is an integral part of the product.

**INSTRUCTIONS FOR
INSTALLATION, USE AND
MAINTENANCE**

PIAZZETTA PELLET BOILERS AND STOVES SUPPLEMENTARY INSTALLATION INSTRUCTIONS FOR THE UK MARKET TO BE READ IN CONJUNCTION WITH THOSE IN THE INSTRUCTION BOOKLET

READ THE INSTRUCTION BOOKLET AND THESE SUPPLEMENTARY INSTRUCTIONS CAREFULLY BEFORE INSTALLATION

These instructions together with those in the instruction booklet cover the basic principles to ensure the satisfactory installation of the stove, although detail may need slight modification to suit particular local site conditions.

In all cases the installation must comply with current Building Regulations, Local Authority Byelaws and other specifications or regulations as they affect the installation of the stove. It should be noted that the Building Regulations requirements may be met by adopting the relevant recommendations given in British Standards BS 8303, BS EN 15287-1:2007 as an alternative means to achieve an equivalent level of performance to that obtained following the guidance given in Approved Document J.

Please note that it is a legal requirement under England and Wales Building Regulations that the installation of the stove is either carried out under Local Authority Building Control approval or is installed by a Competent Person registered with a Government approved Competent Persons Scheme. HETAS Ltd operate such a Scheme and a listing of their Registered Competent Persons can be found on their website at www.hetas.co.uk.

CO Alarms:-

Building regulations require that when ever a new or replacement fixed solid fuel or wood/biomass appliance is installed in a dwelling a carbon monoxide alarm must be fitted in the same room as the appliance. Further guidance on the installation of the carbon monoxide alarm is available in BS EN 50292:2002 and from the alarm manufacturer's instructions.

Provision of an alarm must not be considered a substitute for either installing the appliance correctly or ensuring regular servicing and maintenance of the appliance and chimney system.

HEALTH AND SAFETY PRECAUTIONS

Special care must be taken when installing the stove such that the requirements of the Health and Safety at Work Act are met.

Handling

Adequate facilities must be available for loading, unloading and site handling.

Fire Cement

Some types of fire cement are caustic and should not be allowed to come into contact with the skin. In case of contact wash immediately with plenty of water.

Asbestos

This stove contains no asbestos. If there is a possibility of disturbing any asbestos in the course of installation then please seek specialist guidance and use appropriate protective equipment.

Metal Parts

When installing or servicing this stove care should be taken to avoid the possibility of personal injury.

PREPARATORY WORK AND SAFETY CHECKS IMPORTANT WARNING

This stove must not be installed into a chimney that serves any other heating appliance. There must not be an extractor fan fitted in the same room as the stove as this can cause the stove to emit fumes into the room.

Chimney

Note: The flue is under a small positive pressure so all flue joints must be sealed with a suitable high temperature silicone sealant to ensure there is no flue product leakage into the room.

For the stove to perform satisfactorily the chimney height must be sufficient to ensure an adequate draught of approximately 12 Pa so as to clear the products of combustion and prevent smoke problems into the room.

NOTE: A chimney height of not less than 3.5 metres measured vertically from the outlet of the stove to the top of the chimney should be satisfactory. If using factory made metal flue pipe refer to the detailed appliance instructions. Alternatively the calculation procedure given in EN 13384-1 may be used as the basis for deciding whether a particular chimney design will provide sufficient draught.

Please Note, this appliance has been tested by the manufacturers and works on a 3.5m straight flue.

The outlet from the chimney should be above the roof of the building in accordance with the provisions of Building Regulations Approved Document J.

If installation is into an existing chimney then it is essential that it is sound and have no cracks or other faults which might allow fumes into the house. Remedial action should be taken, if required, seeking expert advice, if necessary. If it is found necessary to line the chimney then a flue liner suitable for solid fuel must be used in accordance with Building Regulations Approved Document J.

Any existing chimney must be clear of obstruction and have been swept clean immediately before installation of the stove. If the stove is fitted in place of an open fire then the chimney should be swept one month after installation to clear any soot falls which may have occurred due to the difference in combustion between the stove and the open fire.

If there is no existing chimney then either a prefabricated block chimney in accordance with Building Regulations Approved Document J or a twin walled insulated stainless steel flue to BS 4543 can be used. These chimneys must be fitted in accordance with the manufacturer's instructions and Building Regulations.

Please Note, pellet stoves have a flue outlet size of 80mm and are suitable for use with 100 and / or 125mm flues depending on site conditions.

Please refer to Robeys website, Brochure Downloads / Help & Advice for flue sizes etc.

Any bend in the chimney or connecting fluepipe should not exceed 45°. 90° bends should not be used except at the stove connection to the flue.

Combustible material should not be located where the heat dissipating through the walls of fireplaces or flues could ignite it. Therefore when installing the stove in the presence of combustible materials due account must be taken of the guidance on the separation of combustible material given in Building Regulations Approved Document J and also in these stove instructions.

Adequate provision e.g. easily accessible soot door or doors must be provided for sweeping the chimney and connecting fluepipe, also to permit visual checks on the integrity of the flue when the appliance is serviced. Ensure that all access doors in the flue can be adequately sealed after service.

Hearth

The hearth should be able to accommodate the weight of the stove and its chimney if the chimney is not independently supported. The weight of the stove is indicated in the brochure.

The stove should always be installed on a non-combustible hearth or base of a size and construction that is in accordance with the provisions of the current Building Regulations Approved Document J.

The clearance distances to combustible material beneath, surrounding or upon the hearth and walls adjacent to the hearth should comply with the guidance on the separation of combustible material given in Building Regulations Approved Document J and also in these stove instructions.

If the stove is to be installed on a combustible floor surface, it must be covered with a non-combustible material at least 12mm thick and extending in front and to the sides of the stove as shown in the detailed instructions, and in accordance with Building Regulations Approved Document J.

Combustion air supply

In order for the stove to perform efficiently and safely there should be an adequate air supply into the room in which the stove is installed to provide combustion air. This is particularly necessary if the room is double-glazed and well sealed. It may be necessary to increase the air vent size in property with low air permeability ($\leq 5.0 \text{ m}^3 /(\text{h}.\text{m}^2)$).

The provision of air supply to the stove must have a total free area at least equal to the size given in the Technical Data section in the instructions and be in accordance with current Building Regulations Approved Document J. An opening window is not appropriate for this purpose.

IMPORTANT NOTE: If applicable and the appliance is being fitted within a fireplace recess, specialist advice should be sought before fitting any permanent ventilation within this area.

For inset stoves built into a fireplace or enclosure, convection air vents must be fitted at high and low level to ventilate the chamber with minimum free area as stated in the Technical Data section.

Connection to chimney

Stoves have a rear flue connector that allows connection to either a masonry chimney or a prefabricated factory made insulated metal chimney in accordance with the instructions. In some cases it will be necessary to fit an adaptor to increase the diameter of the flue to the 150 mm section of the chimney or liner. Ensure that there is access to sweep the flue completely including the internal parts of the stove.

Electrical Services

The installation of any electrical services during the installation of this appliance must be carried out by a registered competent electrician and in accordance with the requirements of the latest issue of BS 7671

Carbon Monoxide Alarm

A carbon monoxide alarm complying with BS EN 50292 must be fitted in the same room as the appliance. It should be positioned on the ceiling at least 300mm from any wall or, if it is located on a wall, as high up as possible (above any doors and windows) but not within 150mm of the ceiling. The alarm should also be between 1m and 3m horizontally from the appliance.

Commissioning and handover

Ensure loose parts are fitted in accordance with the instructions given in the instruction booklet.

On completion of the installation allow a suitable period of time for any sealants and cement to dry out. On Thermo boiler stoves ensure that the system and stove has been fully vented and that system controls are operating before lighting. When lit check to ensure that all smoke and fumes are taken from the stove up the chimney and emitted safely to atmosphere. Follow the detailed instructions in the relevant section.

On completion of the installation and commissioning ensure that the operating instructions for the stove are left with the customer. Ensure to advise the customer on the correct use of the appliance. Advise the correct pellet fuel to be used on the stove and warn them to use only the recommended fuels for the stove. It is important that the fuel is stored in a dry place, particularly once a bag is opened. If bulk fuel storage is used expert advice should be sought.

Advise the user what to do should smoke or fumes be emitted from the stove. The customer should be warned to use a fireguard to BS 8423:2002 in the presence of children, aged and/or infirm persons.

SUPPLEMENTARY OPERATING INSTRUCTIONS FOR THE UK MARKET TO BE READ IN CONJUNCTION WITH THOSE IN THE INSTRUCTION BOOKLET

<p><u>READ THE INSTRUCTION BOOKLET AND THESE INSTRUCTIONS CAREFULLY BEFORE USING THE STOVE</u></p>

WARNING NOTE

Properly installed, operated and maintained this stove will not emit fumes into the dwelling. Fume emission is potentially dangerous and must not be tolerated. In the event of fume emission from the appliance, then the following immediate action should be taken: -

- (a) Switch off the stove immediately
- (b) Open doors and windows to ventilate room and then leave the premises
- (c) When safe to do so, check for flue or chimney blockage and clean if required
- (d) Do not attempt to relight the stove until the cause of the fume emission has been identified and corrected. If necessary seek expert advice.

The most common cause of fume emission is flueway or chimney blockage. For your own safety these must be kept clean at all times.

IMPORTANT NOTES

General

Before lighting the stove check with the installer that the installation work and commissioning checks described in the installation instructions have been carried out correctly and that the chimney is clean, sound and free from any obstructions. As part of the stoves' commissioning and handover the installer should have shown you how to operate the stove correctly.

CO Alarm

Your installer should have fitted a CO alarm in the same room as the appliance. If the alarm sounds unexpectedly, follow the instructions given under "Warning Note" above.

Use of fireguard

When using the stove in situations where children, aged and/or infirm persons are present a fireguard must be used to prevent accidental contact with the stove. The fireguard should be manufactured in accordance with BS 8423:2002.

Chimney cleaning

The chimney should be swept at least twice a year. It is important that the flue connection and chimney are swept prior to lighting up after a prolonged shutdown period.

The installer will have provided access for flue cleaning, such as a soot door. After sweeping the chimney the stove flue outlet and the flue pipe connecting the stove to the chimney must be cleaned. It is essential that all seals are secure and effective before reusing the stove. This must only be carried out by suitably qualified personnel.

Periods of Prolonged Non-Use

If the stove is to be left unused for a prolonged period of time then it should be given a thorough clean to remove ash and unburned fuel residues.

Extractor fan

There must not be an extractor fan fitted in the same room as the stove as this can cause the stove to malfunction and emit smoke and fumes into the room.

Aerosol sprays

Do not use an aerosol spray on or near the stove when it is alight.

Chimney Fires

If the chimney/flue is thoroughly and regularly swept, chimney fires should not occur. However, in the unlikely event of a chimney fire turn off the stove immediately and isolate the mains electricity supply. Do not open the door of the stove. This should cause the chimney fire to go out. If the chimney fire does not go out when the above action is taken then the fire brigade should be called immediately. Do not relight until the stove, chimney and flueways have been cleaned and examined by a professional.

Permanent air vent

The stove requires a permanent and adequate air supply in order for it to operate safely and efficiently. In accordance with current Building Regulations and the instructions the installer will have fitted a permanent air supply vent into the room in which the stove is installed to provide combustion air. This air vent should not under any circumstances be shut off or sealed.

USER OPERATING INSTRUCTIONS

Please read the important notices given above before referring to the main instruction book for detailed operating instructions.

Recommended fuels

The stoves are designed to burn good quality wood pellets only, no other fuel can be used. The pellets must be kept dry at all times otherwise malfunction can occur. Check the section 'Fuels' for detailed specification. Do not attempt to burn rubbish on the stove.

Door operation

Do not open the door during operation, the door and its seal are important functional components. If the door is accidentally opened whilst the stove is running it will switch off.

Lighting of fire

Ensure the grate and support are cleaned and free of any unburned pellets before use. Do not empty the grate into the hopper. Check the hopper contains sufficient fuel. On boiler stoves ensure that the water system is full, set to the correct pressure and the controls are working satisfactorily. The installer will have explained use of the controls.

The stove can be lit and programmed using the keypad on the stove or (where applicable) the remote control. See the detailed instructions. The ignition and operation of the stove is then automatically controlled and monitored by the control system. Do not be concerned if the stove appears to be inactive for several minutes during the ignition process as it goes through various self checks. Do not be tempted to open the door as this will stop the ignition process.

Refuelling

Keep the hopper well filled but do not allow fuel to spill into the top of the stove.

Cleaning and maintenance

The instructions detailed in the section "Maintenance" in the instruction booklet should be followed. The grate and glass should be cleaned daily and other items at the specified intervals as shown in the instructions.

Spare Parts

Spare parts can be obtained from Robeys Limited. Telephone 01773 820 940

Trouble shooting

The instructions detailed in the relevant section in the instruction booklet should be followed.

Dear client,

We thank you for choosing one of our products, the result of technological expertise and continued research in pursuit of a superior product in terms of safety, reliability and features.

In this manual you will find all the information and useful advice necessary to get the most out of your appliance in total safety.

DT2810001-00

IMPORTANT INFORMATION

DT2810288-02

- This manual has been prepared by the manufacturer and constitutes an integral part of the product, and must accompany it throughout its life. In the event of sale or relocation of the product make sure this booklet accompanies it, since the information contained in it is addressed to the purchaser and to anyone involved in the installation, use and maintenance of the product.
- Read the instructions and the technical information contained in this manual carefully, before proceeding with installation, use or any repairs.
- The observance of the instructions and technical information in this manual guarantees the safety of the user and the product, a more efficient operation and an increased lifespan.
- The product's installation and use should conform to the manufacturer's instructions and to local bylaws.
- However, when carrying out any operation we recommend that you follow carefully the instructions contained in this manual, and that you keep it at your disposal.
- Installation, electrical connection, checks, maintenance and repairs are operations which must be carried out exclusively by qualified and authorised personal with specialised knowledge of the product.
- Before installing the product read all instruction booklets relating to installation of the cladding, the ventilation kit and any other accessories.
- Be very careful when moving any ceramic components.
- Check that the floor where the product is to be installed is exactly level.
- To help correct potential unevenness and irregularities a sheet of adhesive fibreglass accompanies the product.
- Do not block the electrical socket; it should be close to the unit but accessible.
- Connect the pellet stove to the electricity supply only after it has been connected by an expert to the flue system.
- The plug at the end of the power supply cable must be easily accessible after installation.
- Use only regulation wood pellets (refer to section entitled "Fuel").
- Never use liquid fuels to light the stove or to relight the embers.
- Ensure that the area where the stove is installed is properly ventilated while the stove is lit.
- In the event of technical faults the fuel supply will be interrupted. Restart the stove only after having eliminated the cause of the fault.
- The wall where the product is to be placed should not be of wood or any other flammable material; furthermore it is important to maintain safety distances (refer to section entitled "Prevention of domestic fires" contained in the stove's manual for use and maintenance).
- Do not remove the protective grille from the fuel storage tank.
- Any build-up of unused pellets in the burner left over from repeated failed ignitions must be removed before lighting the stove.
- The operation of the stove can cause surfaces, handles, flue system and glass to become extremely hot. Touch these parts during operation only with protective clothing or other specialised equipment.
- Because of the build-up of heat on the glass, take care that those who are unaware of the workings of the stove do not delay in the installation area.
- Keep children informed of safety measures to be followed when the stove is operational and at other times.
- Creaking may be heard while the stove is in operation or cooling down. This is not to be considered a defect, but is a consequence of thermal expansion of the component materials.



In the event of difficulties or if you are unable to understand the instruction manual contact your local Piazzetta dealer.

It is forbidden to place objects which are not heat-resistant on top of the stove or within the prescribed minimum safety zone.

It is forbidden to open the door while the stove is in operation or to operate the stove when the glass is broken.

The assembly of the cover should be undertaken by two people (follow the assembly instructions in the attached booklet).

Plans and diagrams are supplied as examples at the manufacturer's discretion; in the pursuit of a policy of continuous development and innovation the manufacturer may, without prior warning, make any modifications deemed appropriate.

This document is the property of Gruppo Piazzetta S.p.A.; it may not be divulged in part or in whole to third parties without written permission from Gruppo Piazzetta S.p.A. Gruppo Piazzetta S.p.A. reserves all its statutory rights.

REFERENCE STANDARDS

DT2810289-03

DIN 18894	Solid fuel stoves and fireplaces – Pellet stoves – Requirements, testing and marking
UNI 10344	Heating of buildings. Calculation of energy requirements
UNI 10683	Wood-fired heat generators, Installation requirements
UNI 10847	Single flue systems for liquid and solid fuel generators – Maintenance and control – Guidelines and procedures
UNI 7129	Gas installations for domestic use fired by mains gas supply
DIN 51731 class HP2	Fuels
ÖNORM M7135	Fuels
CEI EN 60335-1	Safety of household and similar electrical appliances.
CEI EN 50165÷1997	Electrical equipment of non-electric appliances for household and similar purposes.
EN 1856-1-2	Chimneys – Requirements for metal chimneys – Metal liners and connecting flue pipes
EN 1443	Chimneys – General requirements

SECTION	TITLE	PAGE
1.0	GENERAL RULES	10
1.1	SINGLE FLUE WAY OR CHIMNEY	11
1.2	SOOT INSPECTION	11
1.3	CHIMNEY STACK	12
1.4	FRESH AIR INTAKE	13
1.5	INSTALLATION ENVIRONMENT	13
1.6	LOAD CAPACITY OF THE FLOOR	14
1.7	HEATING CAPACITY	14
1.8	MINIMUM SAFETY DISTANCES	15
1.9	FLUE WAY	15
1.10	CONNECTING TO A CONVENTIONAL CHIMNEY	17
1.11	USING AN EXTERNAL FLUE	18
1.12	PREVENTION OF DOMESTIC FIRES	18
2.0	FEATURES AND TECHNICAL DATA	19
2.1	FEATURES	19
2.2	ACCESSORIES AND EQUIPMENT	19
2.3	TECHNICAL DATA	19
2.4	PRODUCT IDENTIFICATION DATA	20
2.5	DIMENSIONS	20
3.0	FUEL	23
4.0	PREPARING FOR THE INSTALLATION	23
5.0	INSTALLATION	24
5.1	MULTIFUOCO SYSTEM	24
5.2	ELECTRICAL CONNECTION AND ROOM SENSOR CONNECTION	27
5.3	INSTALLING THE EXTERNAL THERMOSTAT	27
5.4	INSTALLING THE Y PIECE (OPTIONAL)	28
6.0	USE	29
6.1	LOADING THE PELLETS	29
6.2	REMOTE CONTROL	29
6.3	LIGHTING FOR THE FIRST TIME	30
6.4	START-UP AND NORMAL OPERATION	30
6.5	CONTROL PANEL	34
6.6	SETTING THE LANGUAGE	35
6.7	MODE OF OPERATION P960F ONLY	35
6.8	PROGRAMMING P960F	36
6.9	STOVE MODE	38
6.10	OVEN MODE	39
6.11	PROGRAMMING P960 - P961	42
6.12	TIMER	44
6.13	MULTICOMFORT	50
6.14	MODIFYING THE TRANSMISSION UNIT	52
6.15	HOW THE MULTIFUOCO SYSTEM WORKS	52
6.16	SAFETY DEVICES	53
6.17	OPENING THE DOOR	56
6.18	HUMIDIFIER	56
6.19	DISPOSAL OF ASHES	56
7.0	MAINTENANCE	57
7.1	CLEANING THE GRATE AND GRATE SUPPORT	57
7.2	CLEANING THE ASH TRAY	57
7.3	CLEANING THE FIREBOX	57
7.4	CLEANING THE COMBUSTION CHAMBER	58
7.5	CLEANING THE SMOKE CHAMBER	59
7.6	CLEANING THE FLUE SYSTEM	59
7.7	CLEANING THE CERAMIC CLADDING	59
7.8	CLEANING THE ENAMELLED METAL PARTS	59
7.9	CLEANING THE GLASS (DAILY)	59
7.10	REPLACING THE GLASS	60
7.11	REPLACING THE REMOTE CONTROL BATTERY	60
7.12	CLEANING THE FANS	60
7.13	WHEN NOT IN USE	60
7.14	EXTRAORDINARY MAINTENANCE	60
8.0	TROUBLESHOOTING	61
8.1	REPLACING THE FUSES	64
	CERTIFICATE OF CONFORMITY	65
	FLUE PARAMETER SETTING GUIDE	67

Ensure that the installation of your product conforms to all the indications given below.

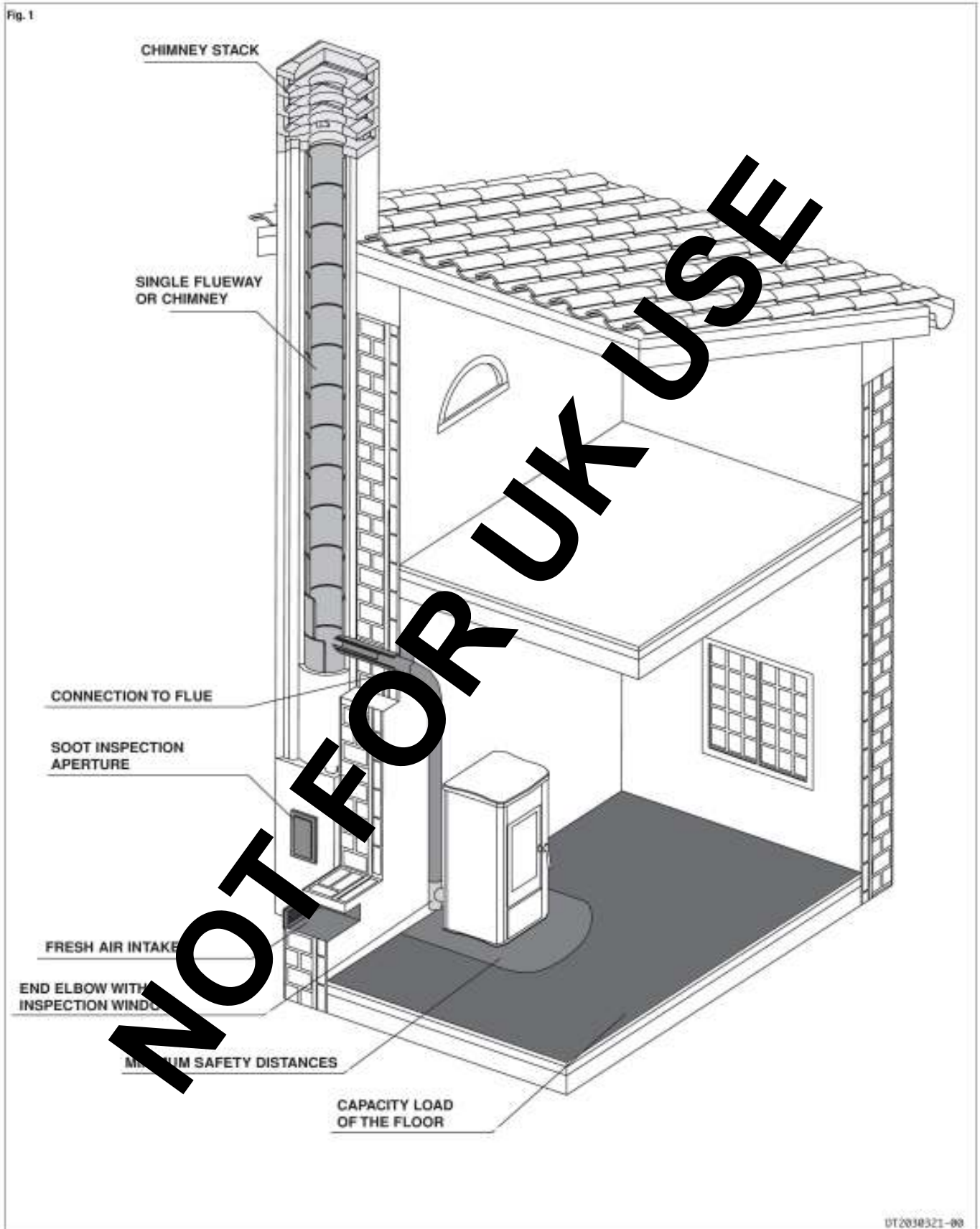

1.1 Single flueway or chimney - Fig. 2 / 6

DT2010024-00

Every appliance must have a vertical flue pipe operating by natural draught to discharge the combustion gases outdoors.

The flue must:

- comply with regulations in force in the place of installation of the appliance;
- be tight to the products of combustion, waterproof, suitably insulated, made with materials resistant to corrosion by the gases and to stress;
- be connected to just one stove, fireplace or extraction hood (Fig. 2);
- be properly sized, with constant free internal section, equal to or greater than the diameter of the flue pipe of the stove and at least 3.5 m in length (Fig. 2);
- be mainly in a vertical position with a deflection from the axis of no more than 45° (Fig. 2);
- be at a suitable distance from combustible or flammable materials, ensured by an air gap or suitable insulating material;
- be of uniform internal section, preferably round. Square or rectangular sections must have rounded corners with a radius of at least 20mm and a maximum ratio between the sides of 1.5 (Fig. 3-4-5). The walls must be smooth if possible and without narrowing. Bends must be regular and without discontinuity (Fig. 6).

⚠ It is forbidden to make fixed or mobile apertures on the flue pipe to connect appliances other than the one to which it is already connected.

⚠ It is forbidden to pass other air ducts or service pipes inside the flue pipe, however large it is.

⚠ If the flue pipe is an incorrect size or installed other than in compliance with the above instructions, Gruppo Piazzetta S.p.A. cannot be held liable for malfunctioning of the product, damage to property or injury to persons or animals.

1.2 Soot inspection - Fig. 1

DT2010031-00

- The flue must have a chamber for collecting solid matter and any condensate located below the connection and which may be easily inspected by means of an airtight door. (Fig.1)
- The bends connecting to the flue must have inspection points that allow the system to be checked, cleaned and maintained.

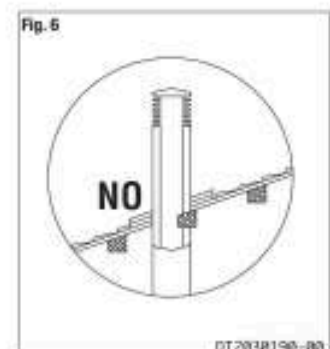
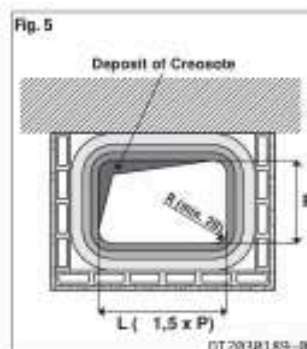
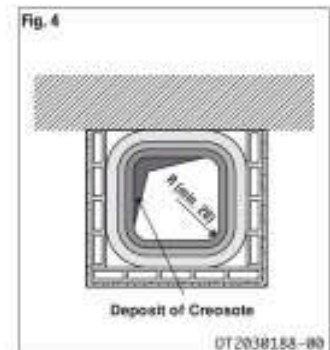
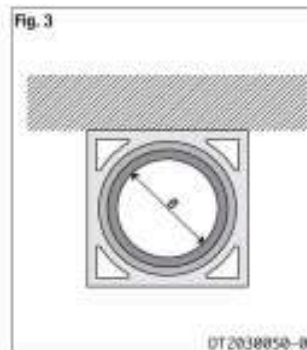
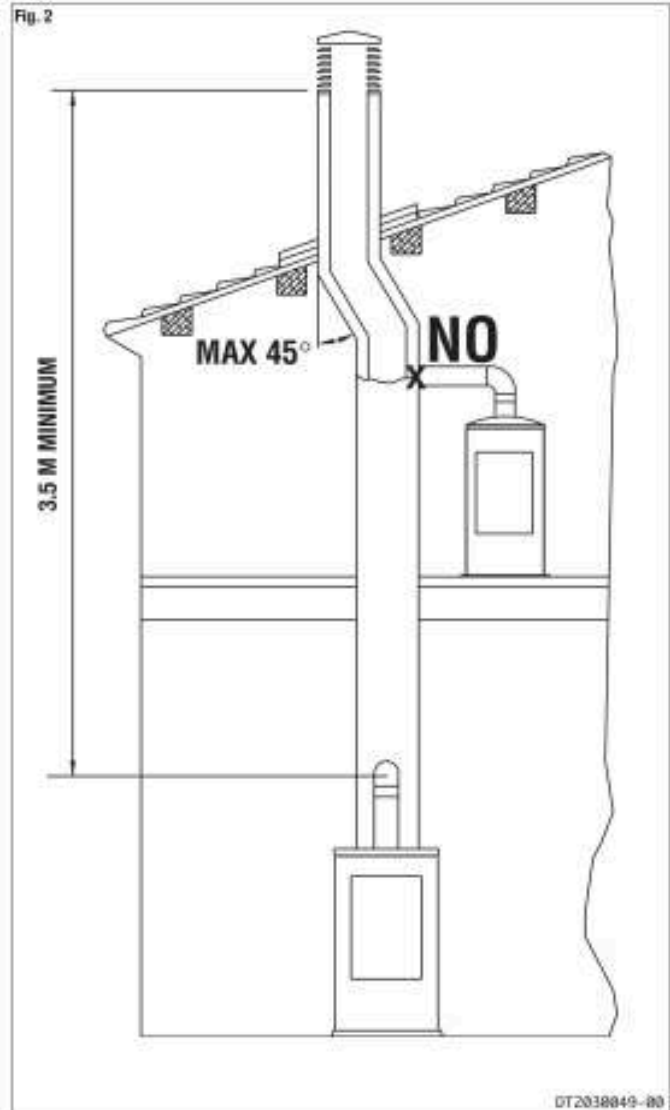

1.3 Chimney stack - Fig. 7 / 11

The flue must be fitted at the top with a device called a chimney stack, designed to aid dispersion of the products of combustion in the atmosphere.

The chimney stack must comply with the following requirements:

- it must have an internal section and shape the same as the flue;
- it must have a useful outlet section of not less than twice that of the flue;
- the part of the flue that emerges from the roof or remains in contact with the outside (e.g. in the case of an open loft), must be covered with brick or tile elements and well insulated. It must be built in such a way as to prevent the penetration of rain, snow and foreign matter into the flue and to ensure that in the event of winds from all directions and angle, discharge of the combustion products is assured (chimney stack with down-draught cowl);
- any buildings or other obstacles that are higher than the chimney stack must not be too close to the actual stack Fig.8, Fig.9;
- the chimney stack must be positioned in such a way as to ensure adequate dispersion and dilution of the products of combustion and outside the reflux area. The size and shape of this area differ according to the angle of inclination of the roof and it is therefore necessary to adopt the minimum heights shown in Fig.10,11;

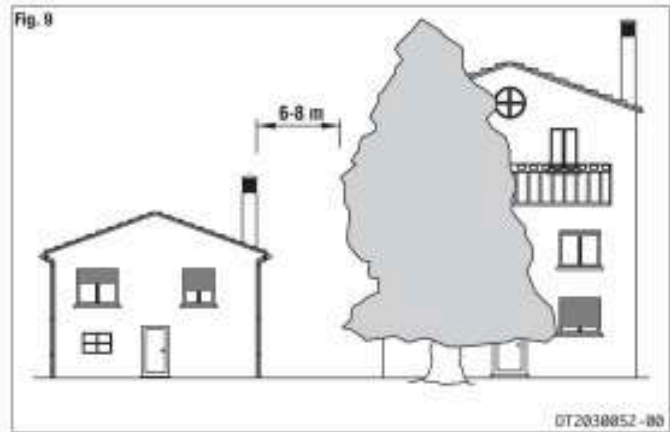
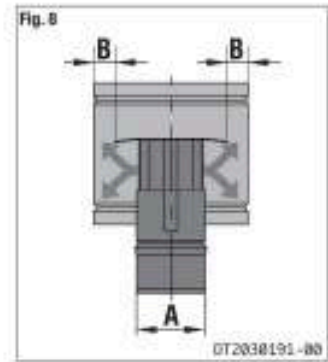
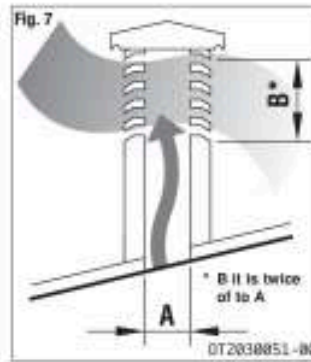

Example: Check the slope of the roof (column X), and the anticipated distance of the chimney stack from the axis of the ridge (column A); if the distance is greater than "A" the height of the chimney stack may be read in (column H); if the distance is less than "A" the chimney stack must rise above the ridge by 0.5 metres.

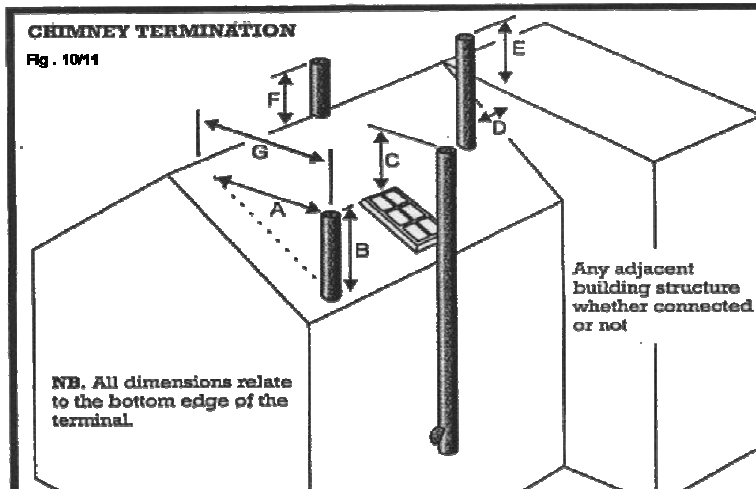

The illustration and table identify the minimum requirements as dictated by Building Regulations.

Dimension	Minimum distance measured from the top of the chimney construction, excluding any pot or terminal.
A	2.3 metres horizontally clear of the roof surface, eg. if the roof pitch is 45°, then the chimney should project 2.3 metres above it.
B	1 metre, provided A is satisfied, or 600mm above the ridge if G is less than 600mm.
C	1 metre above the top of any flat roof, and the top of any openable roof light, dormer window or ventilator, etc., if it is located within 2.3 metres.
D/E	If D is less than 2.3 metres, E shall be not less than 600mm.
F	600mm above the ridge.
G	Edge of chimney to roof ridge.

1.4 Fresh air intake - Fig. 12/15

The stove/fireplace must have the necessary air available to ensure proper combustion.

- Make sure that the room in which the stove/fireplace is to be installed has an air intake of at least the size indicated in the paragraph "Technical data".
- The fresh air intake may be protected by an external grille provided it does not reduce the minimum section of the recommended airflow and is in a position whereby it cannot be obstructed.

The air necessary for the fire may be obtained in different ways:

- **Figure 12** through an external grille direct to the room of installation;
- **Figure 13** with ducting through pipes direct to the room of installation, increasing the recommended minimum free cross section by at least 15%;
- **Figure 14** through a communicating hole from an adjacent room to the place of installation: this system may only be used if the air flows freely from the outside through fixed apertures;
- **Figure 15** from an adjacent room to the place of installation, but only if the air flows freely through apertures communicating with the outside.

1.5 Installation environment

The appliance must be installed in a location which allows safe and convenient use as well as easy maintenance. If the product being installed requires an electrical socket, the room must also be provided with an earthed power supply in accordance with current regulations.

- ⚠ **Do not install a wood-burning appliance in a bedroom, bath or shower room or in any room where another heating system not equipped with its own air supply (fireplace, stove etc.) has already been installed.**

The room or rooms adjacent to that where the appliance is to be installed must conform to the following requirements:

- ⚠ it must not be used as a car bay, a store for combustible material, nor for any activity which carries a risk of fire;
- ⚠ there must be no vacuum relative to normal atmospheric pressure as a result of the contrary draught created by a prior installation of an open fire or of an extractor system;
- ⚠ do not install two stoves, a stove and a fireplace or a stove and a wood-burning range etc. in the same location since the draught of one device can interfere with the draught of another;
- the use of equipment adapted for cooking food with non-extractor hoods is permissible only in rooms to be used as kitchens;
- _ equipment using gas type C is permitted (refer to regulations in force in the place of installation);

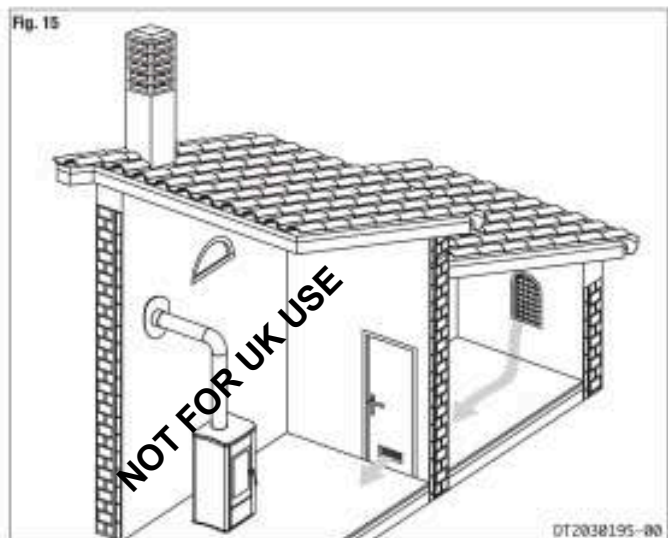
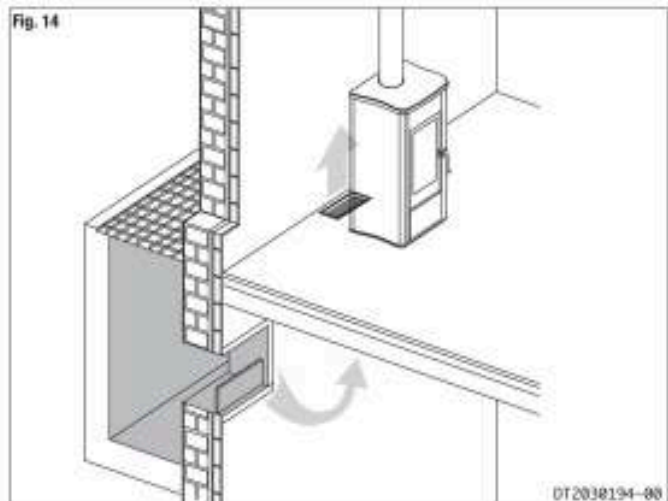
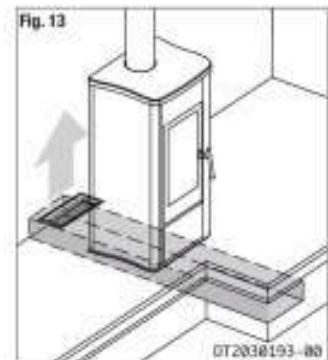

⚠ equipment using gas type B is not permitted (refer to regulations in force in the place of installation);

⚠ using the stove or fireplace simultaneously with shared ventilation systems is not permitted, whether with or without extractor fans. Similarly the use of other devices or equipment, such as air-conditioning systems or other heating systems which use fans to circulate air, is not permitted. These devices can cause a pressure drop in the environment of installation even if they are installed in adjacent, communicating rooms.

1.6 Capacity load of the floor

Check the load-bearing capacity of the floor, referring to the weight of the product given in the paragraph "Technical data".

If the floor does not have a suitable load-bearing capacity, adequate countermeasures must be taken, for example, by using a sheet metal plate to distribute the load.

1.7 Heating capacity

Check the heating capacity of the appliance by comparing the rated power given in the paragraph "Technical data" with the power required by the environment to be heated.

The energy requirement may be calculated approximately by multiplying the square metres of area by the height of the ceiling; the result is then multiplied by a coefficient, which depends on the degree of insulation of the building, that is, on internal and external factors of the dwelling:

- a) **Internal factors:** type of window and door frames, thickness of the insulation and walls, type of building materials, presence of stairwells, walls with extensive glazing, high ceilings, position of the rooms to be heated in relation to other adjacent heated or unheated rooms, ...
- b) **External factors:** geographical position, average outdoor temperature, exposure, wind speed, latitude, altitude, ...

Example of approximate calculation of the energy requirement to heat a fixed volume to 18/20° C:

The coefficient that is normally used is determined according to the real conditions as they occur case by case.

- From **0.04 to 0.05 kW** per cubic metre in a **well insulated environment**
- From **0.05 to 0.06 kW** per cubic metre in a **poorly insulated environment**.

3 rooms measuring 20m² X (H ceiling) 2.7m = 162 m³ (volume)

In an environment with a good degree of insulation, an average value (coefficient) of 0.045 kW may be taken

162 (volume) X 0.045 (kW) = 7.3 kW necessary (6300 kcal/h)

Conversion 1kW = 860 kcal/h

⚠ Consult a heating technician or engineer for a correct check and calculation of the requirement of the environments to be heated (see "Reference standards").

⚠ Rated power being equal, products with the Multi-fire system can evenly distribute heat throughout the rooms to be heated.

1.8 Minimum safety distances - Fig. 16/18

First of all decide the exact position for installation of the stove.

Check the minimum safe distances from heat sensitive or inflammable materials, from load bearing and other walls and also from wooden elements, furniture, etc.

The minimum distances are:

- A 20 cm from the wall behind the stove
- B 20 cm from the side wall
- C 80 cm in the heat radiation area and from the hot air fan

In the case of flooring that is heat sensitive or inflammable the floor should be protected with non-combustible insulating material, e.g. sheets of steel plate, marble, tiles, etc.

The minimum distances are:

- D 50 cm;
- E 30 cm (measured from the internal corner of the door opening).

⚠ Keep any combustible product well away from the stove when it is lit (minimum distance from the heat radiation area), for example: wooden furniture, curtains, carpets, combustible liquids, etc.

⚠ It is advisable to leave more than the indicated 20 cm free at the side of the stove to facilitate any maintenance on the appliance.

1.9 Flueway - Fig. 19-20

⚠ The pellet stove is not the same as other stoves. It has a forced draught of flue gas by a fan, which keeps the firebox in a vacuum and the entire flueway slightly pressurised. For this reason the flue must be completely airtight and correctly installed to ensure both trouble-free operation and user safety.

- The flueway must be made by specialised personnel or firms, as outlined below.
- The flue must be installed in such a way as to guarantee that periodic cleaning can be carried out without dismantling any parts whatsoever.
- Pipes should always be sealed with silicone (not cement-based sealants) or specially adapted gaskets/seals, which retain their strength and elasticity at high temperatures (250°C), and should be fixed with 3.9 mm ø self-tapping screws.

⚠ Do not install dampers or valves that could block the passage of flue gas.

⚠ Do not connect to a flueway into which other appliances (boilers, extractor hoods, etc.) discharge fumes or vapours.

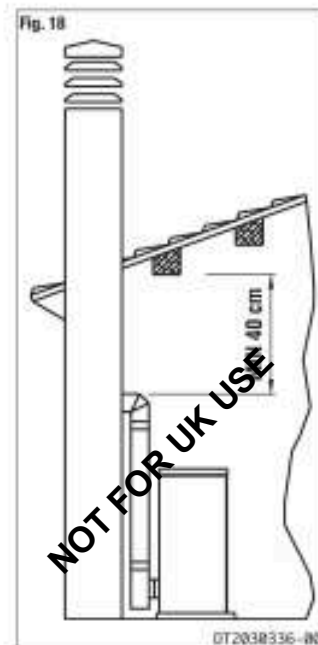
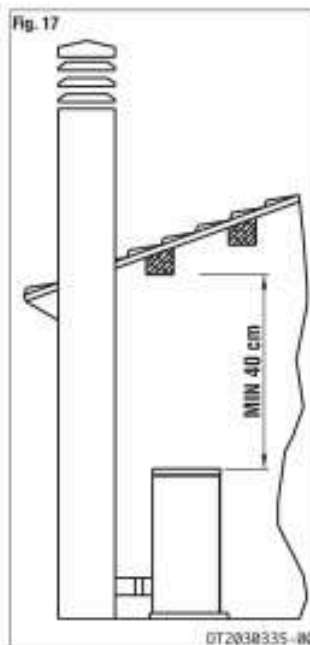
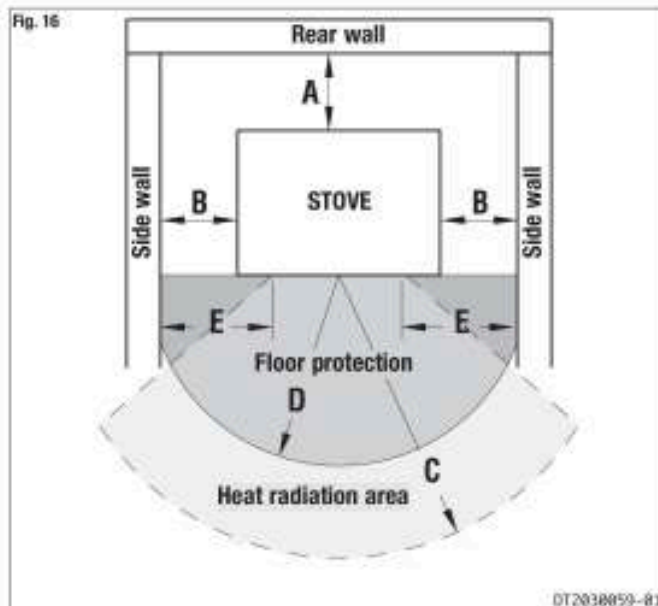

Pipes and maximum usable lengths

Pipes of painted aluminium-clad steel (minimum thickness 1.5mm), stainless steel (AISI 316) or enamelled steel (minimum thickness 0.5mm) with a nominal diameter of 80 or 100 mm (for pipes which run inside the flue maximum diameter 150 mm) can be used.

The male-female connectors must have a minimum length of 50 mm.

The diameter of the pipes depends on the type of installation. The stove was designed to take 80 mm diameter pipes but, as shown in Table 1, in some cases the use of double-lined 100 mm diameter pipes is recommended.

TABLE 1 – LENGTH PIPES		
TYPE OF INSTALLATION	WITH 80mm Ø PIPE	WITH DOUBLE-WALLED 100mm Ø PIPE
Maximum length (with three 90° bends)	4.5 m	8 m
For installations more than 1200m above sea level	-	Required
Maximum number of bends	3	4
Length of horizontal sections with minimum 3% gradient	2 m	2 m

⚠ Losses in pressure associated with a 90° bend can be compared to those incurred by one metre of pipe. An inspectable union-tee can be considered equivalent to a 90° bend.

EXAMPLE: : if installing a section greater than 4.5m in length with 80mm diameter pipe, calculate the maximum usable length in the following ways:

- If a maximum of **three 90° bends** are used, the maximum length of the section will be **4.5m**
- If a maximum of **two 90° bends** are used and bearing in mind that a 90° bend can be replaced by one metre of pipe, the maximum length of the section will be **4.5m+1m=5.5m**
- If a maximum of **one 90° bend** is used and bearing in mind that a 90° bend can be replaced by one metre of pipe, the maximum length of the section will be **4.5m+1m+1m=6.5m**

Where 100mm diameter pipe must be used, connect it to the stove flue outlet with a 80mm union-tee then use a 80mm 100mm adaptor (not supplied by Piazzetta) (Fig. 19).

Union-tee

The use of this type of fitting must allow for the collection of condensate mixed with soot, which builds up inside the pipe. It must also permit periodic cleaning of the flue without the need to disassemble the pipes.

This type of fitting can be bought at Piazzetta retail outlets together with the pipes.

An example is given below of a flueway connection, which allows complete cleaning without having to disassemble the pipes (Fig 20).

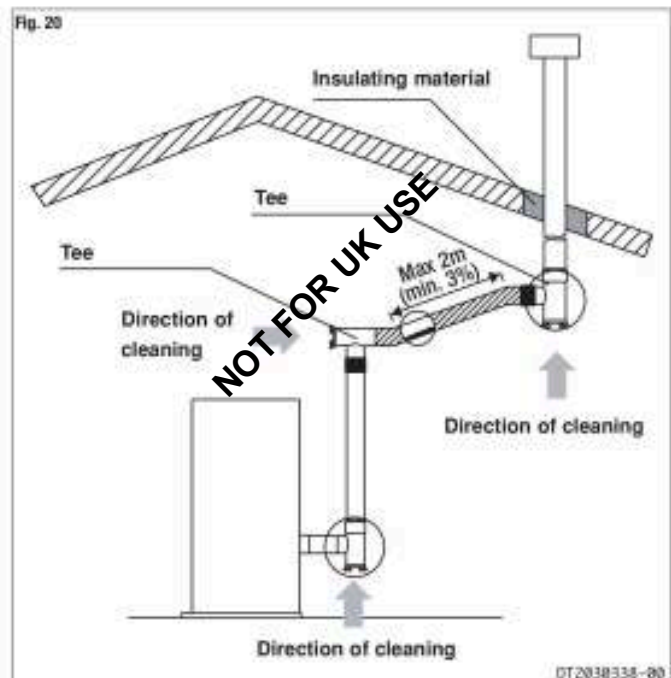
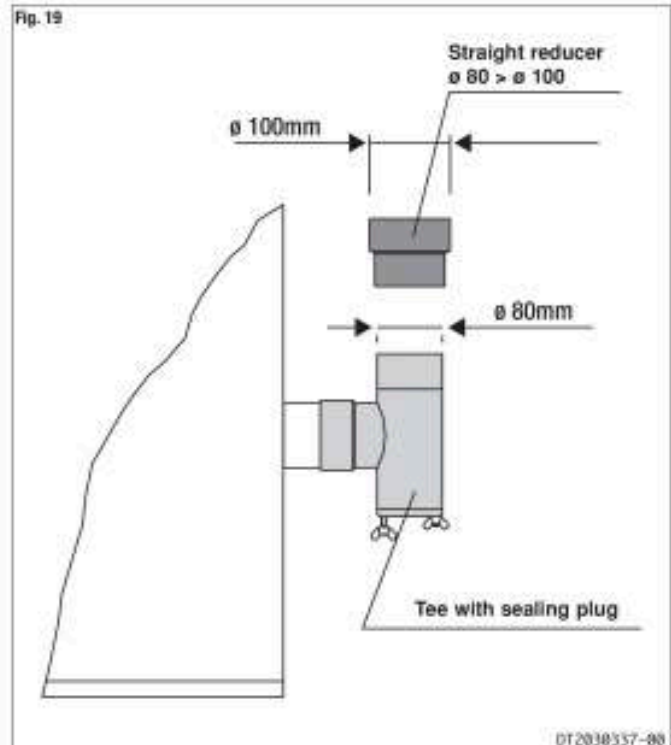

1.10 Connecting to a conventional chimney - Fig. 21-22

If you wish to use an existing chimney it is strongly recommended that you have it checked by a professional chimneysweep to ensure that it is completely airtight. The reason for this is that the smoke, because it is slightly pressurised, can infiltrate any cracks in the flue and escape into living spaces. If upon inspection you find that the chimney is not completely sound, it is recommended that you insert piping made of new material. If the existing chimney is wide enough we recommend a pipe with a maximum diameter of 150mm. It is also recommended that you insulate the chimney flue (Fig. 21-22).

Pipes and bends made by Gruppo Piazzetta S.p.A. are recommended for connection to the flueway, since they are sized to fit the flue outlet of the appliance.

Other pipes may be applied after adaptation and checking of the compatibility of the coupling, taking into account that the pipes and bends must be made in compliance with current regulations. In this case, however, Gruppo Piazzetta S.p.A. only guarantees trouble-free operation for parts that it manufactures and that are used according to specifications.

Connection to the flue must respect the **40cm minimum safety distance** from heat-sensitive structural components or inflammable materials (wood panelling, beams or ceilings, etc). (See figures 17-18).

- If the connector has to pass through partitions or walls of inflammable or heat-sensitive materials, or through load-bearing walls, create: an insulating barrier equal to or greater than 10cm around the connector using mineral-based insulating material (rock wool, ceramic fibre) with a nominal density greater than 80kg/m³.
- If the connector has to pass through non-flammable partitions or walls, create: an insulating barrier equal to or greater than 5cm around the connector using mineral-based insulating material (rock wool, ceramic fibre) with a nominal density greater than 80kg/m³.
- Check that the connection to the flueway is gas/smoke-tight, since the appliance operates in a vacuum.
- Check that the pipe does not penetrate too far into the flueway, thereby choking the pipe for the passage of smoke and combustion gases.

 **Ensure that all installation work is carried out to professional standards.**

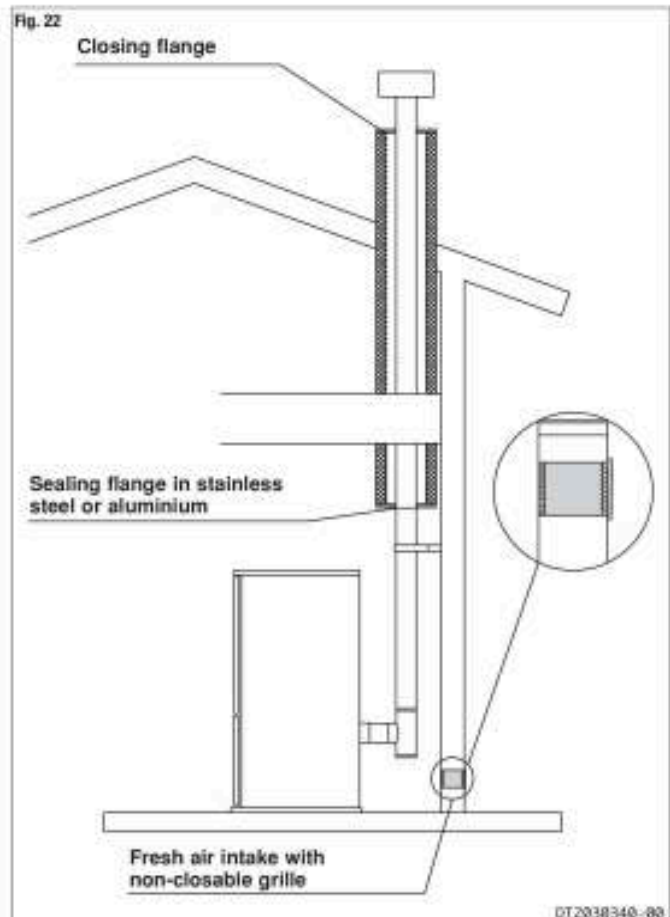
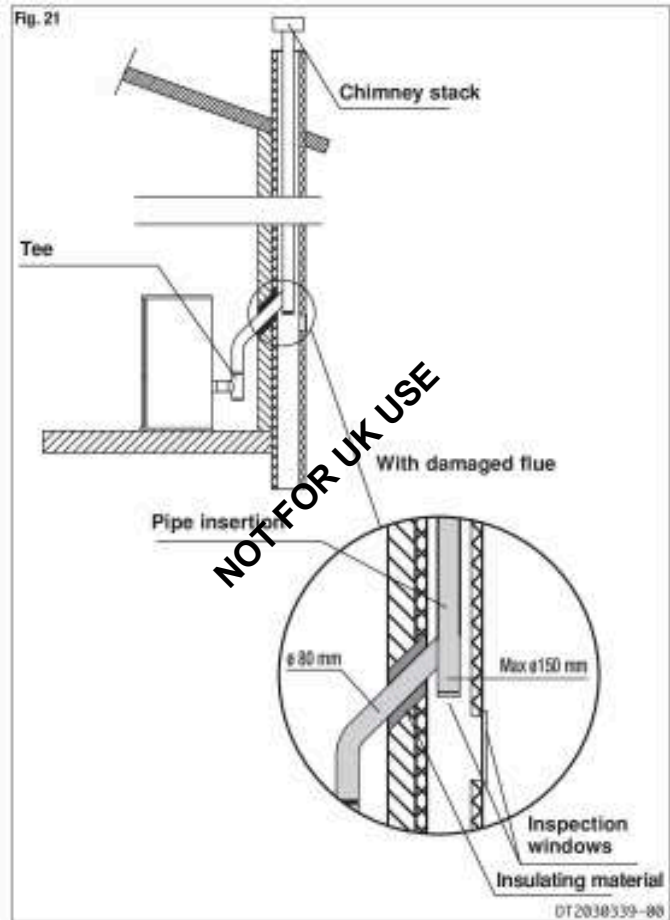

1.11 Using an external flue - Fig. 23

An external flue can be used provided it complies with the following requirements:

- use only insulated stainless steel pipes (double-lined) fixed to the outside wall of the building (Fig. 23);
- there must be an inspection opening at the base of the flue to permit periodic checks and maintenance;
- the flue must be fitted at the top with a chimney stack with down-draught cowl, also ensuring compliance with the safety distance from the roof ridge as outlined in the section entitled

⚠ Ensure that all installation work is carried out to professional standards.

1.12 Prevention of domestic fires

The product must be installed and used in compliance with the manufacturer's instructions and European and national standards as well as local regulations.

⚠ when a flue pipe passes through a wall or a ceiling, special installation methods must be applied (protection, thermal insulation, distances from heat-sensitive materials, etc.) See the paragraph "Connection to the flueway"

- It is also recommended that all elements made of combustible or inflammable material, such as beams, wooden furniture, curtaining, flammable liquids, etc. be kept outside the heat radiation range of the stove and in any case at a distance of at least 1m from the heating block.
- For other information, see the paragraph "**Safety distances**" and "**Connection to the flueway**".
- The flue pipe, chimney stack, chimney and fresh air intake must always be free of obstructions, clean and checked periodically, that is, at least twice during the seasonal period from the lighting of the stove and during its use. When the stove has not been used for some time it is advisable to carry out the checks mentioned above. For further information, consult a chimneysweep.
- Only use recommended fuels (See paragraph "**Fuels**").

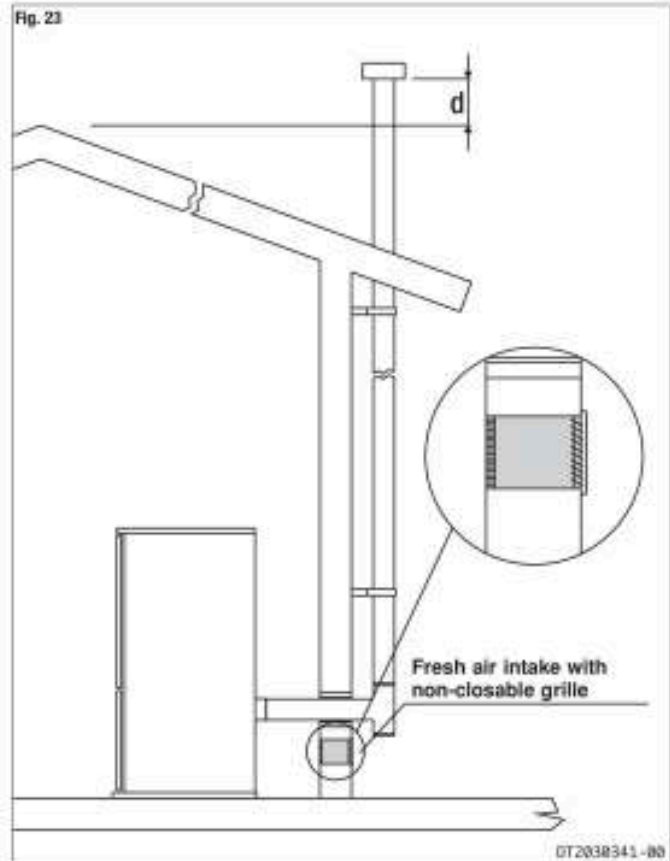

2.1 Characteristics

Fuel:	<ul style="list-style-type: none"> • Natural wood pellets • Length: < 30mm • Diameter: ca. 6 - 6.5 mm • Moisture content: ca. 6% - 8%
-------	--

2.2 Technical data

	UNIT	P950	P955	P956
Hourly fuel consumption (max/min)	kg/h	1,5 / 0,75	1,9 / 0,75	1,9 / 0,75
Nominal thermal power (max/min)	kW	6 / 2,5	8 / 2,5	8 / 2,5
Efficiency	%	> 80	> 80	> 80
Draught when connected to chimney	Pa	10÷15	10÷15	10÷15
Hopper capacity	kg / (l)	16 / (24,5)	18 / (27,5)	26 / (40)
Electrical power supply	V	230	230	230
Frequency	Hz	50	50	50
Frequency only for Japan	Hz	60	60	60
Maximum input	W	330	330	330
Power rating (max / min)	W	90 / 70	90 / 70	90 / 70
Flue gas outlet diameter	cm	Ø 8	Ø 8	Ø 8
Fresh air intake with minimum useful section	cm ²	100	100	100
Weight of stove with cladding	kg	121	160	160
Weight of stove with packaging	kg	140	180	180
Pack sizes (DxWxH)	cm	59x54x122	68x68x129	68x68x129

Data obtained under laboratory conditions with pellets giving heat output of 5kWh/kg

2.3 Product identification data

The rating plate gives the data and ratings of the appliance.

If the rating plate is missing, has been removed or tampered with, any installation and maintenance operations are made difficult due to lack of product identification.

In the event of damage, please ask the Piazzetta after-sales service centre for a copy.



2.4 Plan P960 (cm)

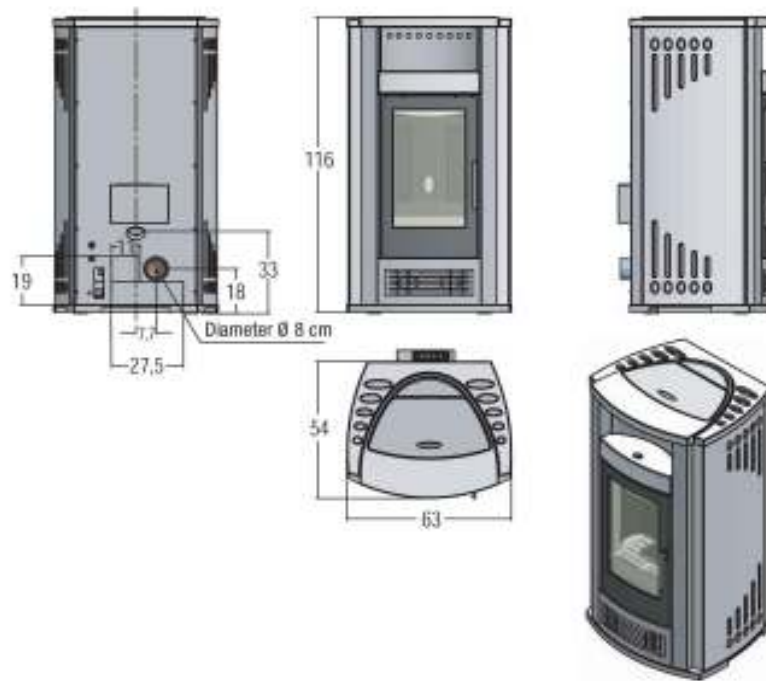

DT2038607-00

2.5 Plan P960 F (cm)

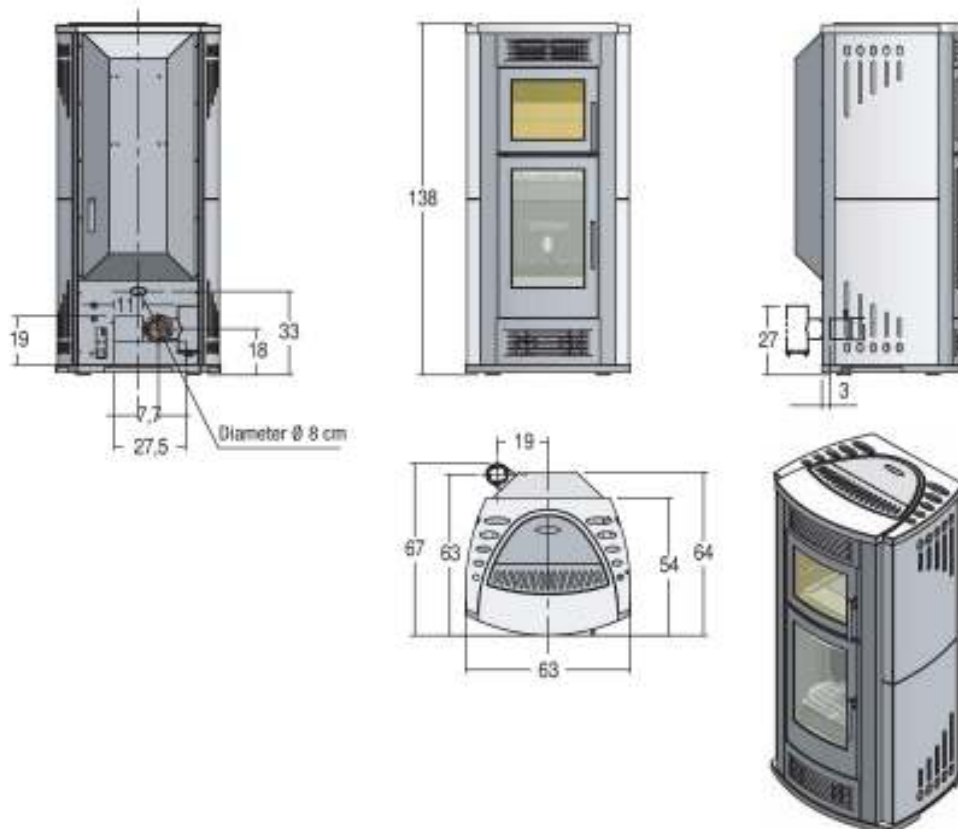

DT2038655-00

2.6 Plan P961 (cm)

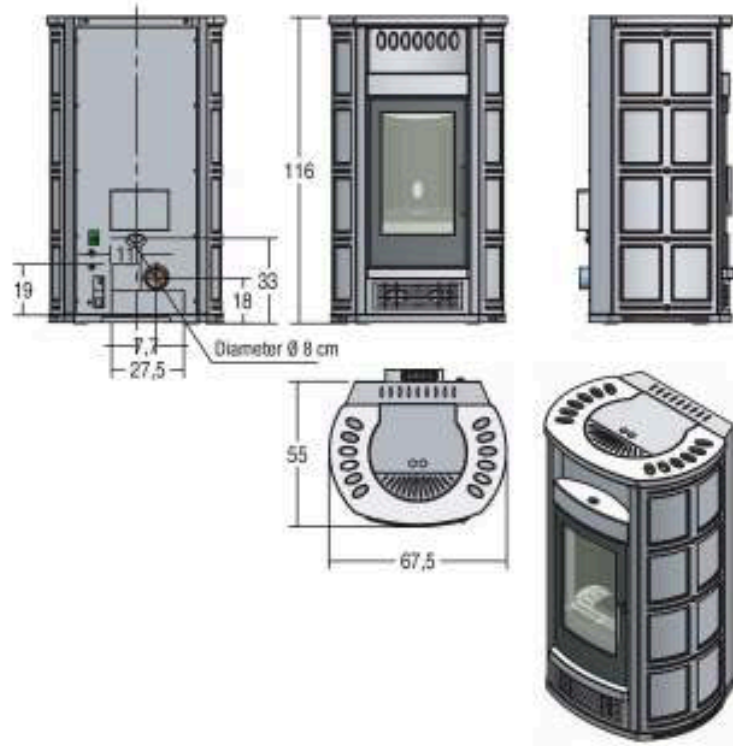

DT 2030355-00

2.7 Electrical diagram P960 F

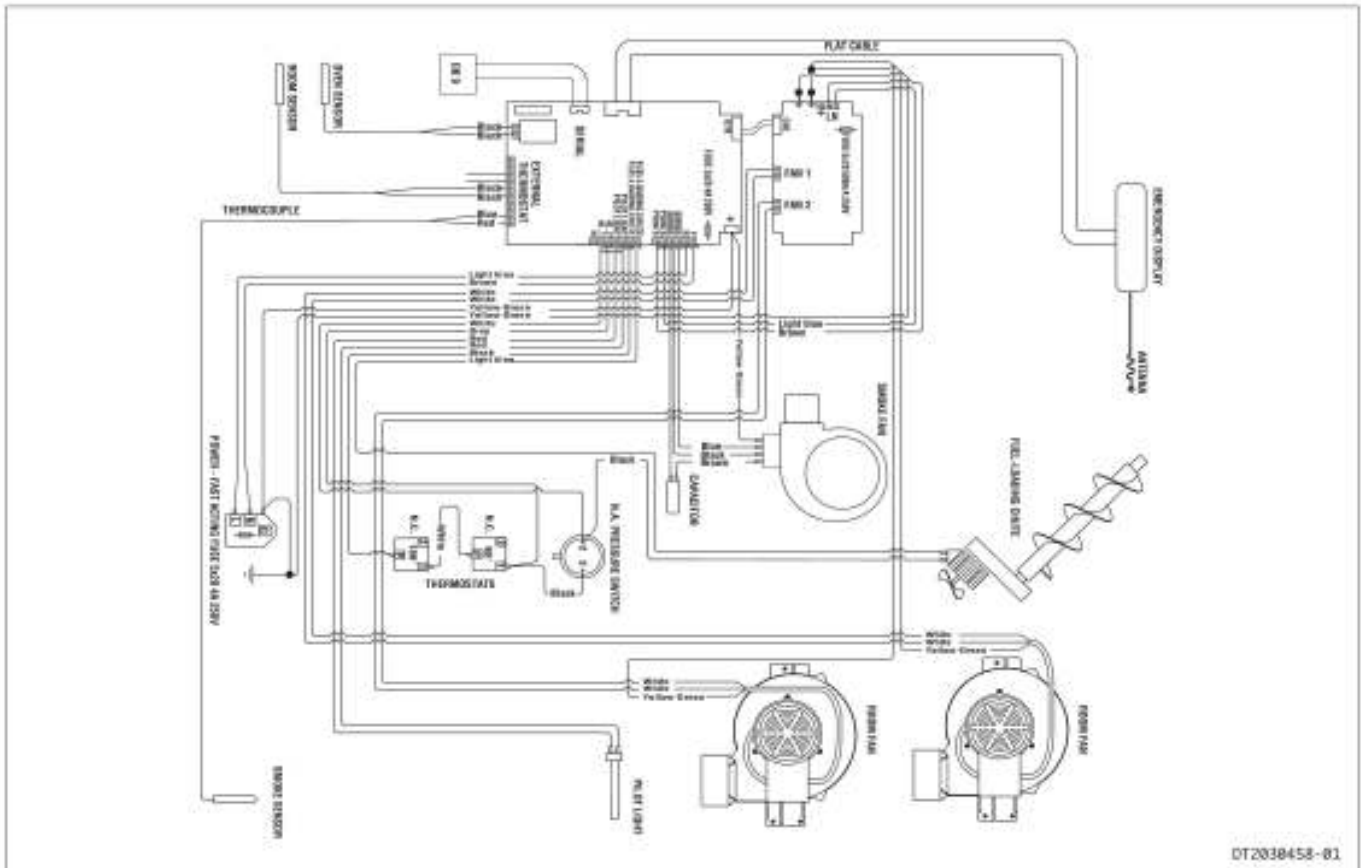

2.8 Electrical diagram P960 - P961

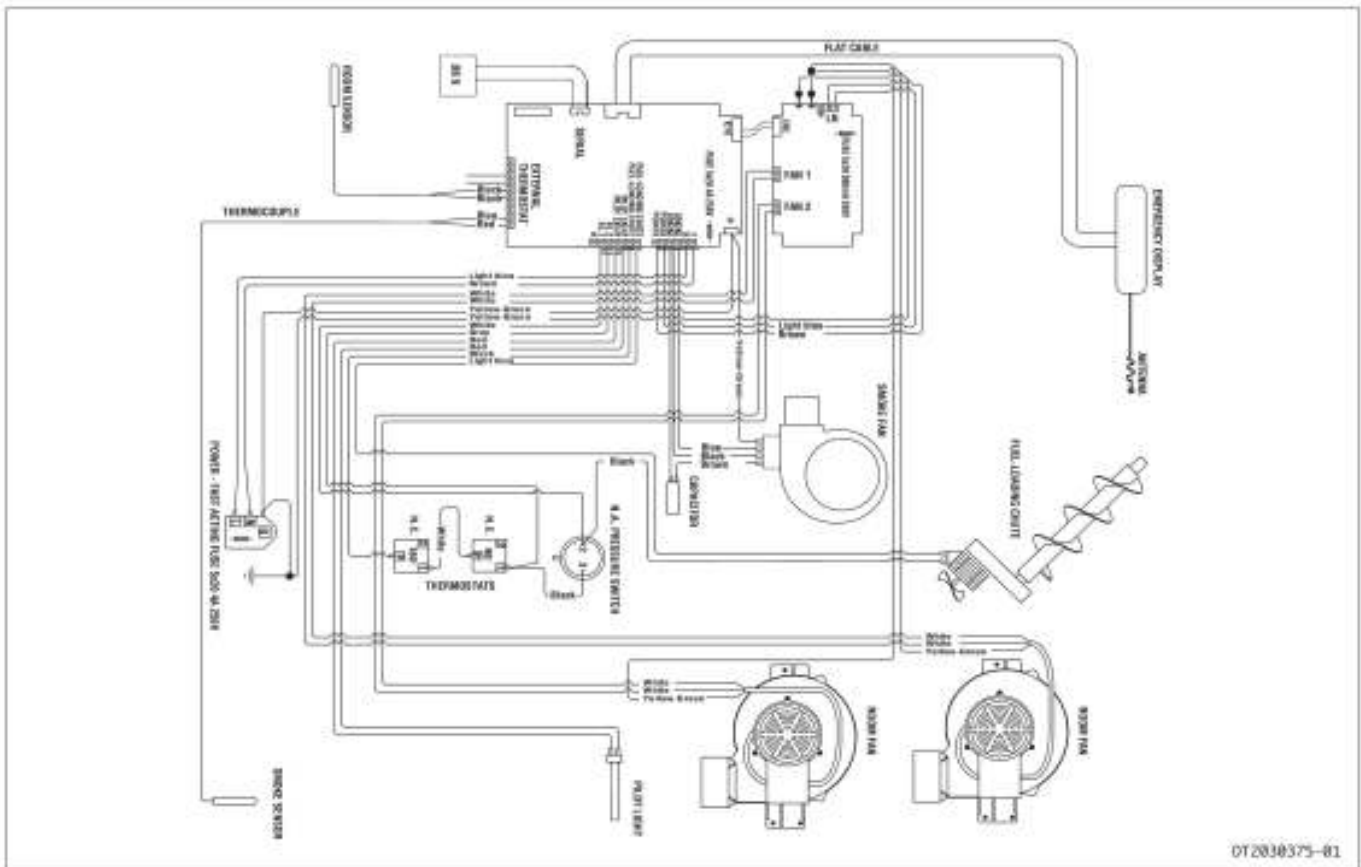

The pellet stove has been designed to burn only wood in pellet form.

The wood pellet is obtained by pressing wood sawdust left over from the working of natural dried wood. The typical small, cylindrical form is obtained by a process similar to wire-drawing. Thanks to lignin, a natural element which is released during the pressing of the raw material, the pellets acquire a good consistency and compactness without requiring treatment with additives or caking agents.

There are various types of pellet on the market with qualities and characteristics that vary depending on the processes they have undergone and the type of wood used in their production.

Since the characteristics and quality of the pellet considerably affect stove performance, efficiency and proper operation, we recommend that you USE high-quality pellets.

Gruppo Piazzetta S.p.A has tested and programmed its stoves and can promise optimum performance and trouble-free operation using pellets with the following specific characteristics:

- Material: wood
- Length: not greater than 30mm
- Diameter: 6-6.5mm
- Net heat value: 5kWh/kg
- Moisture content: not greater than 8%
- Residual ash: 0.34%

To ensure trouble-free operation:

DO NOT use pellets with dimensions other than those stipulated by the manufacturer

DO NOT use pellets which are out of date or which contain loose sawdust, resins, chemical substances, additives or caking agents.

DO NOT use damp pellets.

Choosing other and unsuitable pellets:

- obstructs the grate and flue gas pipes
- increases fuel consumption
- reduces efficiency
- means that proper stove operation cannot be guaranteed
- causes dirt to build up on the glass
- leaves particles which have failed to burn and heavy cinders

The presence of moisture in the pellets increases their volume and causes them to split which in turn causes:

- malfunction of the fuel-loading system
- inefficient combustion

Pellets should be stored in a sheltered, dry place.

To use good-quality pellets with other dimensions and heat-producing properties than those recommended above, you will need to alter the operating parameters of the stove. This "customisation" of stove settings must be carried out at a Gruppo Piazzetta S.p.A. Service Centre or by specially qualified personnel authorised by Gruppo Piazzetta S.p.A.

⚠ Using pellets that are out of date or not in conformity with the manufacturer's recommendations not only damages the stove and jeopardises performance, but can render the guarantee null and void and relieves the manufacturer of all liability.



4.0 PREPARING FOR INSTALLATION

During operation some parts of the stove (door, handle, controls, ceramic parts) can reach high temperatures. Take great care and all the necessary precautions, especially in the presence of children, the elderly or disabled and pets.

To prevent accidents or damage to the product we recommend the following:

- unpacking and installation must be carried out by at least two people;
- every operation involving movement of the product must be carried out with the proper tools in full compliance with current safety regulations;
- the packaged product must be kept in the position according to the directions shown by the diagrams and notices on the pack;
- if ropes, straps or chains are used, ensure that they are able to take the weight of the pack and that they are in good condition;

- use slow continuous movements when moving the pack to avoid jerking the ropes, chains, etc.;
- do not tilt the package excessively to avoid toppling;
- never stand in the vicinity of loading/unloading equipment (forklift trucks, cranes etc).

⚠ Before installing the product make sure that you have the correct equipment.

Unpack the product being careful not to damage or scratch it, take the accessories pack and any pieces of polystyrene or cardboard used to wedge moveable parts etc. out of the stove firebox.

Keep packaging (plastic bags, polystyrene, etc.) out of reach of children, since it could be a potential source of danger, and dispose of according to local regulations.

Pursuant to current regulations on the safety of electrical equipment, you must contact a Piazzetta After-Sales Service Centre or a qualified electrician for all and any work connected with installation, maintenance or servicing that involves access to electrical parts.

External pressure switch

- The stove is fitted with an external pipe tap for measuring the pressure (vacuum) in the flue gas outlet pipe. Authorised personnel should carry out this verification and control whilst the stove is being installed.

5.1 Multifuoco system - Fig. 25 / 27

- Piazzetta's technological research and development mean that this pellet stove offers the advantages of the 'Multifuoco' system, a system exclusive to and patented by Gruppo Piazzetta S.p.A., a true innovation in the field of pellet stoves.

- The 'Multifuoco' system revolutionises all methods of heat circulation currently in use in pellet stoves: the heat produced by the furnace is circulated into the atmosphere not only from the base of the stove itself, it can also be directed via 75mm-diameter flexible pipes to adjoining rooms (fig 26).

This exclusive heat distribution system offers many notable advantages: even spread of temperatures; heating adjoining rooms.

The heat produced is propelled by a fan and distributed via the outlet at the back of the stove.

- The front grill is equipped with two deflectors (fig 27) to change the direction of the heat current as it exits the front of the stove. To deflect the heat current in the desired direction simply adjust the angle of the deflectors (fig 30) using the lever provided (fig 29).

⚠ When the stove is lit, use the glove provided to carry out this operation.

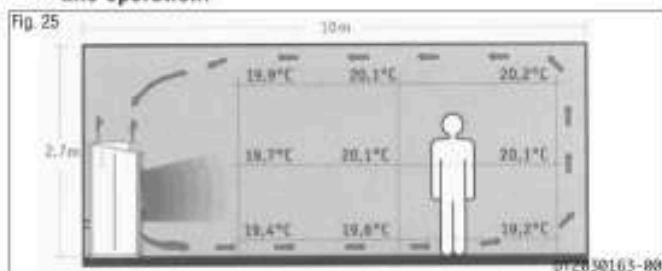

Cladding

- Having completed assembly of the stove and installed any external room thermostat, proceed with assembly of the stove cladding, referring to the ceramic cladding instruction booklet provided with the stove.

DT2010071-01

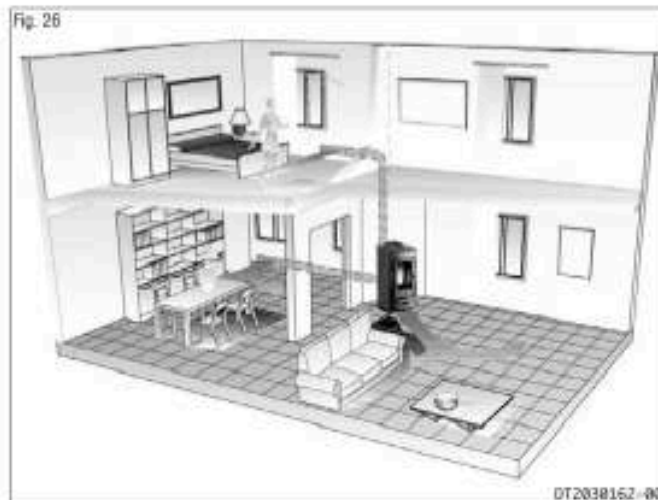

Instructions for redirecting heat

- The fan system which expels heat into the atmosphere is equipped with two Y-shaped devices which effectively allow the air flow to be doubled up, directing it via a flexible pipe to the back of the stove from where it can then be directed into adjoining rooms.
- Below are some examples of possible installations and examples of how to redirect the hot air in order to heat other rooms. Such examples are intended as demonstrations; optimum performance depends in each case on conditions in the room where the stove is installed and in the adjoining rooms.

⚠ It is of fundamental importance that when redirecting heat from the rear of the stove the outlets and the Y-connector are free of blockages to avoid overheating. In cases where one rear outlet from the fan is to be employed, the outlet must always be kept open.

- The examples give guidelines for redirection. Each diagram represents only one solution of the many possible.

SOLUTION 1 - Fig. 31 - 32:

- the stove is installed in the room which is to be heated, with the heat directed to the front only, as when the stove arrives from the factory (fig 31). Alternatively the air can flow to the rear by connecting a 7.5cm-diameter flexible pipe to the fan (fig 32). In this scenario the stove heats the room where it is installed by radiation only, and heats the adjoining room by means of redirection to the rear.

⚠ For the example shown in fig 32 it is necessary to use an outlet which is permanently open.

SOLUTION 2 - Fig.33:

- The stove is installed in the room to be heated with the heat directed to the front by one fan. A second fan directs to the rear allowing the heating of a second room. A 7.5cm-diameter flexible pipe with a maximum length of 6 metres is connected to the fan's outlet (fig 33).

⚠ For the example shown in fig 33 the vent should be permanently open.

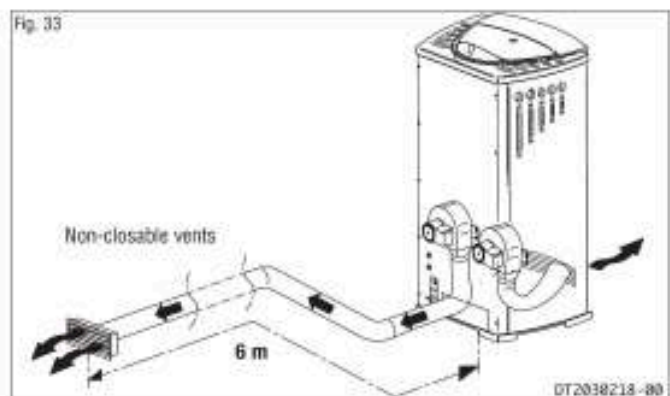
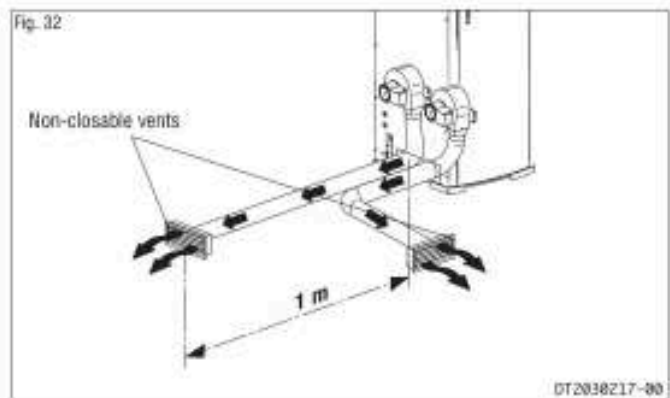
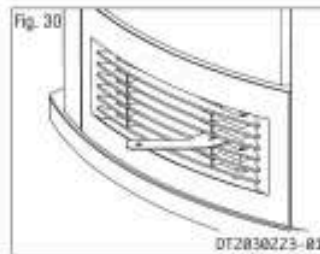
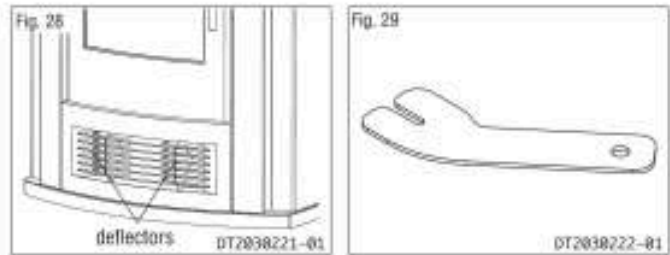

SOLUTION 3 - Fig. 34:

- The stove is installed in the room to be heated with the heat channelled in three directions. One fan propels heat to both front and rear of the stove via the Ydevice and a length of flexible pipe of diameter 7.5cm. The output of the second fan is directed to the rear only via a flexible pipe of diameter 7.5cm and maximum length 6 metres (fig 34).

⚠ For the example shown in fig 34 the vent at the end of the single redirection should be permanently open.

SOLUTION 4 - Fig. 35:

- Extending the previous solution, with the stove installed in the room to be heated and the heat directed as in SOLUTION 3, with the outlet from one fan doubled using a second Y connector at the rear as shown. Use 7.5cm-diameter flexible pipe with a maximum total length of 6 meters (fig 35).

⚠ For the example shown in fig 35, for the redirection to function correctly and to avoid overheating, it is necessary to use non-closable vents as shown. During operation the vent closest to the stove should be partially open but never closed to avoid overheating.

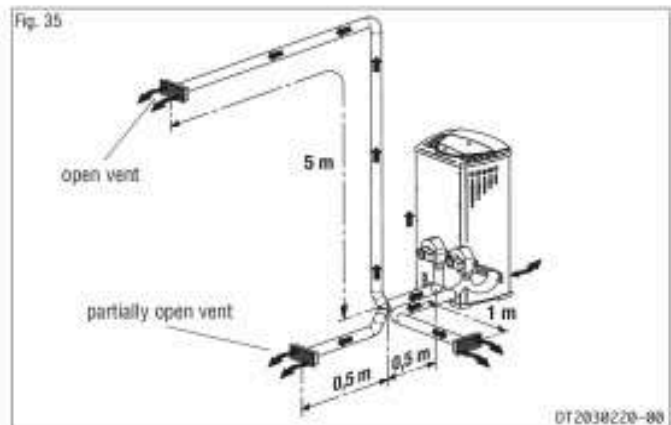
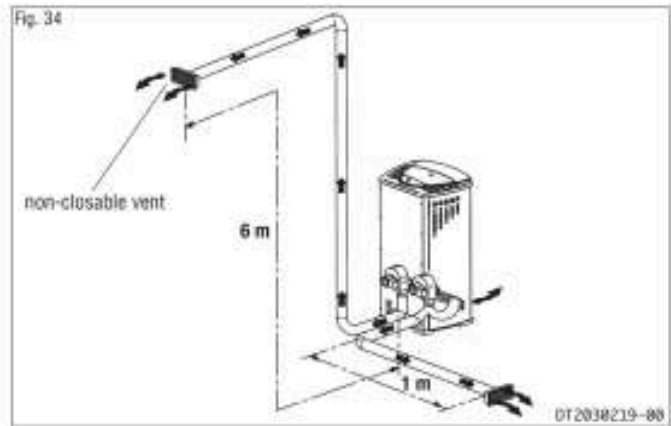

Ducting through walls or floors - Fig. 36 / 39

To ensure efficient ducted heat distribution:

- 1) lag the pipe with insulating material to limit heat loss and ensure a sufficiently high air temperature;
- 2) do not exceed the total maximum hose length of 4.5 m.

Below are some examples of how the hose can be installed in walls or floors (for better performance, lag the hose with suitable insulating material).

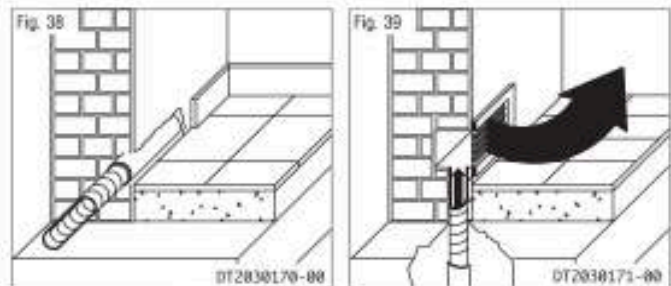
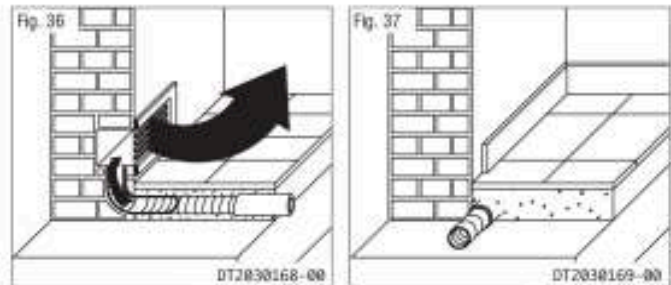

Hot air outlet vent radiation area (mm) - Fig. 40

A safety area must be ensured around the hot air outlet vent within which there must be no flammable objects (furniture, carpets, curtains, etc.) or heat sensitive materials (wood, plastic, etc.).

The diagram to the side shows the measurements for this safety area, which includes 600mm from the upper edge of the vent.

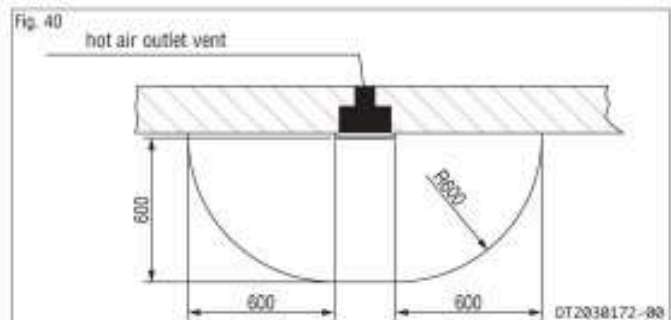

5.2 Electrical connection and the room sensor connection - Fig. 41 / 43

- The stove comes with a power cable which must be connected to a 230v/50Hz (230V/60Hz only for Japan) supply. Connection to the rear of the stove is shown in fig. 41.
- The power rating is indicated in the paragraph "Technical data" in this booklet.
- According to law the installation must be earthed and include a residual current circuit breaker.
- Ensure that in its normal position the power cable does not come into contact with any heated parts.

⚠ Ensure that the electrical socket is accessible also after installation of the stove.

- When installing the stove, it is necessary to connect the room sensor (provided) in the correct socket (fig. 41). The sensor can be positioned as shown in fig. 42-43, otherwise remove the band and uncoil the lead and then place the sensor in a spot where a more accurate room temperature reading can be obtained.

5.3 Installing the external thermostat - Fig. 41, 44 / 47

- To connect the external thermostat use cable type 2x0.5mm² stopped with a PG7 connector to be inserted in the appropriate socket in the rear panel (fig 41). **This operation should be carried out by authorised personnel.**

⚠ Installation can be carried out with any type of thermostat but requires connector PG7 similar to that shown in fig 44. To connect the thermostat to the electronic board, refer to the electrical diagram.

- Remove the electronic board's protective panel (fig 46).
- Stop the thermostat cable with connector PG7 and insert this in the socket at the rear (fig 45).
- Finally connect the thermostat's terminal to the two-pin terminal of the electronic board (fig 47).
- Replace the electronic board's protective panel.

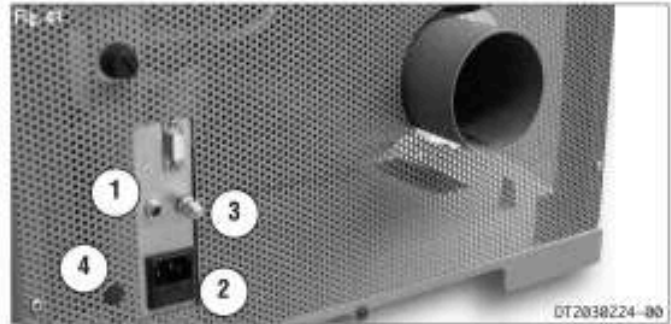

- 1 External socket for connection of temperature sensor
- 2 Socket for power lead
- 3 External pressure socket
- 4 Socket for inserting cable PG7 for connection of external thermostat
- 5 Connecting the temperature sensor
- 6 Connecting the power cable

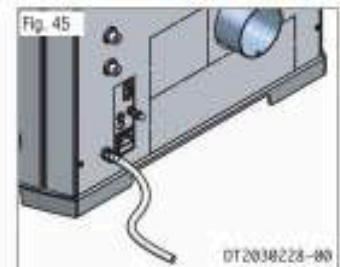
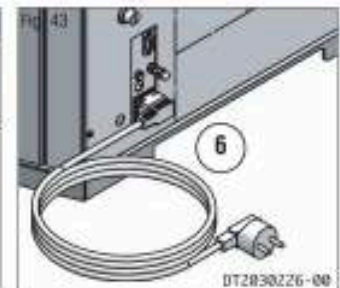
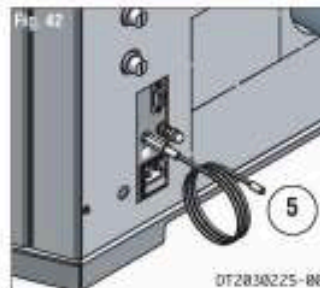

- 1 Thermostat
- 2 Electronic board 2-pin terminal
- 3 Connector
- 4 Thermostat cable terminal



5.4 Installing the Y connector (optional) - Fig. 48 / 56

- The redirection of heat to adjoining rooms is at the user's discretion.
- The Y-connector can be attached to either fan.
- You can choose to use only one of the fans' outlets to heat adjoining rooms, in which case it is more convenient to use the right fan. Proceed as follows:

⚠ For convenience, the following assembly operations should be carried out during the installation phase first on the left fan (as viewed from the rear) and then on the right fan (fig 48).

1. Take off the stove's back panel
2. Uncoil the flexible pipe from the fan's outlet by unscrewing the clip which holds it in place.
3. Cut around 5cm of flexible pipe (fig 49).
4. Fix the flexible pipe to the Y-connector using the clip provided (fig 50).
5. Fix the Y-connector to the fan's outlet using the screws provided (fig 51). (for the left fan see fig 53)
6. Attach the second flexible pipe to the Y connector using the clip provided (fig 52).
7. Repeat stages 2 - 6 for the right fan.
8. Take off the sub-section of the back panel (fig 54).
9. Replace the back panel.
10. Move the stove closer to the wall (fig 54) and, using the clips provided, fix the two flexible pipes to the pipes in the wall (fig 56).
11. Place the stove in the desired location, respecting the minimum safety distances (see section 1.8).

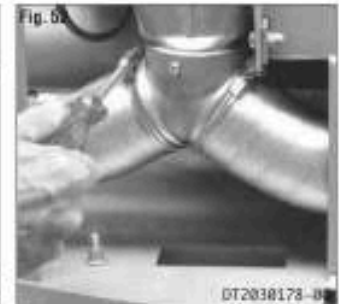

- Do not use the stove as a cooking appliance, except for the P 960 F.
- Ensure that the room in which the stove is installed is sufficiently well ventilated (fresh air intake).
- Ensure that all joints in the flue are hermetically sealed using a silicone- (not cement-) based sealant which is resistant to temperatures of up to 250°C and which shows no sign of deterioration.
- Check (or have checked) regularly that the flue is clean.
- Under no circumstances use fuels other than pellets.
- Remove any deposits of unused pellets left by failed ignition before restarting the stove.

⚠ Keep any inflammable object well away from the stove while it is in use (MINIMUM 80 cm from the front panel).

⚠ While in use the door must remain closed and the glass must be present and intact.

The removal of the protective grille inside the pellet hopper is strictly prohibited.

If replenishing with pellets while the stove is lit, ensure that the bag does not come into contact with any hot surfaces

DT2010035-01

6.1 Loading the pellets - Fig. 51 - 52

- To load the pellets into the hopper it is advisable to tear off the edge of the sack and empty the sack directly into the hopper. This makes filling easier and avoids pouring pellets on top of the stove.

⚠ Do not leave leftover pellets on top of the stove - they could catch fire!

6.2 Remote control - Fig. 53

- The pellet stove comes equipped with an LCD-display remote control and radio transmitter which allow you to operate its various functions.

⚠ The remote's range can be affected by other devices which operate on a continuous radio frequency of 433.92 MHz , for example radio headphones, toys, wireless mouses etc.
The remote has a range of around seven metres in conditions where there is no interference from other sources.

- When pressing the keys to select the various functions wait for a signal from the stove that the selection has registered before selecting further functions. Or if you are in an adjoining room wait for confirmation on the remote's display. If the stove is not receiving signals from the remote try bringing the remote closer to the stove. Below are listed the various functions of the remote control's keys.

Fig. 51



DT2030459-00

Fig. 52



DT2030468-00

Fig. 53

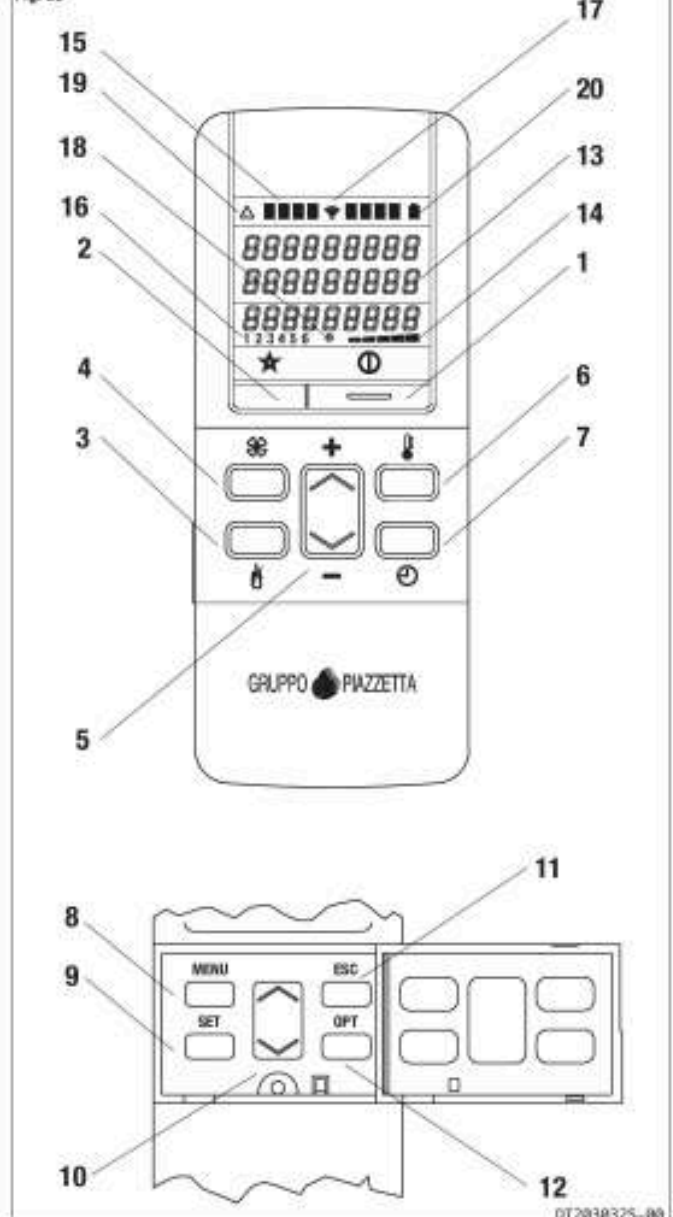

DT2030325-00

NUMBER	KEY / DISPLAY	DESCRIPTION
1	KEY ON/OFF	Allows you to start up or shut down the stove.
2	KEY STAND-BY	Pressing the stand-by key and holding it down (for around 5 seconds) until KEYPAD BLOCKED appears on the display will disable the keypad. To re-enable the keypad press the stand-by key and hold it down (for around 8 seconds) until KEYPAD UNBLOCKED appears on the display.
3	KEY POWER	Allows you to select the power setting. With the SELECT key you can choose between the four available settings, P1-P2-P3-P4.
4	KEY FAN SPEED	Allows you to choose the speed setting on the Multifuoco fan. With the SELECT key you can choose between the three available settings, 1-2-3.
5	KEY SELECT	Allows you to choose: <ul style="list-style-type: none"> • power level - having previously pressed the POWER key • fan speed - having previously pressed the FAN SPEED key • temperature - having previously selected the TEMPERATURE key.
6	KEY TEMPERATURE	Allows you to set the room temperature. The SELECT key will allow to choose the desired temperature between 7°C and 30°C.
7	KEY TIMER	Displays the current date and time.
8	KEY MENU	Allows: <ul style="list-style-type: none"> • access to the programming menu • return to the initial display.
9	KEY SET	Confirm MENU selected
10	KEY MENU SELECTION	Scrolls through the programming MENU
11	KEY ESC	Returns to previous menu
12	KEY OPT	Displays the MULTICOMFORT temperatures. The dash before the temperature shows which sensor is giving the temperature reading.
13	DISPLAY	Shows on three lines the function settings, the current time and the temperature.
14	DISPLAY POWER	Shows the power setting selected, P1-P2-P3-P4.
15	DISPLAY MULTIFUOCO	Shows the Multifuoco setting selected, 1-2-3.
16	DISPLAY DAYS OF THE WEEK	Shows the day of the week, 1 Monday, 2 Tuesday, 3 Wednesday, 4 Thursday, 5 Friday, 6 Saturday, 7 Sunday.
17	DISPLAY RADIO SIGNAL EMISSION	Active if the remote is receiving data from the stove
18	DISPLAY TIMER	Shows that the timer is engaged
19	DISPLAY SAFETY	Symbol appears when the safety system is activated
20	DISPLAY FLAT BATTERY	Shows that the battery is flat

6.3 Lighting for the first time

- Before lighting the stove, check that the grate is correctly inserted and pushed towards the left.
- When lighting the stove for the first time or when it has not been used for some time, it is advisable not to operate the stove at full power immediately. For the first few days, operation at medium power is recommended to allow all materials and mechanical parts to settle. Upon first ignition certain odours may be given off due to the evaporation of paint or grease. To alleviate the problem just air the room. Do not remain in the room when there are odours, as the fumes may be harmful to people or pets.
- When the pellet hopper is loaded for the first time the loading auger has to fill up; during this period the pellets will not be fed into the firebox.

6.4 Startup and normal operation - Fig. 54

- Before proceeding with lighting the stove:







Ensure that the hearth door is well closed.

- Check that the pellet hopper is full or at least contains enough pellets for the stove to run for the desired period.
- When the stove is connected to the power supply but is not yet lit, the display will show the readout OFF and in the lower half the current time, the measured temperature and the previously set power and fan settings.

Fig. 54



STARTUP

<i>Action</i>	<i>Function</i>	<i>Display</i>
<p>Hold the on/off key down for several seconds</p>  	<p>A cycle starts with three phases which take the stove into the normal operating mode:</p>	
	<ul style="list-style-type: none"> • CONTROL first 20 seconds The extractor fan activates for a few seconds. 	
	<ul style="list-style-type: none"> • START PHASE I The fuel-loading chute is activated and starts to feed pellets into the burner (the LED on the display lights up at fixed time intervals). The pilot light ignites (the LED on the display lights up). The extractor fan starts up. 	
	<ul style="list-style-type: none"> • START PHASE II If the lighter has triggered the combustion process, the fuel-loading auger slows down to allow a period of stabilisation and correct combustion of the pellets in the subsequent normal operating mode. If during the startup phase the sensor on the flue gas outlet shows a rise in temperature (sign that the combustion process is underway), the stove is considered to be lit and goes into the normal operating mode. If during the startup phase the sensor on the flue gas outlet does NOT show a rise in temperature (sign that the combustion process is not underway), the stove should be considered off; a new ignition cycle will begin automatically and the three preceding phases will be repeated in succession. 	





DT2048851-8Z

FAILED IGNITION

<i>Action</i>	<i>Function</i>	<i>Display</i>
	<p>A second failed ignition is indicated on the display in the STOVE STATUS function by the readout "NO LIT" as well as the smoke sensor temperature, see "PROGRAMMING" paragraph. In addition a beep is emitted once every 5 seconds. This safety device is activated if the pellets do not ignite, if the pellet hopper is empty or if the temperature fails to rise.</p>	







DT2048856-8I





FAILED IGNITION: WHAT TO DO

Action	Function	Display
Shut the stove down by pressing the ON/OFF key down for several seconds. 	<ul style="list-style-type: none"> the alarm should stop; check the cause of the failed ignition. Always remove any fuel from the grate before starting a new ignition process. 	
Restart the stove by pressing the ON/OFF key. 	<ul style="list-style-type: none"> Repeat the ignition process as described above. 	
<p> If the appliance does not ignite properly the main cause could be either insufficient maintenance (consequently refer to the "Maintenance" paragraph) or the poor quality of the pellets (refer to the "Fuel" paragraph). It is therefore recommended to check these conditions before attempting to relight the appliance.</p>		

DT2048057-82

NORMAL OPERATION

Action	Function	Display
	Once the startup cycle has been completed successfully the stove stabilises in the normal operating mode.	
	The power, fan speed and room temperature may be adjusted during normal operation. To the side is an example of the INITIAL DISPLAY in normal operation.	
Press the POWER key  and to select 	POWER To adjust the power, press the POWER key and select the desired setting by pressing the SELECT key. After the desired setting has been selected the remote control returns to the INITIAL DISPLAY .	
Press the FAN key  and to select 	To adjust the Multifuoco setting, press the FAN key and select the desired Multifuoco setting using the SELECT key. On the P961 stove it is possible to adjust the two fans separately if SEPARATE FANS has been set in the fan mode menu. After having pressed the FAN key once (VENT 1 appears on the display) and selected the desired Multifuoco setting for the left fan, press the FAN key again (VENT 2 appears on the display) and select the desired Multifuoco setting for the right fan. After the desired Multifuoco setting has been selected the remote control returns to the INITIAL DISPLAY . To maximise the potential of the Multifuoco function read the paragraphs MULTIFUOCO AND MULTICONFORT OPERATION .	

Action	Function	Display
Press the TEMPERATURE key  and select 	<p>To adjust the temperature setting, press the TEMPERATURE key and select the desired temperature by using the SELECT key (range 7°C to 30°C). When the desired temperature has been reached the readout OK appears in the initial display and the stove operates at minimum power even if the display shows the originally set power level. The temperature can be read by the remote control, by the stove itself or by an external thermostat. To choose whether the remote or the stove will read the temperature see the section entitled PROGRAMMING, paragraph MULTICONFORT. If using an external thermostat the readout "ton" appears in the initial display and the readings from the stove and the remote control are cut out.</p>	
	<p>During normal operation the automatic grate cleaning function activates periodically, the frequency varying according to the settings pre-programmed by Gruppo Piazzetta personnel. This operation removes ash deposits and other buildups, which would otherwise prevent correct stove operation. The readout "PUL" appears in STOVE STATUS along with the flue gas temperature. See the Programming section.</p>	



DT2040052-01

EXTERNAL THERMOSTAT

Action	Function	Display
	<p>Stove operation can be regulated by any kind of external room thermostat connected to the electronic board. To connect the thermostat, see paragraph "Installing the external room thermostat".</p>	
	<p>Operation of the external thermostat depends on the stove temperature setting.</p> <ul style="list-style-type: none"> - If the set stove temperature is less than the room temperature, the external thermostat prevails. (It is advisable to set a minimum value of 7°C for the stove). - If the set stove temperature is more than the room temperature, the internal stove thermostat prevails. The external thermostat is disabled. <p> The room sensor must be connected. If the room sensor is not connected the appliance does not modulate the power and operates to user settings.</p>	

DT2040053-02

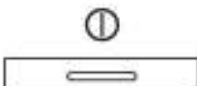
SHUTDOWN

Action	Function	Display
Hold the ON/OFF key down for several seconds 	Fuel loading stops, while the cooling fan and the extractor fan continue to operate for approx. another 10 minutes until the stove has cooled. The readout "PUL" appears in STOVE STATUS along with the flue gas temperature. See the section on programming.	
<p style="text-align: center;">⚠ Never unplug the stove from the power supply at this stage as this could cause internal problems and compromise subsequent ignition operations.</p> <p style="text-align: right;"><small>DT2048850-81</small></p>		

INTERRUPTION OF POWER SUPPLY

Action	Function	Display
	In the event of a brief interruption of the electrical current while the stove is in operation, the stove will restart automatically. <ul style="list-style-type: none"> • The grate cleaning phase activates. • The fan operates at full speed to allow the stove to cool. • The readout "PUL" appears in the STOVE STATUS mode. See the section on programming. • The automatic stove restart cycle begins (functions detailed in 'STARTUP' activate automatically). • Once the ignition cycle has been completed the stove operates normally at power level 2. • The stove will continue operating normally at power level 2. 	
<p style="text-align: right;"><small>DT2048861-81</small></p>		

6.5 Control panel - Fig. 55

The stove is fitted with a digital control panel to operate stove functions when the LCD remote control is unavailable. The various functions of the control panel are listed below.

Fig. 61



DT2038332-00

NUMBER	KEY / DISPLAY	DESCRIPTION
1	Key ON/OFF	Allows you to manually start up or shut down the product.
2	Led ON/OFF	The LED being lit indicates that the stove is lit.
3	Key INCREASE POWER	Allows you to increase the power setting. You can choose between the two available settings, P1-P3. The Multifuoco fan has a default setting for each of the two power settings.
4	Led INCREASE POWER	The LED lights up when the power-increase key is pressed and indicates that the increase has registered.
5	Key DECREASE POWER	Allows you to decrease the power setting. You can choose between the two available settings, P1-P3. The Multifuoco fan has a default setting for each of the two power settings.
6	Led DECREASE POWER	The LED lights up when the power-decrease key is pressed and indicates that the decrease has registered.
7	Led SAFETY	The led lighting up indicates that the safety system has been activated. After 60 seconds the alarm signal will sound. In the event of the safety system being activated proceed as follows: <ul style="list-style-type: none"> • Turn off the stove by holding the ON/OFF key down for several seconds. • The alarm signal will stop. • Wait until you are sure that combustion of any pellets left in the burner has ceased. • Wait for the stove to cool, then check for and remove whatever has activated the safety system. Finally, after having cleaned the burner, restart the stove by pressing the ON/OFF key.
8	Led RADIO SIGNAL EMISSION	The led lights up if the stove receives data from the remote control.

6.6 Setting the language

1. open the flap on the remote control;
2. press the "MENU" key;
3. scroll with the SELECT key "□" until "SELECT LANGUAGE" is displayed;
4. press the "SET" key;
5. scroll with the SELECT key "□" until the required language is displayed, e.g. "ENGLISH";
6. press the "SET" key to enter and confirm the required language.

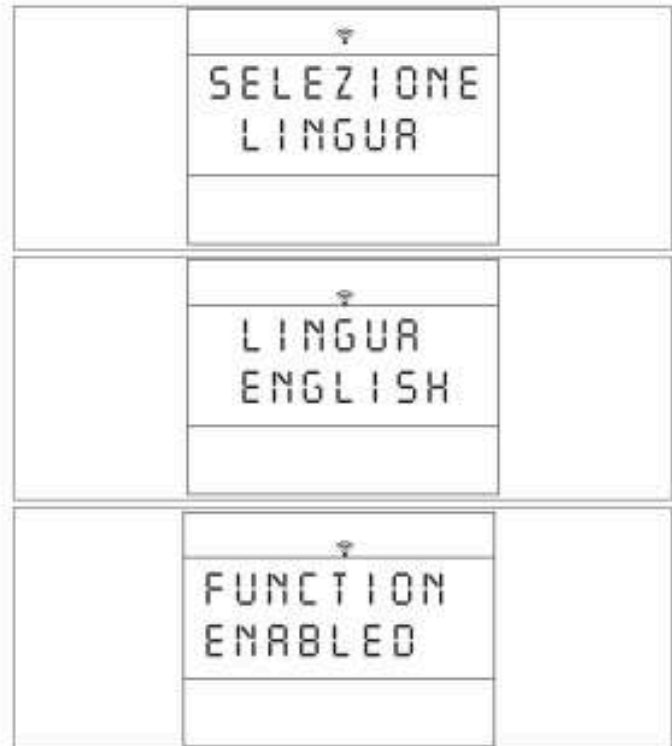

6.7 Mode of operation (stove P960 F only)

The "MENU" key can be used to set two different modes of operation of the stove.

STOVE mode

The stove is set for heating operation. The **STOVE mode** allows activation of the Multifluoco® system or Multicomfort® system (See paragraph, Programming P961).

OVEN mode

The **OVEN mode** setting is to be found only in the stove with oven (P960 F) and activates the ideal system for cooking food, which offers the possibility of setting the temperature and cooking time. See the paragraphs concerned with **OVEN mode** (Programming P960 F) for the settings.

In this mode all the set systems of Multifluoco® heating and the timer thermostat are automatically disabled. The stove automatically controls the power and the fan speed is at minimum.

⚠ To pass from the **STOVE MODE** (with medium-high power) to the **OVEN MODE** it is necessary to wait for the oven temperature to drop to the set cooking temperature. The oven may only be used after the buzzer has sounded and the writing "OK" has appeared on the display.

It is advisable to pass to the **OVEN MODE** when the stove is in the **STOVE MODE** at medium-low power.

⚠ If automatic lighting through the timer thermostat has been set, the stove must be turned off in the **STOVE mode**, otherwise automatic lighting will be impossible.

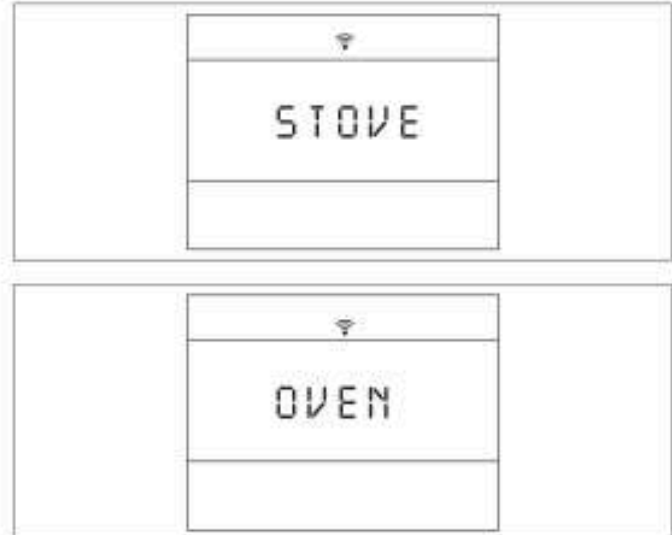

6.8 Programming P960 F



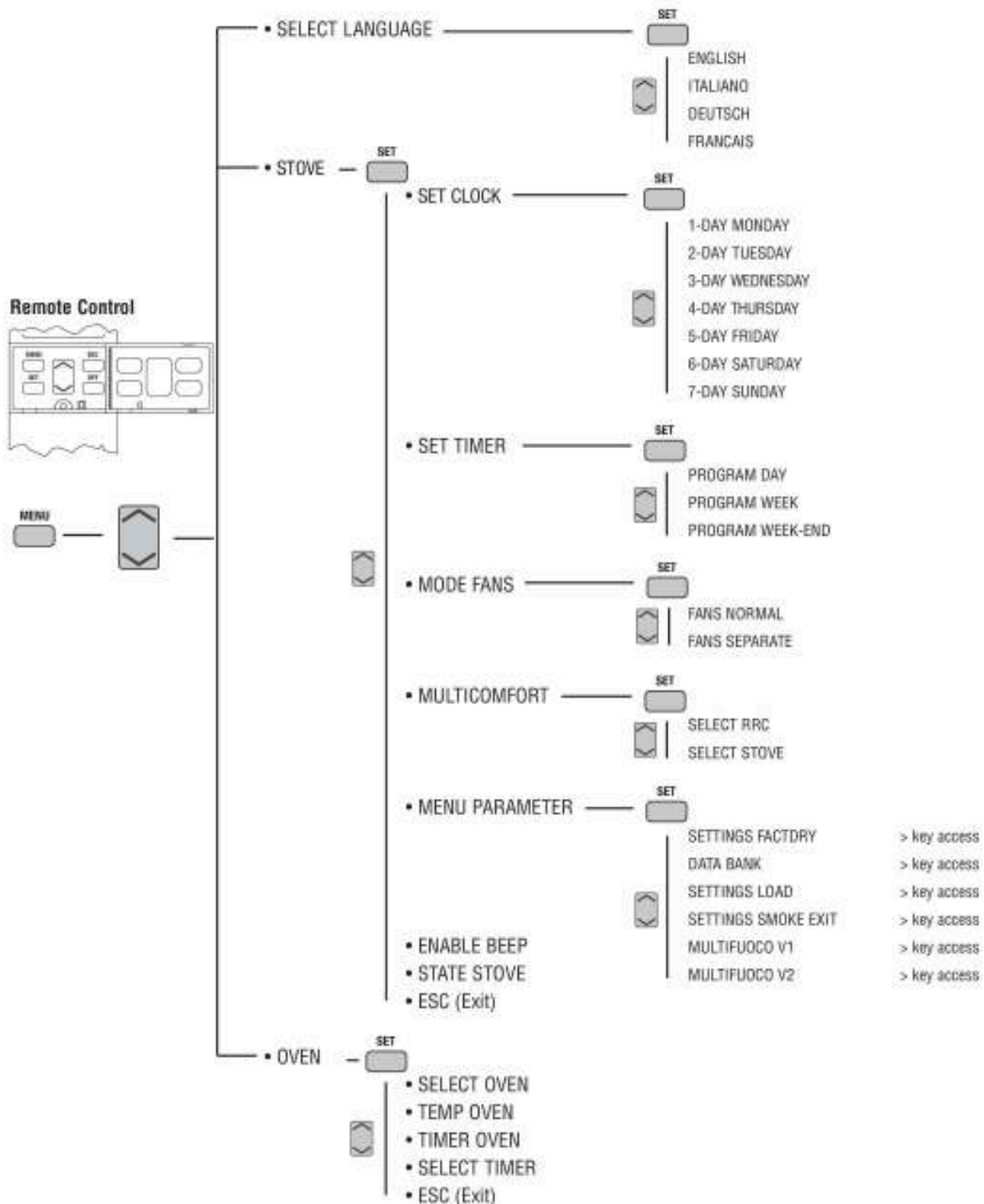





The remote control can be used to select the following functions from the main menu:



These functions are activated by opening the front flap and pressing the following keys:

- the MENU key is used to access the main menu and return to the initial display at any time during programming to alter data that has been input incorrectly.
- the MENU SELECTION key is used to scroll through the main menu and the submenus.
- the SET key is used to confirm a MENU or a selection.
- the ESC is used to return to the previous menu display at any time during programming to alter data that has been input incorrectly.

SET THE CLOCK (current day/time)





Function	Action	Display
Set the day	Press the MENU key, select the SET CLOCK menu using the SELECT MENU  key, then confirm by pressing the SET key.	
Confirm setting and move to next section.	Press the SELECT MENU  key and set the "day". Confirm by pressing the SET key.	
Set the hour.	Press the SELECT MENU  key and set the current "hour". Confirm by pressing the SET key.	
Set the minutes	Press the SELECT MENU  key and set the "minutes". Confirm by pressing the SET key. After confirmation the initial display will reappear.	

DT2048064-81

6.9 Stove Mode

In this STOVE MODE the stove is set for heating operation, thereby activating all the functions of the Multifuoco® or Multicomfort® system (See paragraph "Programming P960-P961").

How to set the stove mode:



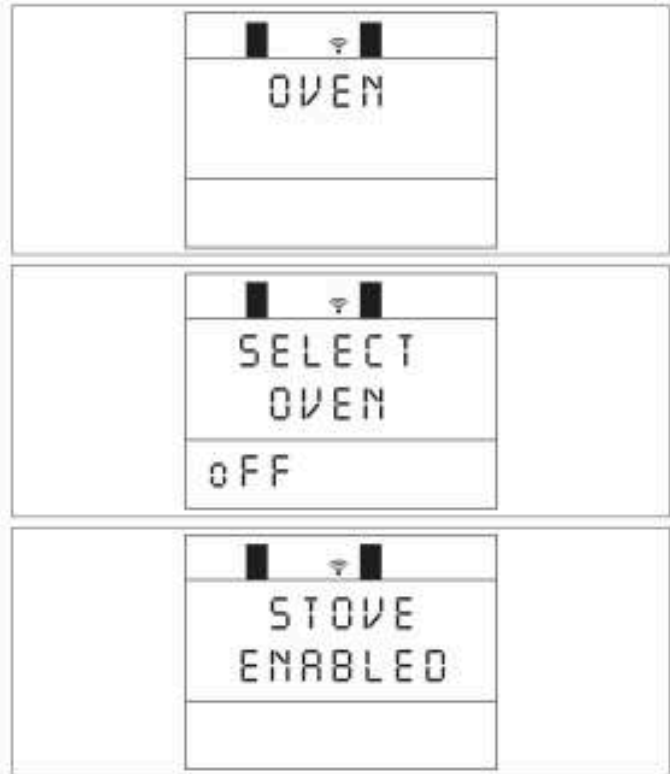

- 1) open the flap of the remote control;
- 2) press the MENU key;
- 3) set the mode **OVEN** by pressing the  or  key;
- 4) confirm using the SET key;
- 5) set **SELECT OVEN**;
- 6) confirm again using the SET key;
- 7) using the key  or , set "off" to deactivate the oven mode;
- 8) confirm using the SET key (STOVE ENABLED);
- 9) press the ESC key twice to exit from the menu.



6.10 Oven Mode

In the **OVEN** mode the stove is set for cooking operations.

How to set the oven mode:



- 1) open the flap of the remote control;
- 2) press the **MENU** key;
- 3) set the **OVEN** mode by pressing the key  or ;
- 4) confirm using the **SET** key;
- 5) set **SELECT OVEN**;
- 6) confirm again using the **SET** key;
- 7) with the key  or , set **on** to activate the oven mode;
- 8) confirm using the **SET** key (**OVEN ENABLED**);
- 9) press the **ESC** key twice to exit from the menu.

Press the **OPT** key to display the set functions.

 **The required function must be enabled each time by setting it to "on", otherwise it will be memorized only but not taken into consideration.**

In this mode the oven temperature **TEMP OVEN** is set. A buzzer sounds when the temperature has been reached and the writing "**OK**" appears on the display.







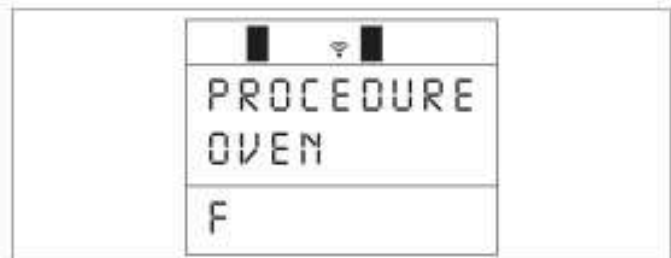
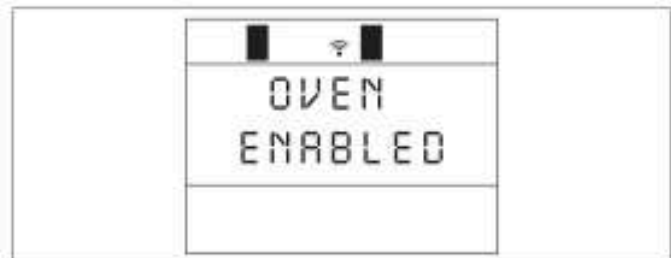

Once the required real oven temperature has been reached, an **TIMER OVEN** automatically activates with the required cooking time; when this set time has elapsed the writing "**GOOD**" appears on the display and a buzzer sounds.

The oven temperature **TEMP OVEN** or the cooking time **OVEN TIMER** may be reset at a later time; just enter the **MENU** parameters again and use the key  or  to go to the item to be changed (see paragraph "Programming P960 F").

 **A variation in colour tone of the stove is a natural characteristic of steel subjected to sharp temperature changes. This does not affect the quality of the product.**



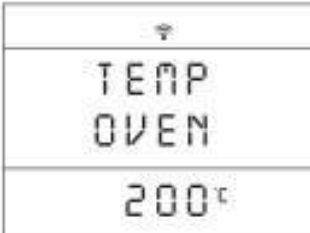











HOW TO SET THE OVEN TEMPERATURE

<i>Function</i>	<i>Action</i>	<i>Display</i>
	Open the remote control flap. Press the MENU key.	
Setting the OVEN mode	Use the key  to scroll the settings until OVEN . Confirm using the SET key.	
		
Setting the OVEN TEMP mode	Use the key  to scroll the settings until OVEN TEMP . Confirm using the SET key.	
Setting the temperature	Use the key  or  to set the required temperature anywhere between a minimum of 150°C and a maximum of 260°C. Confirm using the SET key.	
	 The appliance now automatically passes to the OVEN TIMER mode. To proceed with settings, see the table "HOW TO SET THE OVEN TIMER".	
Exiting from the MENU	Press the ESC key twice. The display returns to the display page OVEN MODE .	

DT2948874-88

HOW TO SET THE OVEN TIMER

Function	Action	Display
	Open the remote control flap. Press the MENU key.	
Setting the OVEN mode	Use the key  to scroll the settings until OVEN . Confirm using the SET key.	 OVEN
		 SELECT OVEN
Setting the OVEN TIMER mode	Use the key  to scroll the settings until OVEN TIMER . Confirm using the SET key.	 TIMER OVEN
Setting the temperature	Use the key  or  to set the required cooking time anywhere between a minimum of 1 minute and a maximum of 180 minutes. Confirm using the SET key.	 TIMER OVEN 30'
Activating the timer	Use the key  or  to activate with on or deactivate with off the oven timer. Confirm using the SET key.	 SELECT TIMER ON
Exiting from the MENU	Press the ESC key twice. The display returns to the display page OVEN MODE .	 TIMER ENABLED
		 PROCEDURE OVEN F T

DT2840875-08

6.11 Programming P960 - P961



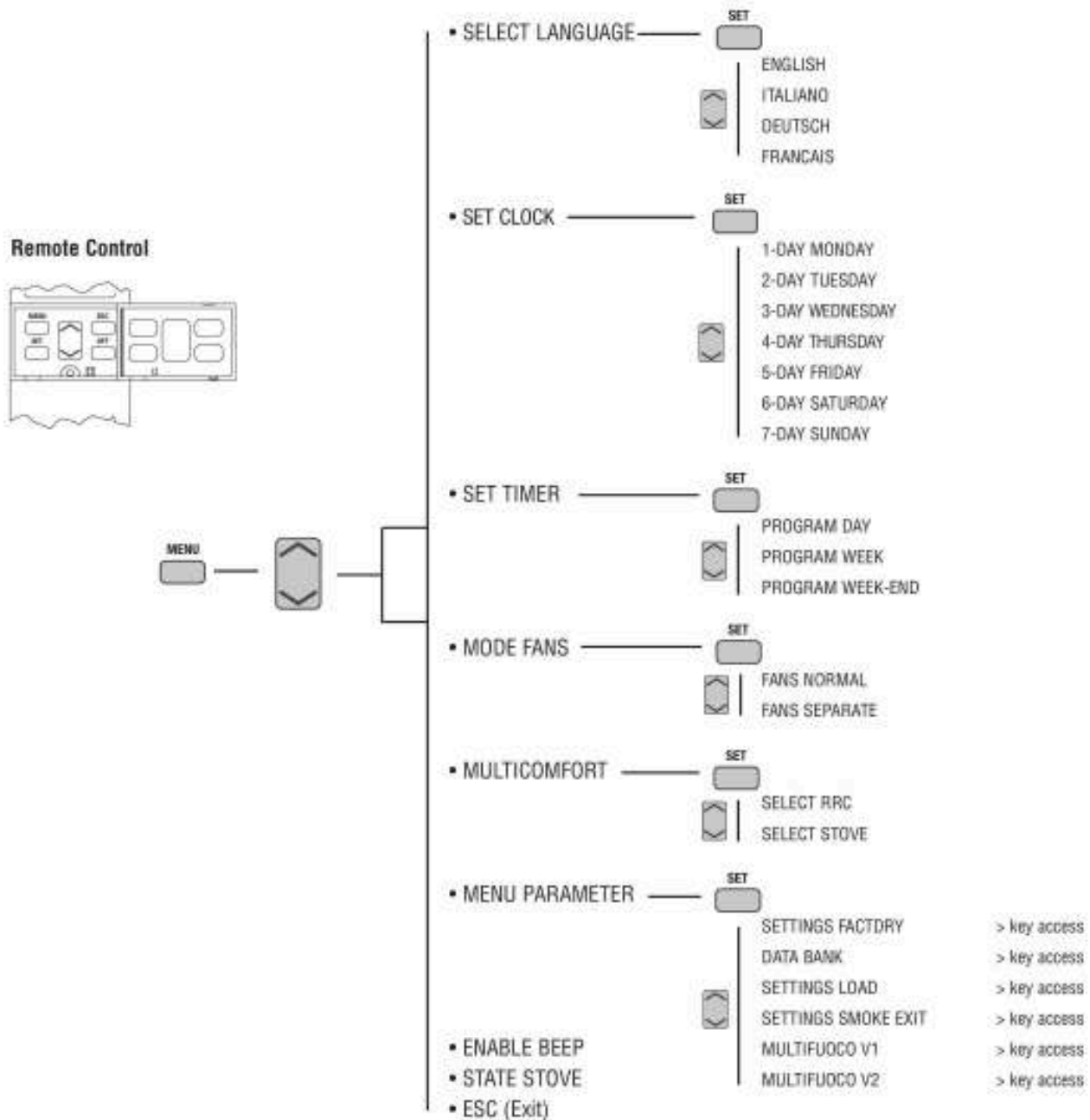





The remote control can be used to select the following functions from the main **MENU**:



These functions are activated by opening the front flap and pressing the following keys:

- the **MENU** key is used to access the main menu and return to the initial display at any time during programming to alter data that has been input incorrectly.
- the **MENU SELECT** key is used to scroll through the main menu and the submenus.
- the **SET** key is used to confirm a **MENU** or a selection.
- the **ESC** is used to return to the previous menu display at any time during programming to alter data that has been input incorrectly.

SET CLOCK (current day/time)

<i>Function</i>	<i>Action</i>	<i>Display</i>
Set the day	Press the MENU key, select the SET CLOCK menu using the SELECT MENU  key, then confirm by pressing the SET key.	
Confirm setting and move to next section.	Press the SELECT MENU  key and set the "day". Confirm by pressing the SET key.	
Set the hour.	Press the SELECT MENU  key and set the current "hour". Confirm by pressing the SET key.	
Set the minutes	Press the SELECT MENU  key and set the "minutes". Confirm by pressing the SET key. After confirmation the initial display will reappear.	

DT2840064-01

6.12 Timer





The timer allows the user to programme the stove to start up and shut down automatically without any manual intervention. Daily, weekly and weekend programmes can be selected with a maximum of two operating cycles in two separate timetable bands.









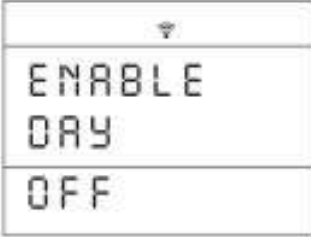



For example: *Cycle 1: from 6am until 9am*
 Cycle 2: from 8.30pm until 11pm

- In the DAILY programme the two timetable bands once established can be activated or deactivated for all the days of the week.
 For example: if you want the stove to operate from 6am to 9am every day
- In the WEEKLY programme the two timetable bands once established can be activated or deactivated for each day.
 For example: if you want the stove to operate from 6am to 9am on Monday, Tuesday, but not on Wednesday, and so on.
- In the WEEKEND programme the two timetable bands once established can be activated or deactivated for Friday, Saturday and Sunday.
 For example: if you want the stove to operate from 6am to 9am on Friday, Saturday, but not on Sunday.





This kind of timer allows you to have three programmes (DAILY, WEEKLY and WEEKEND) stored permanently. The programmes can be activated or deactivated using the SET TIMER menu. It is advisable to have only one programme active at a time to avoid overlapping.





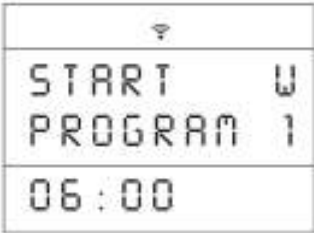
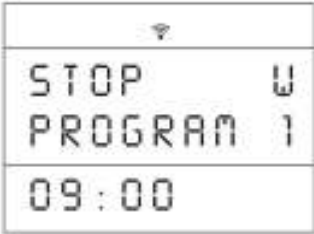

⚠ WHEN USING THE TIMER FOR THE FIRST TIME, SET THE CLOCK WITH THE CURRENT DAY, HOUR AND MINUTES, as with a new watch. To set the actual time, see the table SETTING THE CLOCK. This setting will only be necessary the first time of activating the clock.

PROGRAM DAY - 1st operating cycle		
Function	Action	Display
Select SET CHRONO menu	Press the MENU key. Using the SELECT MENU  key select the SET CHRONO menu and confirm by pressing the SET key.	
Select day programme	Using the SELECT MENU  key select the day-programme PROGRAM DAY menu and confirm by pressing the SET key.	
Enable or disable day programme	Press the SELECT MENU  key and select ON to enable the day programme or OFF to disable the day programme. Confirm by pressing the SET key. If you have disabled the programme by selecting OFF and do not wish to carry out further programming, press the ESC (EXIT) key to return to the previous menu or the MENU key to return to the initial display.	

<i>Function</i>	<i>Action</i>	<i>Display</i>
Set startup time for 1st operating cycle.	Press SELECT MENU  to set the startup time, advancing in ten-minute jumps (for example, you want the stove to start up at 06:00). Confirm by pressing the SET key.	
Set shutdown time for 1st operating cycle.	Press SELECT MENU  to set the shutdown time, advancing in ten-minute jumps (for example, you want the stove to shut down at 09:00). Confirm by pressing the SET key.	
	In this stage a shutdown time need not be set. Press SELECT MENU  , set the readout oFF and confirm by pressing the SET key.	
Set desired power for first operating cycle.	Press SELECT MENU  to set the desired power (for example you want power setting 1). Confirm by pressing the SET key.	
Set room temperature for first operating cycle.	Press SELECT MENU  to set the desired room temperature (for example, you want a room temperature of 25°C). Confirm by pressing the SET key. When the desired temperature has been reached the stove automatically reverts to power setting P1 and the temperature can be read on the remote or on the stove - see Multicomfort menu.	
Set desired Multifuoco fan speed for first operating cycle.	Press SELECT MENU  to set the desired fan speed (for example, you want fan speed setting 1). Confirm by pressing the SET key. Confirm by pressing the SET key. When programming the timer on the P960-P960F-P961 stove it is not possible to set separate fan speeds.	
After having programmed the first operating cycle you may, if you wish, proceed with programming the second operating cycle by going through the settings in the order as described above. The number 2 appears on the display to indicate the second operating cycle.		





PROGRAM WEEK













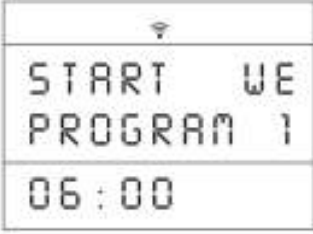

<i>Function</i>	<i>Action</i>	<i>Display</i>
Select set chrono menu	Press the MENU key. Using the SELECT MENU <input type="checkbox"/> key select the SET CHRONO menu and confirm by pressing the SET key.	
Select week programme	Using the SELECT MENU <input type="checkbox"/> key select the week-programme PROGRAM WEEK menu and confirm by pressing the SET key.	
Enable or disable the week programme	Press the SELECT MENU <input type="checkbox"/> key and select oN to enable the week programme or oFF to disable the week programme. Confirm by pressing the SET key. If you have disabled the programme by selecting oFF and do not wish to carry out further programming, press the ESC (EXIT) key to return to the previous menu or the MENU key to return to the initial display.	
Set startup time for 1st operating cycle.	Press SELECT MENU <input type="checkbox"/> to set the startup time, advancing in ten-minute jumps (for example, you want the stove to start up at 06:00). Confirm by pressing the SET key.	
Set shutdown time for 1st operating cycle.	Press SELECT MENU <input type="checkbox"/> to set the shutdown time, advancing in ten-minute jumps (for example, you want the stove to shut down at 09:00). Confirm by pressing the SET key.	
	In this stage a shutdown time need not be set. Press SELECT MENU <input type="checkbox"/> , set the readout oFF and confirm by pressing the SET key.	
Activate or deactivate the first operating cycle on individual days of the week.	Press the top part of the SELECT MENU <input type="checkbox"/> key to select the day of the week, then press the bottom part of the SELECT MENU <input type="checkbox"/> key to select oN to activate the first operating cycle on the chosen day or oFF to deactivate the first operating cycle on the chosen day. Active days will be shown on the DAYS OF THE WEEK display by the digits 1 MO - 2 Lu - 3 UE - 4 LH - 5 Fr - 6 SA - 7 Su. Confirm by pressing the SET key.	



<i>Function</i>	<i>Action</i>	<i>Display</i>
Set desired power for first operating cycle.	Press SELECT MENU  to set the desired power (for example you want power setting 1). Confirm by pressing the SET key.	
Set room temperature for first operating cycle.	Press SELECT MENU  to set the desired room temperature (for example, you want a room temperature of 25°C). Confirm by pressing the SET key. When the desired temperature has been reached the stove automatically reverts to power setting P1 and the temperature can be read on the remote or on the stove - see Multiconfort menu.	
Set desired Multifuoco fan speed for first operating cycle.	Press SELECT MENU  to set the desired fan speed (for example, you want fan speed setting 1). Confirm by pressing the SET key. When programming the timer on the P960-P960F-P961 stove it is not possible to set separate fan speeds.	
After having programmed the first operating cycle you may, if you wish, proceed with programming the second operating cycle by going through the settings in the order as described above. The number 2 appears on the display to indicate the second operating cycle.		

DT2048065-81

WEEKEND PROGRAMME

<i>Function</i>	<i>Action</i>	<i>Display</i>
Select set chrono menu	Press the MENU key. Using the SELECT MENU  key select the SET CHRONO menu and confirm by pressing the SET key.	
Select weekend-programme	Using the SELECT MENU  key select the PROGRAM WEEK-END weekend-programme menu and confirm by pressing the SET key.	





<i>Function</i>	<i>Action</i>	<i>Display</i>
Enable or disable weekend programme	Press the SELECT MENU  key and select on to enable the weekend programme or off to disable the weekend programme. Confirm by pressing the SET key. If you have disabled the programme by selecting off and do not wish to carry out further programming, press the ESC key to return to the previous menu or the MENU key to return to the initial display.	
Set startup time for 1st operating cycle.	Press SELECT MENU  to set the startup time, advancing in ten-minute jumps (for example, you want the stove to start up at 06:00). Confirm by pressing the SET key.	
Set shutdown time for 1st operating cycle.	Press SELECT MENU  to set the shutdown time, advancing in ten-minute jumps (for example, you want the stove to shut down at 09:00). Confirm by pressing the SET key.	
	In this stage a shutdown time need not be set. Press SELECT MENU  , set the readout off and confirm by pressing the SET key.	
Activate or deactivate the first operating cycle on Friday, Saturday and Sunday.	Press the top part of the SELECT MENU  key to select the day of the week, then press the bottom part of the SELECT MENU  key to select on to activate the first operating cycle on the chosen day or off to deactivate the first operating cycle on the chosen day. Do this for Friday, Saturday and Sunday (active days will be shown on the DAYS OF THE WEEK display) and confirm by pressing the SET key.	
Set desired power for first operating cycle.	Press SELECT MENU  to set the desired power (for example you want power setting 1). Confirm by pressing the SET key.	
Set room temperature for first operating cycle.	Press SELECT MENU  to set the desired room temperature (for example, you want a room temperature of 25°C). Confirm by pressing the SET key. When the desired temperature has been reached the stove automatically reverts to power setting P1 and the temperature can be read on the remote or on the stove - see Multicomfort menu.	

<i>Function</i>	<i>Action</i>	<i>Display</i>
Set desired Multifuoco fan speed for first operating cycle.	Press SELECT MENU  to set the desired fan speed (for example, you want fan speed setting 1). Confirm by pressing the SET key. When programming the timer on the P960-P960F-P961 stove it is not possible to set separate fan speeds.	
After having programmed the first operating cycle you may, if you wish, proceed with programming the second operating cycle by going through the settings in the order as described above. The number 2 appears on the display to indicate the second operating cycle.		

DT2048873-81

FAN MODE

This function allows you to have the two fans operating at the same speed (NORMAL FANS) or at different speeds (SEPARATE FANS). To make the most of the Multifuoco fan functions read the paragraphs MULTIFUOCO SYSTEM and MULTICONFORT OPERATION.

<i>Function</i>	<i>Action</i>	<i>Display</i>
Select fan mode menu	Press the MENU key. Using the SELECT MENU  key select the fan-mode MODE FANS menu and confirm by pressing the SET key.	
Select normal fans or separate fans.	Press the SELECT MENU  key and select separate fans FANS SEPARATE or normal fans FANS NORMAL . Confirm by pressing the SET key. After confirmation the remote control automatically returns to the initial display.	 





DT2048869-81

6.13 Multicomfort

The pellet stove is fitted with the Multicomfort function. This works in conjunction with the Multifuoco ventilation system to improve heat distribution. It allows the room temperature to be read from the stove or from the remote control, so that the Multifuoco settings can be varied according to the requirements of the rooms to be heated.

If the airflow from your stove has been ducted to other rooms you may read the temperature in the room where the stove is installed or in the room where the remote control is situated.



Example: your stove is installed in a small room and you are ducting the heat only from the rear of the stove (see solution 1 under the paragraph "Multifuoco system"). You can position the remote control in the room to where the hot air has been ducted and set the required temperature from this room. To carry out the necessary settings see the Multicomfort menu.

MULTICOMFORT		
<p><i>This function is used to choose the sensor for reading the room temperature: from the stove or from the remote control. To make the most of the Multifuoco fan functions read the paragraphs MULTIFUOCO SYSTEM and MULTICOMFORT OPERATION.</i></p>		
<i>Function</i>	<i>Action</i>	<i>Display</i>
<p>Select the MULTICOMFORT menu</p>	<p>Press the MENU key, then using the SELECT MENU  key select the MULTICOMFORT menu. Confirm by pressing the SET key</p>	
<p>Select the REMOTE CONTROL SENSOR (SELECT RRC) OR STOVE (SELECT STOVE)</p>	<p>Press the SELECT MENU  key and select SELECT RRC to read the room temperature from the remote control or SELECT STOVE to read the room temperature from the stove. Confirm by pressing the SET key. After confirmation the readout function enabled (FUNCTION ENGAGED) will appear on the display and the remote control will automatically return to the initial display.</p>	 

DT2048870-01

ENABLE BEEP (audio signal)

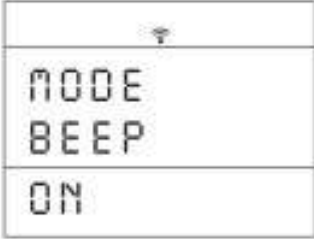

This function allows you to engage or disengage the alarm signal emitted by the stove to indicate that it has received the remote control's commands.

Function	Action	Display
Select enable beep menu	Press the MENU key. Using the SELECT MENU  key select the ENABLE BEEP menu and confirm by pressing the SET key.	
Select enable or disable beep.	Press the SELECT MENU  key and select on to enable the buzzer or off to disable it. Confirm by pressing the SET key. After confirmation the readout BUZZER ENABLES will appear on the display while the initial display will automatically reappear on the remote control.	

DT2040065-01

STATE STOVE

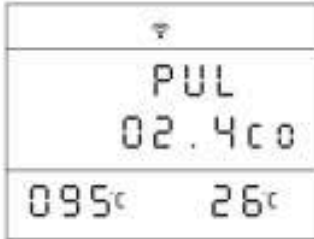

This function displays the stove status under the various operating conditions.

Function	Action	Display
Select stove status menu	Press the MENU key, then using the SELECT MENU  key select the stove status STATE STOVE menu. Confirm by pressing the SET key.	
Display stove status	<p>The first line displays the operating conditions, the second line for how long the pellets have been loading and the third line the smoke and room temperatures detected by the sensors. A list of the readouts which can appear in the first line is given below:</p> <ul style="list-style-type: none"> PUL Clean grate ALF Pressure switch activated ALC Safety thermostat activated No Conn Smoke sensor disconnected No Acc Failed ignition Mass temp Smoke alarm activated - maximum temperature reached 	

DT2040071-01

6.14 Modifying the transmission unit

Should two pellet stoves of the same model be installed close to each other and the remote control beam activates both simultaneously, it is possible to modify the transmission unit when the stove has been shut down by taking the following steps:

SELECT UNIT		
Function	Action	Display
Select UNIT function	Open the flap and press the SET and OPT keys simultaneously. Using the SELECT MENU \square key choose one of the eight transmission units (0÷7). Standard setting on pellet stoves is 0.	
Restart stove	Disconnect the power cable. Reconnect it and within five seconds press the ON/OFF key. Two display pages will appear in sequence while the remote control will return to the initial display.	
		

6.14 How the 'Multifuoco' system works

The pellet stove with **'Multifuoco' system** is equipped with a fan for the diffusion of hot air. This facility allows **multiple solutions for the diffusion of channelled hot air**, allowing the user freedom of choice as regards the number of adjoining rooms which can be heated.

The workings of the products **'Multifuoco' system** will be explained in general and conceptual terms below.

In order to adjust the action of the fan to suit the chosen redirection plan, a number of 'Multifuoco' settings have been preprogrammed: **M1, M2, M3, M4**. Once the **'Multifuoco'** setting has been chosen the user can then choose a greater or lesser quantity of heat by choosing one of the stove's five power settings.

There is a greater volume of air transferred by the fan rising from levels **M1** to **M4**. Similarly, there is a greater quantity of hot air being produced by the stove rising from level **P1** to level **P5**.

It is at the user's discretion, based on the experience he or she accumulates through acquaintance with the product in use, which of the 'Multifuoco' settings and which power level to choose. These choices will be based on the stove's location, the room temperature at the chosen startup time and of course on the desired room temperature.

For each of the solutions described in section **'Multifuoco' system** a specific **Multifuoco** fan setting has been preprogrammed - **M1, M2, M3, M4** - in order to adapt the rate of heat transferral to the chosen redirecting solution.

- If opting for **Solution 1**, it is best to use the control panel to select the corresponding setting **M1**. This setting will automatically adjust the fan speeds to the chosen solution and will work with all **FIVE** of the stove's power settings.
- If opting for **Solution 2**, a greater transferral of heat will be required, in which case it would be best to select setting **M2**.
- Finally, if opting for **Solution 3** and **Solution 4**, a yet greater transferral of heat will be required, in which case it would be best to select setting **M3** or **M4**.

Before choosing the desired Multifuoco setting, start the stove up and wait until it is operating normally.

6.16 Safety devices

 during operation some parts of the stove (door, handle, ceramic parts) can reach high temperatures.

Remember to maintain the safety distances indicated previously.

Be careful, take all due precautions and always comply with the instructions.



If during operation smoke leaks from any part of the stove or the flue, shut the stove down immediately and ventilate the room. When the stove has cooled, check for the cause of the leak and if necessary call in specialist personnel.

The stove is fitted with several safety devices to guarantee safe operation.

 The safety devices are fitted to eliminate the risk of injury to people and pets and damage to property. Tampering or work carried out by unauthorised personnel can jeopardise this function.



Possible warnings of problems

Simple operating problems can usually be resolved with the help of the following pages.

SMOKE CHAMBER PRESSURE		
<i>Sensor</i>	<i>Description</i>	<i>Display</i>
Pressure switch "ALF 1"	<p>Connected to the flue gas outlet, its function is to control the vacuum inside the outlet duct so that the stove can be used in all safety.</p> <p style="text-align: center;">WHEN ACTIVATED</p> <p>If correct operating conditions in the flue gas outlet change (incorrect installation, blockages or obstructions in the flue, poor maintenance, unfavourable weather conditions such as persistent wind, etc.) the pressure switch cuts off the power supply to the fuel-loading auger, thereby stopping the supply of pellets to the grate and starting the stove shutdown process.</p> <ul style="list-style-type: none"> - The readout 'ALF 1' appears in the STOVE STATUS mode. - The readout "SMOKE SAFETY" appears on the display. - After approx. 60 seconds the alarm sounds (if activated). 	
	<p style="text-align: center;">WHAT TO DO</p> <ul style="list-style-type: none"> - Shut down the stove by holding the ON/OFF key (1) down for several seconds. - The alarm stops. - Wait until you are sure that combustion of any pellets remaining in the grate has stopped. - Wait until the stove has cooled down, then check for and remove whatever has caused the safety device to be triggered. Finally, after having cleaned the grate restart the stove by pressing the ON/OFF key (1). 	
Pressure switch "ALF 2"	<p>Its function is to check correct operation of the pressure switch so that the stove can be used in all safety.</p> <p style="text-align: center;">WHEN ACTIVATED</p> <p>It activates during the "START" stage of the stove (see "STARTING THE STOVE" table).</p> <p>If an anomaly is detected in the pressure switch, the readout "ALF 2" appears in the STOVE STATUS mode. The readout "SMOKE SAFETY" appears on the display. After approx. 60 seconds the alarm sounds (if activated).</p>	
	<p style="text-align: center;">WHAT TO DO</p> <ul style="list-style-type: none"> - Shut down the stove by holding the ON/OFF key (1) down for several seconds. - The alarm stops. - Call the After-Sales Service Centre. 	

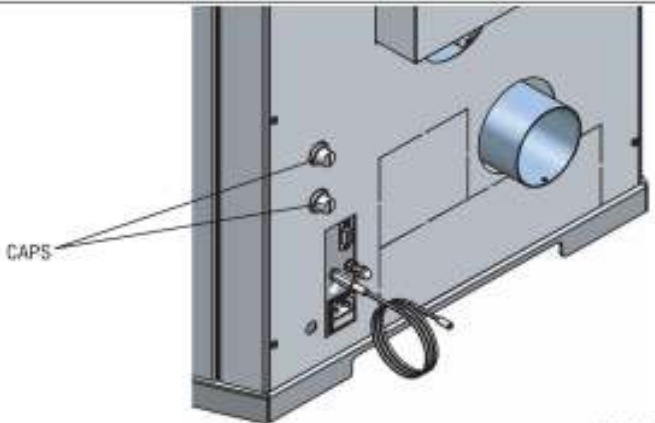

DT2048895-90

PELLET HOPPER AND STOVE HOUSING TEMPERATURE

<i>Sensor</i>	<i>Description</i>	<i>Display</i>
Thermostat 1 with manual reset	Located on the pellet hopper, its function is to prevent excessive temperature ranges.	
	<p style="text-align: center;">WHEN ACTIVATED</p> <p>If the pellet hopper temperature reaches critical levels, the thermostat cuts off the power supply to the fuel-loading auger, thereby stopping the supply of pellets to the grate and starting the stove shutdown process.</p> <ul style="list-style-type: none"> - The readout ALC appears in the STOVE STATUS mode. - After approx. 60 seconds the alarm sounds (if activated). 	
Thermostat 2 with manual reset	Located on the stove housing, its function is to check the temperature inside the stove and to ensure that the stove structure and operating mechanisms are not damaged.	
	<p style="text-align: center;">WHEN ACTIVATED</p> <p>If the stove temperature reaches critical levels, the thermostat will cut off the power supply to the fuel-loading auger, thereby stopping the supply of pellets to the grate and starting the stove shutdown process.</p> <ul style="list-style-type: none"> - The readout ALC appears in the STOVE STATUS mode. - After approx. 60 seconds the alarm sounds (if activated). 	
<p>WHAT TO DO IN BOTH CASES</p> <ul style="list-style-type: none"> - Shut down the stove by holding the ON/OFF key down for several seconds - The alarm will stop. - Wait until combustion of any pellets remaining in the grate has finished. <p>Before resetting the safety devices, make sure the stove has shut down and is completely cold, then proceed as follows:</p> <ul style="list-style-type: none"> - unscrew the two caps at the bottom left of the stove rear panel; - one at a time, press the two small buttons. If necessary use a slotted-head screwdriver and apply light pressure; - replace the two caps; - after having cleaned the grate, restart the stove by pressing the ON/OFF key (4). (The readout THERMAL CUTOUT must no longer appear on the display. If this is not the case repeat the process described above.) <p>With reference to standard EN 60335-1, a Piazzetta After-Sales Service Centre or an authorised person must be contacted after two resets.</p>		
		

DT2040053-01

FLUE GAS TEMPERATURE SENSOR

<i>Sensor</i>	<i>Description</i>	<i>Display</i>
Smoke sensor	<p>Connected to the electronic board, it constantly monitors the working temperature allowing the stove to be used in all safety.</p>	
	<p style="text-align: center;">WHEN ACTIVATED</p> <p>If the temperature exceeds the fixed safety limit the board cuts off the power supply to the fuel-loading auger thus depriving the grate of pellets and starting the stove shutdown process.</p> <ul style="list-style-type: none"> - The readout MASS TEMP and the flue gas temperature appear in the STOVE STATUS mode. - After approx. 60 seconds the alarm sounds (if activated). 	 <p>The display shows a warning icon (triangle with exclamation mark) and two bars on the left, and a Wi-Fi icon and two bars on the right. The main text reads 'SAFETY STOVE' in a digital font. At the bottom left is a small '1' and at the bottom right are three dashes.</p>
	<p style="text-align: center;">WHAT TO DO</p> <ul style="list-style-type: none"> - Shut down the stove by holding the ON/OFF key down for several seconds (4). - The alarm stops. - Wait until you are sure that combustion of any pellets remaining in the grate has stopped. - Check for and remove whatever has triggered the safety device. - After having cleaned the grate restart the stove by pressing the ON/OFF key (4). 	
Smoke sensor Disconnected	<p style="text-align: center;">WHEN ACTIVATED</p> <p>If the sensor is momentarily or accidentally removed from its normal position, or is not connected properly to the electronic board, the readout NO CONN and the flue gas temperature will appear in the STOVE STATUS mode. After approx. 60 seconds the alarm sounds (if activated).</p>	 <p>The display shows a warning icon (triangle with exclamation mark) and two bars on the left, and a Wi-Fi icon and two bars on the right. The main text reads 'PROBE SMOKE' in a digital font. At the bottom left is a small '1' and at the bottom right are three dashes.</p>
	<p style="text-align: center;">WHAT TO DO</p> <ul style="list-style-type: none"> - Shut down the stove by holding the ON/OFF key down for several seconds (4). - The alarm stops. - Wait until you are sure that combustion of any pellets remaining in the grate has stopped. - Check for and remove whatever has triggered the safety device. - After having cleaned the grate, restart the stove by pressing the ON/OFF key (4). 	

DT2048854-02

ROOM TEMPERATURE SENSOR

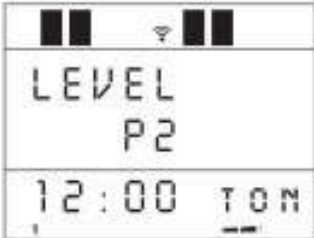
Sensor	Description	Display
Room sensor	Connected to the rear of the stove it constantly monitors the temperature in the stove's immediate environs to ensure its operation in complete safety.	
	<p style="text-align: center;">WHEN ACTIVATED</p> <p>If the sensor detaches itself momentarily and/or accidentally from its position, the problem does not require the immediate shutdown of the stove, which will continue to function normally at the chosen power level.</p> <p>The problem will be indicated on the display by the readout "ton".</p>	
	<p style="text-align: center;">WHAT TO DO</p> <ul style="list-style-type: none"> - Restore the sensor to its proper position. - If the temperature display has been activated this will once again be shown. 	

DT2048855-01

6.17 Opening the door

During operation the door must remain closed. It is to be opened only when the stove has been shut down and cooled for the carrying out of maintenance.

6.18 Humidifier (only stove P960-P961) - Fig. 62

The stove comes equipped as standard with a humidifier placed underneath the food warmer.

Once the stove's ceramic cover has been fitted, the humidifier can be filled with water using the spray bottle, by inserting the neck of the bottle into the hole provided.

The humidifier holds 500ml of water (as does the bottle) which will last between two and three days depending on the stove's use.

⚠ When refilling the humidifier do not exceed the maximum capacity, shown as MAX, and thereby damaging the stove's electrical parts.



DT2048855-00

6.19 Disposal of ashes

- The ashes should be placed in a metal container with a sealed cover. The sealed container should be placed on a non-combustible surface at a safe distance from combustible materials until the cinders have been completely extinguished.
- Only when they have been fully extinguished can the ashes be thrown away with organic waste, assuming that nails or other non-organic material are not present.
- Ash from natural (non-treated) wood burned in stoves or open fireplaces is composed mainly of calcium, silicon, potassium and magnesium oxides. The ashes can therefore be used as a fertiliser for plants or in the garden, albeit not exceeding 2.6 kg per 10m² annually.

Pursuant to current regulations on the safety of electrical equipment, you must contact a Piazzetta After-Sales Service Centre or a qualified electrician for all and any work connected with installation, maintenance or servicing that involves access to electrical parts.

Maintenance is to be considered compulsory for correct and efficient stove operation. If maintenance is not carried out with the recommended frequency, stove performance could suffer. The manufacturer will not be responsible for stove deterioration or malfunction if due to poor maintenance.

All maintenance work (cleaning, any replacements, etc.) must be carried out when the stove is shutdown and cold.

Do not use materials that could scratch or damage the glass, since scratches could become cracks. Under no circumstances use abrasive substances.

DT2810057-01

7.1 Cleaning the grate and the grate support - Fig. 63

Clean the grate area periodically (approx. once every two days) and whenever the stove is to be lit:

- Remove the grate baffle plate and lift out the grate.
- Remove any ash or other material that may have built up, taking particular care to free any clogged holes using a sharp pointed tool.
- Make sure the "ignition hole", located on the rear of the grate, is kept clean.
- Check the grate support and remove any ash.

The frequency of cleaning depends on how much the stove is used and the quality of the fuel.

⚠ After cleaning and before lighting the stove, check that the grate is correctly inserted and pushed back towards the lower rear baffle. Refit the grate baffle plate.

7.2 Cleaning the ash drawer

Every two days, check the ash drawer to see if it needs emptying. For the disposal of ashes see section 6.19.

7.3 Cleaning the combustion chamber - Fig. 63 / 66

Once a week clean the firebox as follows:

- remove the grate and the ash pan; (Fig. 64)
- loosen but do not remove the two hexagon-head brass screws M6 located on the sides in the top part of the two lateral baffles; (Fig. 65)
- with one hand lift the "Upper rear baffle"; (Fig. 65)

⚠ The "Upper rear baffle" is now free and could fall unless held with one hand.

- with the other hand tilt the "Lower rear baffle" outwards and then remove it; (Fig. 66)
- let the upper rear baffle return to its original position;
- using a vacuum cleaner remove the ash from the firebox;
- after having thoroughly cleaned the firebox, remount the pieces proceeding in the reverse order to above;

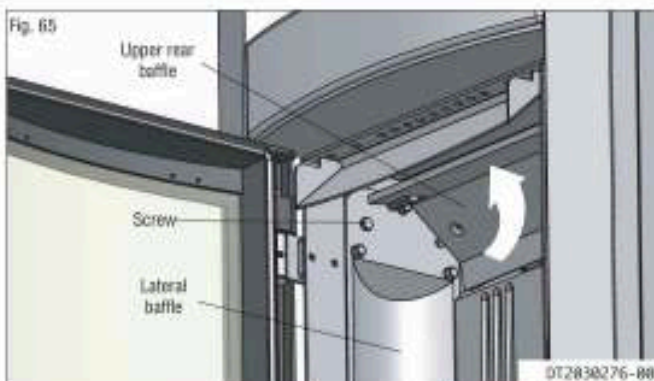
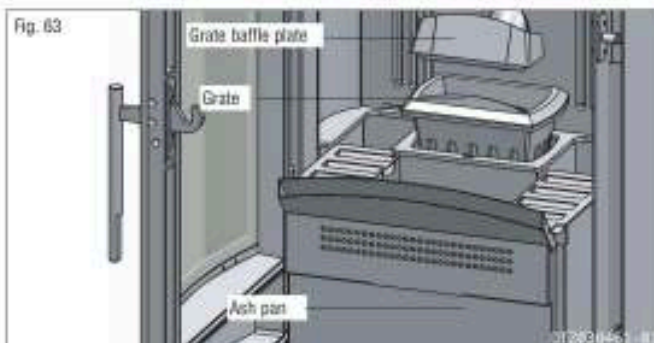

- ensure that the lugs of the "Lower rear baffle" are properly inserted into the relative notches in the sides of the firebox; (Fig. 66)
- now secure the "Lower rear baffle" by attaching it to the relative notches in the "Upper rear baffle".

⚠ This type of cleaning requires a vacuum cleaner suitable for holding ash.

7.4 Cleaning the combustion chamber (only P960 F) - Fig. 67 / 73

Furnace combustion chamber

Clean the combustion chamber once a week, proceeding as follows:

- remove the grate and the ash pan (fig 67);
- loosen the two M6 hexagonal-head brass screws found on the upper sides of the two side shields without removing them completely (fig 68);
- with one hand lift the furnace shield (fig. 68);

⚠ The rear shield is now loose and may fall

- With the other hand tilt the rear shield outward and remove it from its position (fig. 69);
- Let the furnace shield return to its normal position
- Using a vacuum cleaner remove the ashes which have built up in the combustion chamber (fig. 70);
- After carrying out a thorough cleaning reassemble the various parts, repeating the process in reverse order.

⚠ This type of cleaning operation requires a vacuum cleaner adapted to hold ashes.

Oven combustion chamber

Clean the oven annually, proceeding as follows:

- remove the grill from the oven
- loosen the bolt on the door's lower hinge and slide the pivot upwards. If necessary use a screwdriver to help (fig 71);
- loosen the bolt on the door's upper hinge. The pivot should automatically slide down and out.

⚠ At this stage the door is loose and may fall.

- Remove the oven's frame loosening the screws that hold it in place. Pay attention not to let it fall (fig. 72);
- Slide the oven out;
- Carry out the necessary internal cleaning using a vacuum cleaner to remove any ash or carbon deposits which have built up;
- Reassemble all the parts, repeating the process in reverse order.

⚠ While reassembling the oven pay attention that the temperature sensor is inserted into the correct hole on the oven's rear (fig 73).

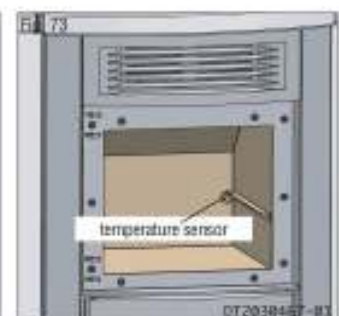
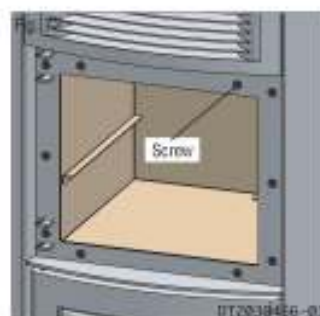
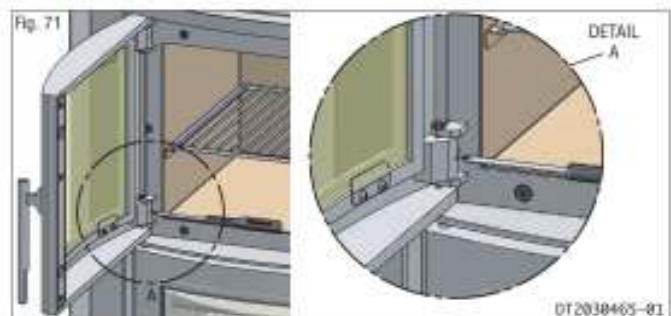
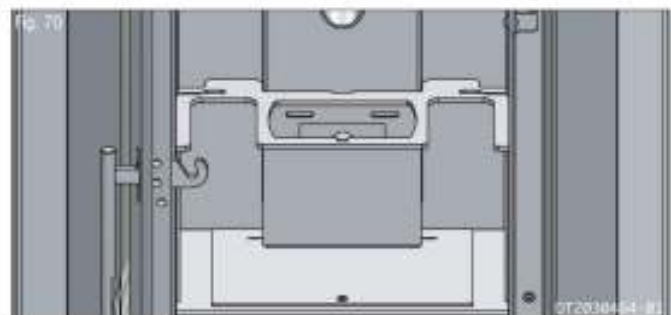
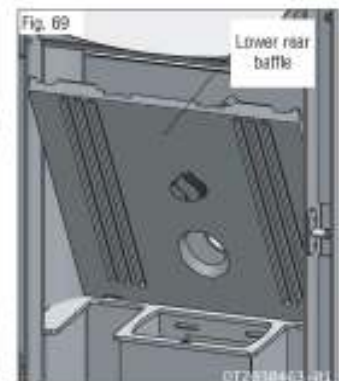

7.5 Cleaning the smoke chamber - Fig. 74 / 76

Once a year clean the smoke chamber as follows:

- Remove the screw which secures the smoke chamber closing element, then lift the element slightly and remove it by pulling it towards you. (fig 74, 75).
- Use a vacuum cleaner to remove any ash and carbon deposits which can accumulate in the chamber, taking care not to damage the blades of the fan.
- Check the hole inside the smoke chamber at the rear (leading to the device for measuring the vacuum) for dust and ash and clean if necessary (fig. 76).
- After thorough cleaning, change the gasket and replace the smoke chamber closing element.

7.6 Cleaning the flue system

In order to get the most from your product we recommend that this maintenance be carried out on a monthly basis.

Remove the plug from the Tee and clean the pipes.

If necessary, particularly on the first few occasions, we recommend calling in a qualified technician.

7.7 Cleaning the ceramic cladding

The ceramic cladding must first be cleaned with a soft dry cloth before using any detergent (even mild detergent).

Products are available on the market which are suitable for cleaning ceramics as well as concentrated products for cleaning porcelain. These will remove oil, ink, coffee and wine stains, etc.

NEVER SOAK THE CERAMIC CLADDING OR CLEAN IT WITH COLD WATER WHEN IT IS STILL HOT AS THE THERMAL SHOCK COULD CAUSE IT TO CRACK.

7.8 Cleaning the enamelled metal parts

When cleaning the enamelled metal parts of the product use a soft cloth moistened with water.

NEVER CLEAN METALLIC PARTS USING ALCOHOL, SOLVENTS, PETROLEUM-BASED PRODUCTS, ACETONES OR OTHER DEGREASING OR ABRASIVE SUBSTANCES.

In the event of such substances being used the manufacturer will not be responsible for any damage caused.

Discolouration of metallic parts may be the result of misuse.

7.9 Cleaning the glass (DAILY)

The glass should be cleaned when cold using ammonia-based degreasing agents and not corrosive substances such as solvents.

If the appliance is very slow to heat up in the ignition phase due to fuel that isn't completely dry, this is likely to cause a build-up of tar on the glass. This will eventually burn off when the secondary air supply is opened (if the appliance is equipped accordingly) or when the appliance is operating at full capacity. If the tar is left to build up over a long period it will require more effort to remove

We therefore recommend that the glass be cleaned daily before lighting the stove.

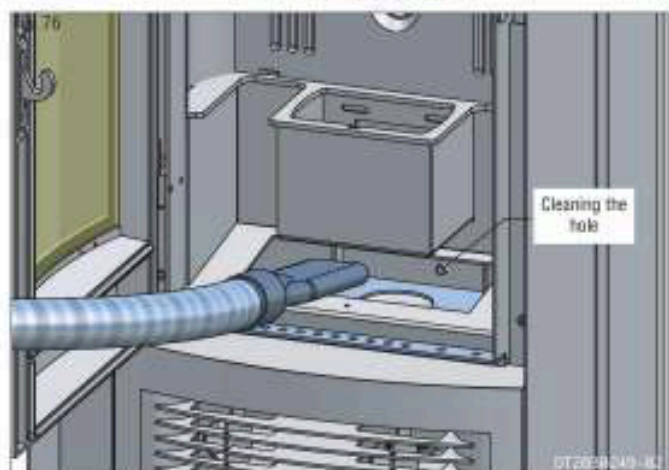
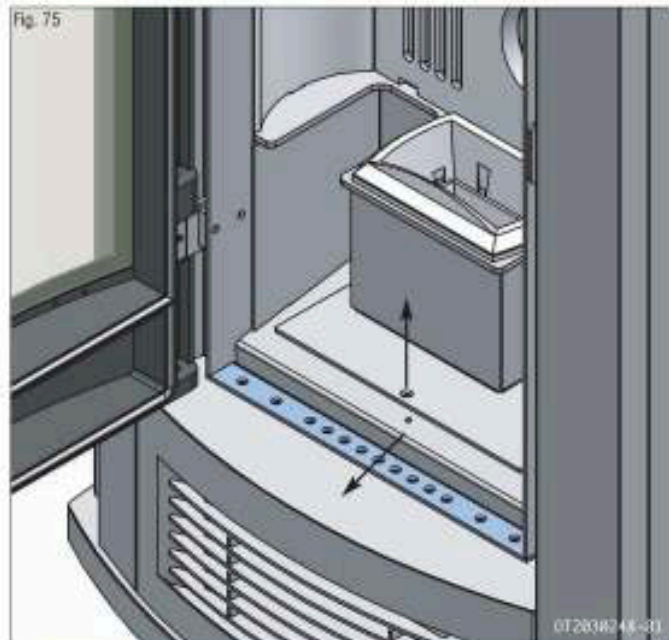
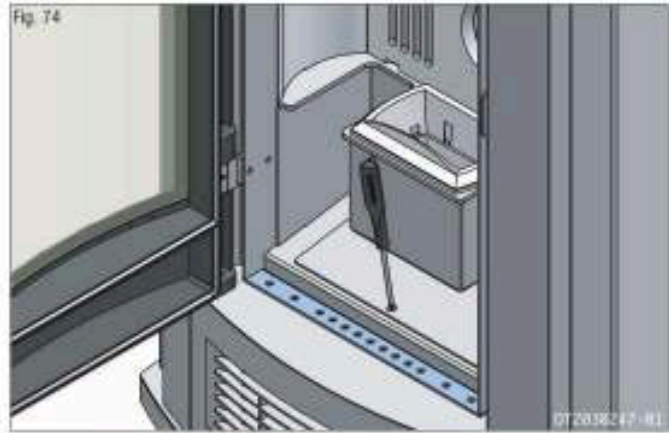

 **Do not use any material that could scratch or spoil the glass, as scratches may develop into cracks or breaks.**

7.10 Replacing the window

The stove is fitted with a 4mm thick glass panel, resistant to thermal shock up to 750°C; the glass can only be broken by heavy impact or misuse. Do not slam the door or hit the window.

In case of breakage replace only with a Gruppo Piazzetta spare part.

To replace, proceed as follows:

- wear protective gloves;
- remove the door and lie it flat;
- loosen the screws visible on the inside of the door;
- remove the frame and glass carefully;
- if the fibreglass seal and glazing bead have deteriorated, replace them;
- change the glass panel then replace the frame, tightening the screws carefully but not excessively;
- remount the door.

If other problems occur, consult your nearest retailer.

7.11 Replacing the remote control battery

Disconnect the appliance from the electricity supply by pulling out the plug.

Slide the cover off the back of the remote control and replace the batteries with new ones ensuring that the (+) and (-) directions are correct.

The batteries must be of the type **AAA (LR03) 1.5V**.

Replace the back cover on the remote control.

Reconnect the appliance to the electricity supply.

The writing shown to the side appears on the display of the remote control.

A feedback procedure between the remote control and the receiver starts automatically and it is necessary to wait a few moments until the initial display returns before using the remote control.



If the above sequence has not been followed correctly as described: open the remote control flap; press the SET and OPT buttons simultaneously and program the transmission unit. See "Changing the transmission unit" paragraph.

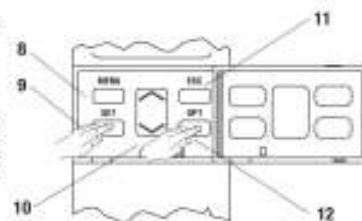

The new batteries must be of the same type as above; failure to comply with these instructions could cause a risk of explosion.

The old batteries must be disposed of properly in compliance with the applicable laws in force.

7.12 Cleaning the fans



Any cleaning or maintenance work must be carried out after the CURRENT HAS BEEN SWITCHED OFF.

The stove is fitted with fans (smoke extractor and heating) positioned at the bottom rear of the stove. Any build-up of dust or ash on the blades can unbalance them resulting in noise during operation.

It is necessary to have the fans cleaned annually. Since such an operation involves dismantling certain parts of the stove, have the cleaning carried out only by a Piazzetta Service Centre or other qualified persons.

7.13 When not in use

When shutting the stove down for the summer, proceed as follows:

- remove all pellets from the hopper and feeding auger;
- carefully clean the grate, the grate support, the firebox and the ash drawer;
- clean the flue thoroughly; contact a professional chimneysweep for this purpose;
- clean all dust, cobwebs, etc. from the area behind the inner lining panels once a year, in particular the fans.
- Disconnect the power cable from the power supply.

7.14 Extraordinary maintenance

The following maintenance should be carried out ONCE A YEAR and is necessary to ensure efficient and safe stove operation.

- Clean the firebox thoroughly.
- Clean and inspect the flue.
- Check the condition of seals and gaskets.
- Clean mechanical and moving parts (motors and fans).
- Check electrical and electronic components.

Some of the problems indicated below may be resolved by following the instructions. All work must be carried out when the appliance is cold and disconnected from the electricity supply (pull out the plug). Authorised qualified persons must be contacted, in accordance with current regulations, whenever it is necessary to work on parts inside the cladding or the firebox in order to resolve the problem.

Unauthorised tampering with the appliance or the use of other than original spare parts invalidates the warranty and relieves the manufacturer from all liability.

Problems caused by incompetent or insufficient maintenance or by failure to comply with the instructions in the installation and operating booklet for the product relieve the manufacturer from all and any liability.

PROBLEM	CAUSE	SOLUTION
The control panel display is not lit	The appliance is not powered	Check that the power cable is plugged into the wall socket and connected to the appliance
	Faulty power cable	Replace the power cable (use only original spares)
	Fuses blown	Check the fuses in both the plug and the electronic board, replacing them if necessary. If the problem persists call an electrician
	Faulty control panel	Replace the control panel (use only original spares)
	Faulty flat cable	Replace the flat cable (use only original spares)
	Faulty electronic board	Replace the electronic board (use only original spares)
Stove combustion gas safety device "ALF 1" stove status	Blocked flue or flue gas outlet	Check and clean the flue and the outlet
	Broken smoke extractor	Replace the motor (use only original spares)
	Flue system too long	Check correct installation (see section 5)
	Damaged door sealing gaskets	Check all the gaskets and seals of the door and flue pipe
	Hose connection blocked	Dismantle and clean the hose connection for the vacuum gauge
	Silicone piping blocked or broken	Check and/or replace piping
	Faulty electronic board	Replace the electronic board (use only original spares)
Pressure switch "ALF 2" malfunction	Faulty pressure switch	Replace the pressure switch (use only original spares).
	No power supply to the auger	Check the electrical connections (contact a Piazzetta After-Sales Service Centre or an authorised person).

PROBLEM	CAUSE	SOLUTION
Thermal cutout "ALC" stove status (Hopper thermostat)	Blocked flue	Check and clean the flue
	Grate requires cleaning	Clean the grate (see section 7.1)
	Faulty thermostat	Replace hopper thermostat (use only original spares)
	Badly positioned manual reset thermostats	Check that the thermostat sensor is correctly positioned
	Faulty electronic board	Replace the electronic board (use only original spares)
	Faulty fan	Check fan operation and replace if necessary (use only original spares)
	Temporary power failure during operation	Manually reset the pressure switches (see "ALC") With reference to standard EN 60335-1, a Pazzetta After-Sales Service Centre or an authorised person must be contacted after two resets.
Thermal cutout "ALC" stove status (Stove structure thermostat)	Blocked flue or flue gas outlet	Check and clean the flue and the outlet
	Faulty thermostat	Replace the thermostat (use only original spares)
	Badly positioned thermostat	Check that the thermostat sensor is correctly positioned
	Faulty electronic board	Replace the electronic board (use only original spares)
	Temporary power failure during operation	Manually reset the pressure switches (see "ALC") With reference to standard EN 60335-1, a Pazzetta After-Sales Service Centre or an authorised person must be contacted after two resets.
	Faulty fan	Check fan operation and replace if necessary (use only original spares)
"No ACC" stove status	Empty hopper	Fill the hopper
	Grate requires cleaning	Clean the grate (see section 7.1)
	Operating temperature not reached	Empty the grate and restart
	Faulty glow plug (igniter)	Replace glow plug (use only original spares)
	Faulty electronic board	Replace the electronic board (use only original spares)

PROBLEM	CAUSE	SOLUTION
Stove safety device "MASS TEMP" stove status	Blocked flue or flue gas outlet	Clean the flue and the outlet
	Faulty electronic board	Replace the electronic board (use only original spares)
	Faulty limit temperature control sensor	Replace the control sensor (use only original spares)
	Badly positioned smoke sensor	Check that the sensor is correctly positioned (see wiring diagram)
	Incorrect parameter settings	Check parameter settings
Smoke sensor "NO CONN" stove status	No connection between 2-pin terminal and electronic board	Check correct insertion/position of the connector (see wiring diagram)
	Faulty electronic board	Replace the electronic board (use only original spares)
	Badly positioned smoke sensor	Check that the sensor is correctly connected
Appliance runs for 9-10 minutes and then goes out	Heat sensor locked	Repeat ignition procedure. If the problem persists, contact an authorised technician
	Combustion gases have not reached the required ignition temperature	Repeat ignition procedure. If the problem persists, contact an authorised technician
	Heat sensor badly connected	Check the wiring and connections
	Blocked flue	Clean flue system
	Failed ignition	See "NO REC"
	Faulty electronic board	Replace the electronic board (use only original spares)
	Pellet-charging system blocked	Empty the pellet hopper; check and clean the auger and chute

 This instruction booklet contains all the necessary information for installation, operation and maintenance. Only call the Gruppo Piazzetta S.p.A. service centre after having scrupulously followed all the instructions.

8.1 Replacing the fuses

Electronic board fuse.

Unscrew the cartridge fuse or safety plug from the electronic board and replace with a similar one.

Motherboard fuse type: F4AL250V

Fan card fuse type: F500MAL250V

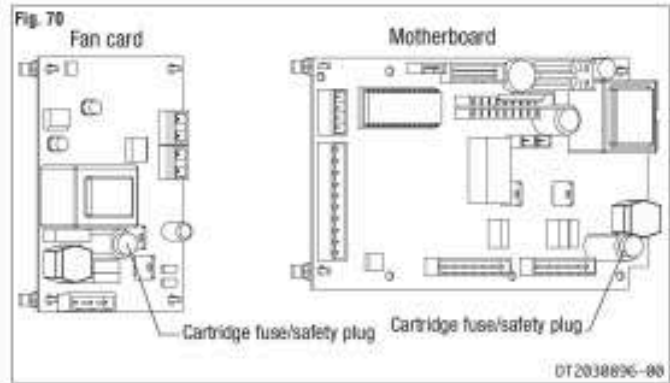

Fuse on the IEC power socket.

Draw out the fuse carrier and replace the fuse with the spare to be found inside the small drawer.

Type: F4AH250V

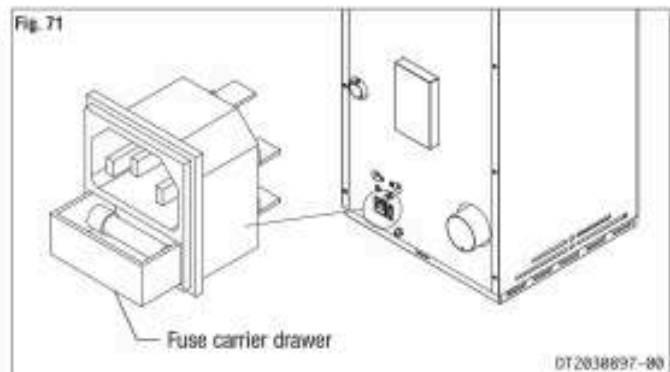

Piazzetta Pellet Stove Guide to Setting Flue Parameters (Installer Information Only)

This guide is supplementary to the Installation Instructions, which should be read before setting the flue fan parameters. It must only be carried out by an authorised installation engineer with the correct equipment. Whilst the appliance will normally operate as set in the factory, for optimum performance the flue gas fan must be adjusted to allow for variations in individual flues.

General

Before starting ensure the hopper contains enough pellets. Pellets must be fresh and dry. Remove any unburnt pellets and ash from the grate.

Ensure any controls (boiler stove) are calling for heat.

Note that the first ignition attempt may fail to 'No lit' as the auger takes time to fill before dropping pellets into the grate. If this happens restart the stove.

Connect a suitable micromanometer / draught gauge to the pressure tapping point on the rear of the stove (remove brass cap nut). The draught gauge needs to measure values of up to about 120 Pascals (Pa) with 1 Pa steps. (A gas CO / CO2 analyser such as the Anton Sprint usually have a suitable pressure scale). Note the pressures are negative.

Record the pressure at each setting after adjustment for future reference.

See relevant section as to using the remote or the keypad (always use the remote where it is supplied)

Setting Parameters using the Remote Control

Start the appliance.

Open the flap on the remote and follow the procedure in sequence

Note: *esc* returns you to the previous memory, *set* confirms the menu or setting

- Press *menu*
- Use the up/ down arrows to find *menu parameter*
- Press *set*
- Use the up/ down arrows to find *setting smoke ext*
- Press *set*
- Use the up/ down arrows to find *A9*
- Press *set*
- Use the *set* button to scroll through the parameters and adjust each one as necessary as you get to it. If you pass the parameter you need to adjust press *esc* to return to the previous menu and start again. Check and adjust if necessary parameter 16P. **Note** this must be done during *Phase 1*

Note: The setting value of the parameter is adjusted using the up/ down arrows and watching the micromanometer to obtain the correct pressure. Changes to the pressure are immediate but wait for it to settle and record the final result (Pa).

- Press *set* to confirm the setting and move to the next parameter
- Parameter 17P must be set during *Phase 2* adjusting as above to obtain the correct pressure

The rest of the parameters must be set when the whole flue system is up to temperature. For boiler stoves the water temperature must also be at least 60 deg C.

Note the parameters 18P to 22P are the settings for the different power output levels 1-5, or for stoves with 4 power levels 18P to 21P

- Access the highest power level (22P or 21P) first using the method above
 - Adjust the setting to obtain the correct pressure and *set* to confirm
- Adjust the other parameters in reducing order 21P, 20P, 19P, 18P and *set* each to confirm

After adjusting the parameter exit the programming by pressing *menu*

Pressure values must never be lower than 60 Pa (the limit of safety threshold). If higher pressures are set than recommended it can cause pellets to 'float' in the grate and not light.

Parameter Pressure Settings

The pressure settings are obtained from Robeys Limited 01773 820940 or contact info@robeys.co.uk You will need to have the Firmware version information. To obtain this press the select key 'up' key for 5 seconds to display the version.

After setting parameters remove the micromanometer and ensure that the brass cap nut is refitted

Setting Parameters using the Keypad on the Stove (Superior)

Identify the microprocessor and record the details. To do this switch on the stove, the identification code appears for a few seconds on the display, press the 3 *set* key followed by the 4 *on/off* key

Note the keys have a number in the corner which is used for identification

Key 3 confirms any setting and moves the display to the next parameter

Pressing key 4 at any time will exit from programming.

Start the stove and wait for it to complete the 20 second stage *Start o*

- Press key 5 for 10 seconds to obtain the input port to the programming functions
 - Use keys 1 and 2 to obtain code E9 on the display
 - Press 3 *set* to enter the programming mode, showing 01P
 - Press 3 *set* to move to the next parameter and repeat until 16P appears
- Check and adjust parameter 16P **Note** this must be done during the ignition stage *Start oo*

Note: The change made to parameter 16P is not sensed by the micromanometer immediately, at this stage set the pressure between 110 and 120 Pa using keys 1 and 2 and watching the micromanometer to obtain the correct pressure. To check if the new setting is correct it will be necessary to go through the other parameter settings, exit the program, then after stabilising re-enter the program and check the value on the micromanometer. Repeat if necessary.

- Press 3 *set* to confirm the setting and move to the next parameter
 - Exit the program by pressing key 4
 - Wait until the stove enters the stabilisation stage *Start ooo*
 - Enter the programming as before and go to parameter 17P
 - Check the pressure, at this stage it is advisable to have a pressure between 100 and 110 Pa
 - Adjust if necessary as above
- Exit the program by pressing key 4

The rest of the parameters must be set when the whole flue system is up to temperature. For boiler stoves the water temperature must also be at least 60 deg C.

Note the parameters 18P to 22P are the settings for the different power output levels 1-5, or for stoves with 4 power levels 18P to 21P. These are now set for their true operating powers.

- Enter the programming as above
 - Go to parameter 18P, the pressure should be 65-70 Pa, adjust as necessary and allow it to settle
 - Press 3 *set* to confirm the setting and move to the next parameter
 - Check parameter 19P, the pressure should be 65-70 Pa, adjust as necessary
 - Press 3 to confirm, move to 20P, the pressure should be 75-80 Pa, adjust as necessary
 - Press 3 to confirm, move to 21P, the pressure should be 75-80 Pa, adjust as necessary
 - Press 3 to confirm, move to 22P, the pressure should be 75-80 Pa, adjust as necessary
 - Recheck parameters 16P and 17P
- Exit the program by pressing key 4

After setting parameters remove the micromanometer and ensure that the brass cap nut is refitted

EUROPEAN REGULATIONS

This product "Stove P950 - P955 - P956" with Multiconfort has been designed, tested and manufactured according to the European R&TTE Directives 1999/5/EC. Following these Directives, this product can be installed in the following countries:

(BE) Belgium

(DK) Denmark

(GR) Greece

(ES) Spain

(FR) France

(IRE) Ireland

(IT) Italy

(LU) Luxembourg

(NL) The Netherlands

(AT) Austria

(PT) Portugal

(FI) Finland

(SE) Sweden

(UK) Great Britain

(NO) Norway

(DE) Germany

(CH) Switzerland

Robeys

A PASSION FOR QUALITY

Robeys Ltd
Goods Road, Belper, Derbyshire. DE56 1UU
Tel 01773 820940 Fax 01773599309
Email info@robeys.co.uk www.robeys.co.uk



GRUPPO  PIAZZETTA S.p.A.

Via Montello, 22
31011 Casella d'Asolo (TV) - ITALY
Tel. +39.04235271 - Fax +39.042355178
<http://www.piazzetta.it>
e-mail: infopiazzetta@piazzetta.it