



Owners Manual



1050



Whole Hog



450



570



680



Tailgater

**You must read this Owner's Guide
before operating your grill**

*Savor the
Flavor!*



DGI Dansons Group Inc.
Responsible Resource Development
"The Innovators."

- Mesquite
- Hickory
- Alder
- Oak
- Apple
- Cherry
- Pecan



Toll Free 1-877-303-3134

www.countrysmokers.com

"The Innovators."

Dear "Louisiana Grill" Wood Pellet Barbecue Owner:

Thank you for choosing to purchase a "Louisiana Grill Country Smoker" wood pellet smokin' grill.

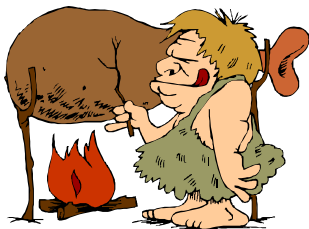

Cooking with your Louisiana Wood Pellet Grill is about to bring you full circle from the days of the caveman when cooking outdoors and with wood was a necessity, to cooking indoors in your modern kitchen and now back to the great outdoors and that savory wood flavor.

Think of your "Louisiana Grill" as an extra stove available to bake, roast, grill, sear and smoke food. Barbecuing provides a form of entertainment, which is relaxed and casual. Your meals can be completely cooked outdoors and where the chief is one of the crowd.

We'd like to take this opportunity to pass on a few **important tips** concerning grilling with wood pellets.

1. **Initial set-up of our "Louisiana Grill" is the most important step** to ensure the efficient and satisfactory operation of your barbecue for many years to come.
2. **Be diligent in your cleaning and maintenance program. Taking care of your grill will add years of life and keeps it looking great.**

Our loyal staff, valued customers, friends and our loving families have all contributed recipes to our cookbook. We have tried to include a broad range of cuisines and styles, starting with Mom's Great Home Cooking and many, many, many, catering and entertaining experiences to current classics and new soon to be classics.

If you are interested in contributing a family favourite, please send it by:
Fax: 1-877-303-3135, Web: www.louisiana-grills.com, or Mail: to the address below.

With a minimum of care your "Louisiana Grill" will provide years of clean, efficient and environmentally sound cooking. And be prepared for those never ending compliments. Thank you for choosing "Louisiana Grill".

Dansons Group Inc.

COPYRIGHT NOTICE

Copyright 2007, **Dansons Group Inc.** All rights reserved.
No part of this manual may be copied, transmitted, transcribed, stored in a retrieval system, in any form or by any means without the expressed written permission of,

Dansons Group Inc.; 26319 Twp Rd 53, Acheson, AB, Canada T7X 5A3



DANGERS & WARNINGS

FAILURE TO FOLLOW THE DANGERS, WARNINGS AND CAUTIONS CONTAINED IN THIS OWNER'S MANUAL MAY RESULT IN SERIOUS BODILY INJURY OR DEATH, OR IN A FIRE OR CAUSE DAMAGE TO PROPERTY.

DO NOT PLACE THE "TAILGATE" MODEL DIRECTLY ON A COMBUSTIBLE SURFACE. THERE MUST BE A NON-COMBUSTIBLE SURFACE BETWEEN THE SMOKER AND A COMBUSTIBLE SURFACE.

- Do not store a spare or disconnected liquid propane cylinder under or near this barbecue.
- After a period of storage, and/or non-use, the Louisiana Grill Barbecue should be checked for burner obstructions before use. See instructions in this manual for correct procedures.
- Do not put a barbecue cover or anything flammable on, or in the storage area under the barbecue.
- Children should never use your Louisiana Grill barbecue while unattended. Accessible parts of the barbecue may be very hot. Keep young children away while it is in use.
- You should exercise reasonable care when operating your Louisiana Grill barbecue. It will be hot during cooking or cleaning and should never be left unattended or moved while in operation.
- Do not use lava rock, wood chunks or charcoal in your Louisiana Grill.
- Never lean over open grill or place hands or fingers on the front edge of the cooking box.
- Should a grease fire occur, turn off the control and leave lid closed until the fire is out.
- Do not enlarge burn grate orifices, igniter holes or burner pots when cleaning the grill
- "Louisiana Grills" should be cleaned on a regular basis.
- Use heat-resistant barbecue mitts or gloves when operating barbecue.

WARNING:

Do Not transport your "Country Smoker" while operating or while the smokin' grill is HOT. Make sure the fire is completely out and that the smoker is com-

- Do Not use your grill in the rain or around any water source.
- Keep the back side of the grill a minimum 12 inches or safe distance from combustibles.
- Always unplug the grill before servicing.
- If the Country Smoker is stored outside during the rainy season or seasons of high humidity care should be taken to insure that water does not get into the pellet hopper. Wood pellets, when wet, expand greatly, break apart, and could jam the feed system.

It is a highly recommended practice to always go through the basic SET UP PROCEDURES after every 1 to 2 cookings. This will ensure proper ignition, heat output and many continuous happy grilling experiences.

Savor the Flavor!



CONTENTS

UNPACKING YOUR GRILL	5
PROPER COMPONENT PLACEMENT	5
HOW YOUR LOUISIANA GRILL WORKS	6
TAILGATE MODEL	7
450, 570, 680 MODELS	8
1050 & THE WHOLE HOG MODELS	9
STANDARD FEATURES	
ARCHED FLAVOR GUARD	10
BURN POT & BURN GRATE	10
CONTROL PANEL	11
FAN COOLED HOPPER	12
PAINT GRADE FINISH	12
COOKING GRIDS	12
ABOUT WOOD PELLETS	13
OPERATION	
INITIAL SET-UP	14
GETTING STARTED	15
LIGHTING – AUTOMATIC	17
LIGHTING – MANUAL	18
SHUTTING OFF YOUR SMOKER	19
MAINTENANCE	
GRILL MAINTENANCE	19
SLOWING DOWN FOR THE SEASON	21
WARRANTY	
LIMITED WARRANTY	22, 23
WIRING DIAGRAM	24
PARTS & SERVICE	24

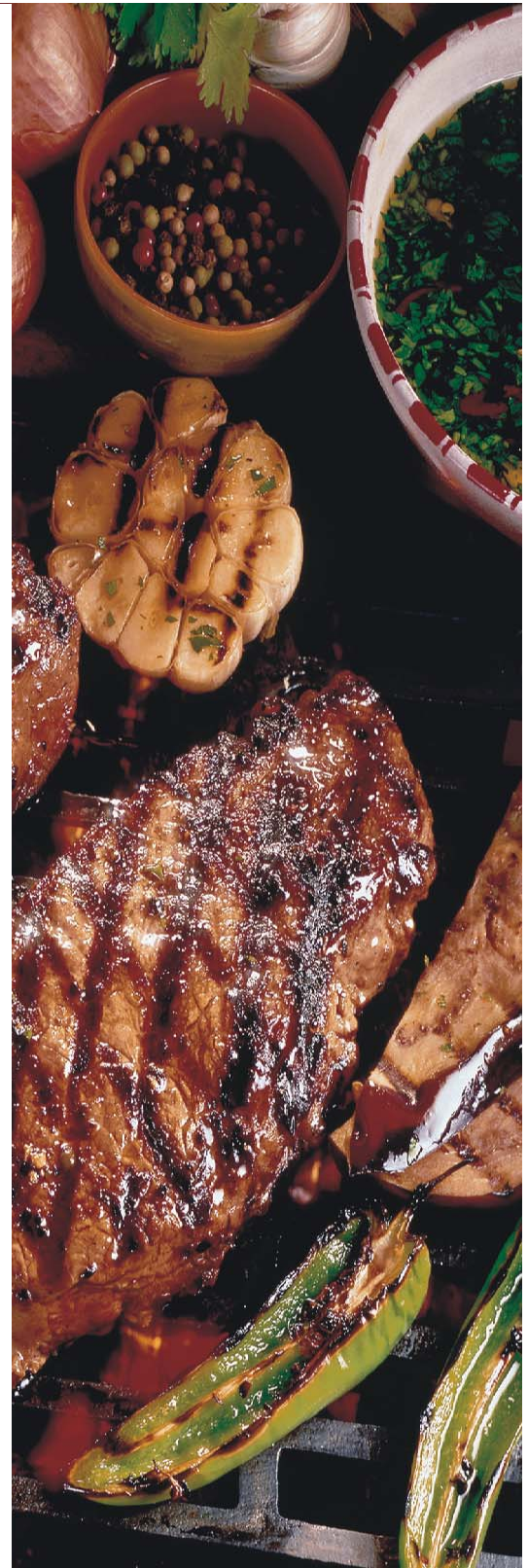

UNPACKING YOUR COUNTRY SMOKER

Your new Louisiana Grill "Country Smoker" may require some assembly. Please note that during shipping some movement may have taken place, so a complete visual inspection is required.

TIP Be sure to inspect entire grill after removing the protective shipping carton. Report any damage to your local dealer immediately. Shipping damage is not covered under warranty.



TG300 model

Tool Required:

1 - Phillips Screwdriver 5/8" socket and driver

Procedure:

You will find 4, 3" long Phillips wood screws inside securing the grill legs to the shipping crate. Back these out. Gently remove your grill from the shipping pallet and place either on a non-combustible surface or install on the leg system.

450, 570, 680, 1070 and Whole Hog model

Procedure:

You will find the smokin grills attached to the shipping pallet using 2 x 5/8" bolts. Reach under the shipping pallet and completely back out the threaded bolts. Gently remove your grill from the shipping pallet and install the 2 threaded levellers on the bottom of the engineered legs.

PROPER COMPONENT PLACEMENT

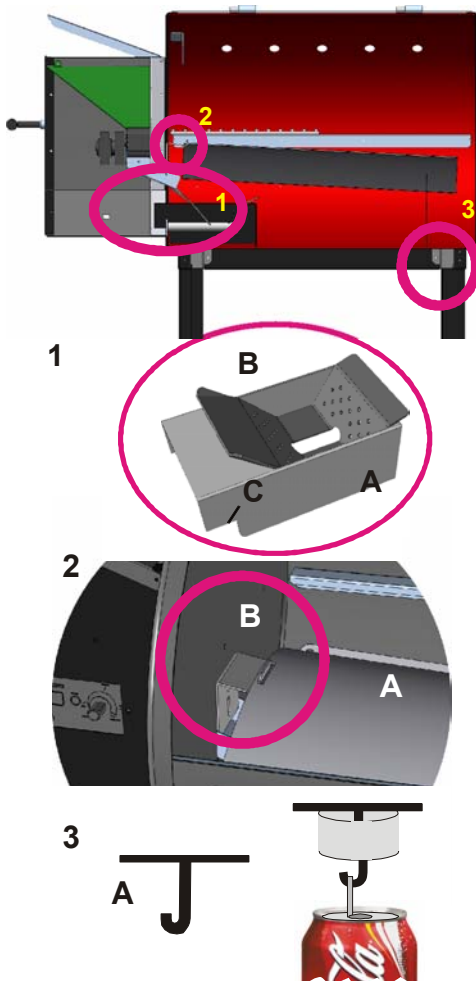

Proper placement is vital to proper performance.

During shipping and after any general movement, it is important to inspect and ensure the proper placement of key component parts.

1. Burn Grate and Burn Pot

To help in making cleaning easier, you can remove the burn grate (B) and burn pot (A).

Remove any debris from the burn pot area. This reduces the possibility of air leaking around the bottom edges.

Line the bottom of the smoker with heavy duty aluminum foil. Re-install the pot and grate..

Ensure that the notched portion (C) of the Burn Pot (A) is pushed, tight, all the way into the side wall of the smokin grill.

Install the Burn Grate (B). The larger back lip of the grate installs under the pellet drop chute. The igniter holes should be exposed through the slot in the bottom of the burn grate. The burn grate should be a snug fit.

2. Arched Flavor Guard Level

To check for proper height, the bottom of the mounting bracket (B) should not be within the pellet drop chute area.

If you do need to adjust the bracket, loosen off the two (2) phillips screws, lift the bracket and re-tighten the screws.

The "Arched Flavor Guard" (A) then clips easily over the adjustable mounting bracket (B).

3. Grease Can Hanger

The Hanger (A) is designed to drop through the grease spout, from the inside of the barrel.

Lift the tab on the Beverage Can straight up, then the tab simply hooks onto the hanger extending.

HOW YOUR COUNTRY SMOKER WORKS 101

Your Louisiana Wood Pellet Grill combines many unique features with time proven pellet-burning technology. Together they give you perfect control, quick, savoury-and absolutely fool proof cooking results every time.

- The perfect barbeque experience starts with filling your hopper(2) with all natural wood pellets.
- Click the "Power Switch" to the "ON" position (17) this activates the "Fan" (6) used to cool the hopper (16), cause the pellets to burn and results in convective cooking.
- Pushing the "Start Touch Pad" activates the "Electronic Auto Igniter" (8) and the pellet feed systems (5).
- A motorized rubber wheel (3), delivers the pellets to the burn grate (7). Your **Louisiana Grill** uses "Top Feed" technology which means the "Feed Wheel" delivers the wood pellets up above the burn pot area and then the pellets fall down a chute in to the burn area. The flexibility of the "Feed Wheel" and the open design reduce the possibilities of "jams" and allows for the use of less than premium quality fuel.
- Adjusting the "Temperature Control Switch" (17) sets the speed of the motorized feed wheel and the temperature output.
- The "Electronic Auto Igniter" (8) activates for approximately 7 minutes, igniting the pellets in the burn grate (7).
- The combustion / cooling fan (6) provides combustion air to the burn grate as well as causes air movement in the cooking area, resulting in convection cooking (14).
- The fuel burns in the burn grate (7), hot and intense, somewhat like a forge. The fly ash is directed downward by the "Arched Flavor Guard" (12), and can be cleaned out periodically from inside the bottom of the barrel.
- The "Arched Flavor Guard" (12) also protects the food from direct flame, gives a large hot metal area to help evaporate the juices back into the cooking, channels excess grease directly to a grease pail (11), and distributes the heat evenly throughout the cooking area.
- The natural smoke flavour produced by the burning pellets, the smoke produced by the "Arched Flavor Guard"(12), and the air circulating throughout the cooking area, combine to give you that savoury flavour that is unique to pellet grills and will win you rave reviews each time you use it.

TIP Your *Country Smokin Grill* can run efficiently over extended periods of time and at different heat output levels as long as the fuel supply is uninterrupted and *timely cleaning and maintenance is performed.*



Standard Features

1. Hopper Lid
2. 8 lb. Hopper
3. Patented Paddle Wheel Feed
4. Stay Cool Handle
5. Feed Motor
6. Combustion / Cooling Fan
7. Burn Grate
8. 300 Watt Igniter
9. Burn Pot
10. Engineered Legs
11. Drip Bucket
12. "Arched Flavor Guard"
13. Cooking Grid
14. Convection Cooking Chamber
15. Dome Thermometer
16. Vented Air Cooled Hopper
17. "Louisiana" Control Board

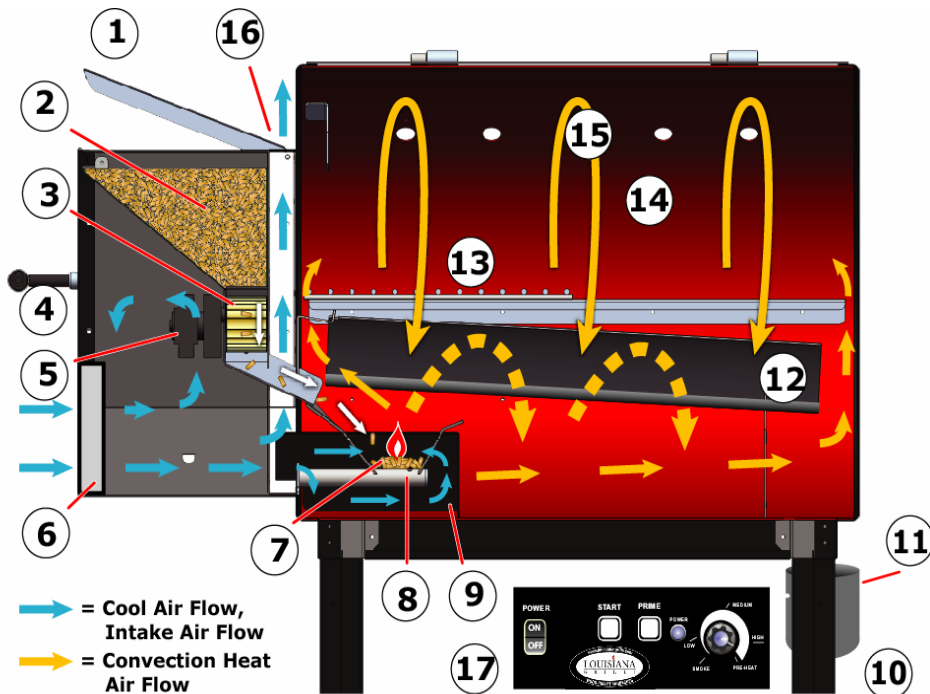

→ = Cool Air Flow, Intake Air Flow
→ = Convection Heat Air Flow



YOUR NEW TAILGATER/ RV SMOKIN GRILL

Large 8 lb. Hopper capacity
Easy to flip up top

Fan Cooled Hopper and
Feed System.

Fan forced combustion
and "Convection Cooking"

Auto Start Button & Electric Igniter
eliminates the need for
matches & starter fluids.

Full Range Temperature Control
gives range of 180 to 550+ degrees,
giving more cooking options, from
hot smoking to searing.

Dome Thermometer



14 Gauge Steel Construction

Paint Grade Finish
easy touch-up and maintenance
Custom colors.

3 Stainless Stay Cool Handles

1 peice "Arched Flavor Guard"
Reduces flare-ups, increases
smoke flavor, channels grease
to collector pail, and evenly
distributes heat.

Primer Button aids in
quicker heat recovery or
increasing smoke intensity.

Lightweight and easy to move
perfect for the RV, camping or
tailgate party.

MODEL	COOKING AREA	ELECTRIC	SIZE H X W X D	WEIGHT
TG300	308 inches of cooking surface. Can hold a 25 lb. Turkey.	110 Volt 60HZ 5 amp 3 prong grounded plug 10 amp GFI 750 watt inverter with igniter 75 watt inverter without igniter	23 X 32.5 X 19.5	72 lbs.

OPTIONS:



Stainless Steel Hood
Add that little touch of
"Class". Stainless Steel
front and top panel,
sides are paintgrade.

Clip-on Side Shelf
13"W x 18"D
Stainless open Grid
or Solid Stainless
Slide Over.

Clip-on Front Shelf
13"D x 18"W
Stainless open Grid
or Solid Stainless
Slide Over.

Cabinet Enclosure
2 swing open doors
2 side panels
1 rear panel
Stainless Steel Finish
or Paint Grade Finish

Hopper Extension
Easy add-on for those
extended smokin
times`



Engineered Legs
Turn the portable tailgater into a Freestanding unit.
This cart comes with leveling legs and wheels
Unit slips over top of the legs and then can be
secured to give you solid, sturdy construction.

Custom Cover
Embroidered, Heavy duty 600 denier,
polyester canvas, double stitched,
UV protected, Polyurethane interior.
Tightening strap.
(Fitted for side shelf option)



YOUR NEW 450, 570, 680 WOOD PELLET FIRED SMOKIN GRILLS



Large 8 lb. Hopper capacity
Easy flip up top

Dome Thermometer

Patented "Paddle Wheel"
Feed system

Fan Cooled Hopper and
Feed System.

Fan forced combustion
and **"Convection Cooking"**

Auto **Start Button & Electric Igniter**
eliminates the need for
matches & starter fluids.

Full Range Temperature Control
gives range of 180 to 550+ degrees,
giving more cooking options, from
hot smoking to searing.

Primer Button aids in
quicker heat recovery or
increasing smoke intensity.

Grease Catcher
makes clean-up and
disposal easier.

14 Gauge Steel Construction

Cold smoker ready
(add-on option)

2 Stainless Stay Cool Handles

1 piece **"Arched Flavor Guard"**
Reduces flare-ups, increases
smoke flavor, channels grease
to collector pail, and evenly
distributes heat.

Paint Grade Finish
easy touch-up and maintenance
Custom colors.

Levelling legs

Easy move wheels

**Heavy duty engineered
legs and shelf frame**

MODEL	COOKING AREA	ELECTRIC	SIZE H X W X D	WEIGHT
450	450 inches of cooking surface.	110 Volt 60HZ 5 amp 3 prong grounded plug 10 amp GFI	43 X 39.5 X 23	111 lbs.
570	570 inches of cooking surface.	Same	43 X 45 X 23	128 lbs.
680	680 inches of cooking surface.	Same	43 X 51 X 23	132 lbs.

OPTIONS:



Clip-on Side Shelf
13"W x 18"D
Stainless open Grid
or Solid Stainless
Slide Over.

Clip-on Front Shelf
13"Deep
Stainless open Grid
or Solid Stainless
Slide over.

Hopper Extension
Easy add-on for those
extended smokin
times`

**Cold Smoker
Attachment**
Attaches easily to the
already supplied side
access. Cold smoke
cheese, fish, etc.

Cabinet Enclosure
2 swing open doors
2 side panels
1 rear panel
Stainless Steel Finish
or Paint Grade Finish

Custom Cover

Embroidered, Heavy duty 600 denier,
polyester canvas, double stitched,
UV protected, Polyurethane interior.
Tightening strap.
(Fitted for side shelf option)



1050 AND THE WHOLE HOG

DUAL large 8 lb. Hopper capacity
Easy to flip up top

Removable Center Barrier
Can use as two separate Smokin Grills
or divider can be taken out to cook
that WHOLE HOG or feed a crowd
(available only on Whole Hog unit)

DUAL Dome Thermometers

DUAL Patented "Paddle Wheel"
Feed system

DUAL Fan Cooled Hopper and
Feed System.

14 Gauge Steel Construction

Stainless Stay
Cool Handles

Fan forced combustion
and "Convection Cooking"



Auto Start Button & Electric Igniter
eliminates the need for
matches & starter fluids.

DUAL Grease Catcher
makes clean-up and
disposal easier.

DUAL 1 peice "Arched Flavor Guard"
Reduces flare-ups, increases
smoke flavor, channels grease
to collector pail, and evenly
distributes heat.

Full Range Temperature Control
gives range of 180 to 550+ degrees,
giving more cooking options, from
hot smoking to searing.

Paint Grade Finish
easy touch-up and maintenance
Custom colors.

Primer Button aids in
quicker heat recovery or
increasing smoke intensity.

Leveling legs

Easy move wheels

Heavy duty engineered
legs and shelf frame

MODEL	COOKING AREA	ELECTRIC	SIZE H X W X D	WEIGHT
1050	1050 inches of cooking surface.	110 Volt 60HZ 5 amp 3 prong grounded plug 15 amp GFI	46 X 77 X 26	331 lbs.
WHS1320	1320 inches of cooking surface. Or 2 x 660 inch cooking surfaces	Same	46 X 84 X 26	347 lbs.

OPTIONS:



Clip-on Front Shelf

13"D x 58"W
Stainless open Grid
or Solid Stainless
Slide Over.

Cabinet Enclosure

2 swing open doors
2 side panels
1 rear panel
Stainless Steel Finish
or Paint Grade Finish

Hopper Extension

Easy add-on for those
extended smokin
times'

Custom Cover

Embroidered, Heavy duty 600 denier,
polyester canvas, double stitched,
UV protected, Polyurethane interior.
Tightening strap.
(Fitted for side shelf option)



STANDARD FEATURES

ARCHED FLAVOR GUARD™

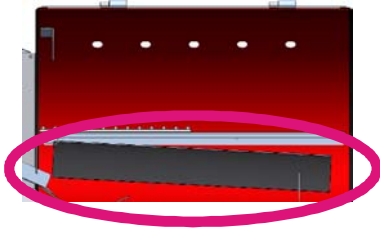

All “Country Smoker” models come with a 14 gauge “Arched Flavor Guard”, designed to withstand high temperature and give years of performance. The “Arched Flavor Guard” has been designed to keep the flame out of direct contact with your cooking surface, thus helping to reduce the chance of flare-ups. The “Arched” design increases the amount of hot surface area to allow more fats and juices from the meats to evaporate as smoke flavor, back into the meat. As well you will note the bent edges running down the length of the back and front of the angled, arched steel; these are to help in channelling the excess grease directly to the one end of the smoker where it is then allowed to collect in a convenient removable pail. The unique design of the flavour guard also directs the majority of fly ash down toward the bottom of the barrel, while allowing for the fan forced heated air to circulate around the barrel causing convective cooking.

AUTOMATIC IGNITER

The 300 watt electric igniter eliminates the need for messy starter fluids or gels. It is safe and easy to start, even the little beginner “Pit Master” can start a Country Smokin Grill. The igniter is simply a hot rod encased in a stainless steel holder. This style of igniter has been used throughout the pellet stove industry for years. The combustion/cooling fan blows air into the back of the igniter assembly and the super heated air is allowed to exit through the two holes found in the burn grate area. As the pellets begin to heat up they eventually break out in flames, this is known as spontaneous combustion. The igniter will stay activated for 7 minutes. If for any reason the igniter fails, you can start the grill manually.

NOTE: The igniter can be disconnected, to allow your country smoker to be run with a minimum 75 watt inverter. (See manual starting procedures to operate).

BURN GRATE (B)

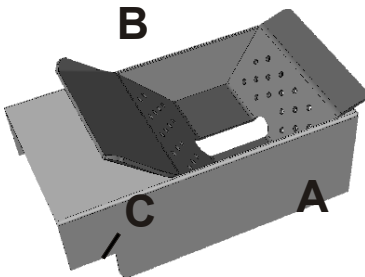

The burn grate is constructed out of stainless steel and is the heart of your grill. The burning temperature in the pot can reach temperatures of 1700 to 2000°F. The air holes are designed to allow the right combination of fan forced air to force the wood pellets to burn hot and clean while grilling or allow them to smoulder and produce the savory smoke while in the smoke mode. The bottom is notched out to allow the grate to set over the electric igniter, allowing the heated air within the ignitor casing to heat up the pellets until they spontaneously combust. **The burn grate should be checked after every major use to ensure that the combustion air holes are not clogged and to ensure the igniter holes are clean.**

BURN POT (A)

The burn pot is used to hold the “Burn Grate”, the “Igniter” assembly and to channel the fan forced combustion air. The pot has been designed to be moved easily, to aid in cleaning and replacement of the igniter. **It is very important that the burn pot is seated properly in order to ensure proper combustion and heat output.** The burn pot needs to be pushed in tightly against the side of the barrel. (c) Also ensure that there is no foreign matter under the burn pot that may lift the pot off the bottom of the barrel. This would allow combustion air to leak out again reducing the heat output of your grill. (see proper placement on page 5 of this manual).

PATENTED “PADDLE WHEEL” FEED

The heart of the feed system is a rubberized “paddle wheel”. This wheel is highly flexible thus allowing different quality of pellet fuels to be used while reducing the possibility of “jams” taking place. The paddle design also helps in maintaining a constant and even feed of the fuel to the fire resulting in better and consistent temperature control. The “paddle wheel” is run by a 1 rpm motor and is timed to operate for three seconds. (see control board for further information).

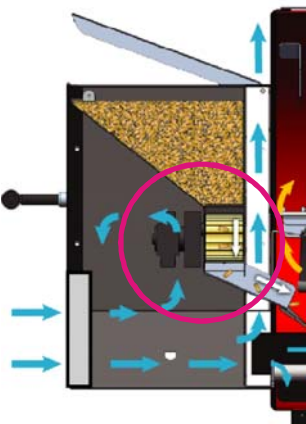

STANDARD FEATURES cont...

CONTROL PANEL

Board Features

Power Switch

Used to turn both the power “ON” and the combustion / cooling fan. Also activates the “Shut Down” of the smokin grill.

START Touch Pad

Used to activate the “Start Up” mode. The “Paddle Wheel” feed system will begin to operate, the Power LED will illuminate blue, and the Auto Igniter will begin to glow.

PRIME Touch Pad

When this touch pad is pressed and held, the Fuel Feed system will turn and feed more pellets to the burn grate. This can be used to add more fuel just before opening the grill lid, to help with quicker heat recovery. It can also be used to add more fuel while smoking, to increase the smoke intensity.

POWER LED

Will illuminate blue when the Power Switch is on and the Start touch pad has been pushed. It will continue to illuminate until the Power switch has been pushed OFF and the board has completed the automatic 15 minute Shut Down mode.

FEED POTENTIOMETER or Temperature Control

Used to control the frequency the Paddle Wheel feed system feeds pellets to the burn grate, thus effecting the heat and smoke output. The Feed Potentiometer is NOT active when the grill is in the 7 minute Start Up mode, giving you the ability to set it at PREHEAT while ensuring proper ignition.

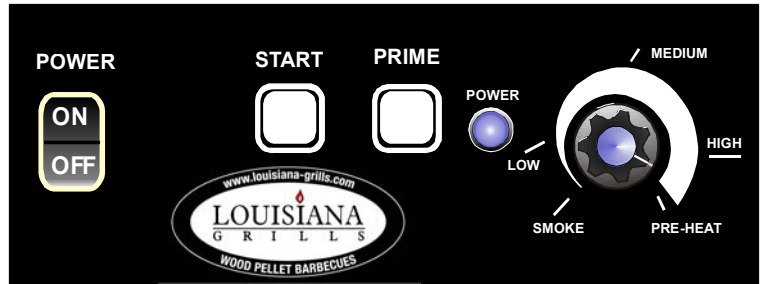

How the Board Works 101



START UP Mode

Upon turning the Power switch to the “ON” position, setting the Feed Potentiometer to the PREHEAT position and then pressing the Start touch pad, the board will activate the Start Up mode. Start Up will start the combustion / cooling fan, the feed system and the igniter. The Start Up mode will last automatically for 7 minutes and the feed rate is factory set by the control software program.

OPERATING Mode

After the Start Up mode is complete, the Feed Potentiometer is fully functional. The feed system is designed to feed fuel for 3 seconds then stop feeding at preset times managed through the potentiometer. The “Off” times range from 35 seconds for “Smoke” to 3 seconds for “Preheat”. Because the all natural wood pellet fuel is dry and consistent, it is easy to keep a close to constant temperature.

NOTE: Keep in mind that all Louisiana Wood Pellet Grills are designed to operate with the lid closed and that the external temperatures, wind, rain, and humidity will effect cooking times and heat output.

SHUT DOWN Mode

When finished “Savoring the Flavor” simply push the Power Switch to the “OFF” position. The control will begin a 15 minute cool down cycle by stopping the Paddle Wheel feed system from running, while keeping the Combustion / Cooling fan running to cool the grill. If you do find more food to grill or bake, you can turn the Power Switch to the “ON” position within the first 3 minutes and the grill will continue to operate as normal. If you miss the 3 minute window, you must go through the Start Up Mode again.

STANDARD FEATURES CONT ...

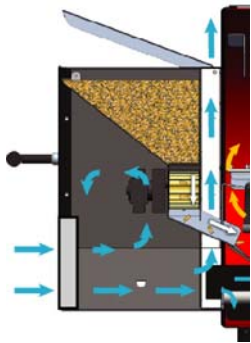

“FAN COOLED HOPPER”

The entire line of Country Smokers utilizes the exact same Hopper and component parts. To increase the life of your grill and its main working component parts the Combustion / Cooling fan is used to perform 3 main functions:

1. Pressurize the internal hopper compartment to cool the wiring and electrical component parts, the “Paddle Wheel” feed system and the wood pellet fuel.
2. Forces constant air movement between the hopper and grill barrel wall. Because of the higher temperatures needed for searing and because of the longer length of time a pellet grill can operate, to slow smoke a whole hog, air movement is used to provide a barrier between the two surfaces. Note the air slots found at the top of the hopper, between the lid and the grill. **Ensure that these do not get blocked off at any time.**
3. To provide combustion air allowing the pellet fuel to burn properly. The fan forced air is then used to provide “Convection Cooking” within the smokin grill. Convection cooking locks in the juices and distributes the heat evenly throughout the grill resulting in that savory flavour and near perfect cooking.

PAINT GRADE FINISH

Louisiana Grills uses a “High Heat BBQ Paint” finish throughout the entire line of Country Smokers. This is done to allow easy and trouble free maintenance, adding to the life and look of your smoking grill. Baked enamel and porcelain finishing require as much, if not more, maintenance and up keep. If they do scratch or chip and moisture gets between the surface and the exposed metal, the problem becomes even larger. “Surface Rust” and “Food Acids” are two of the most common factors that effect your smokers finish. Surface rust can develop for a number of reasons; such as pets, kids, accidents, weather, etc. Acids that are found in many common foods and meats can also act as a corrosive on most finishes. A paint grade finish may require a periodic sanding and a touch-up painting once a season to maintain that just new appearance. Louisiana Grills uses a Black color, “Stove Bright” brand, High Heat BBQ Paint. This can be purchased from your local dealer or through Louisiana Grills. This paint is a silicone epoxy base and is designed for up to 1100°F (600°C). Paint Grade allows flexibility in the color you may desire to match the decore of your cooking area or your favorite team. A good quality grill cover is a great investment in keeping your grill looking good and lasting longer. (see maintenance for further details)



PORCELAIN COATED COOKING GRIDS

Your Country Smokin Grill comes complete with porcelain coated cooking grills or grids, as they are called by the “Pit Masters”. Porcelain grids may not have the same heat retention as cast iron, but they do show “grid marks” and are never easy to clean. To maintain the searing and grilling performance of your grid, as well as their longevity, some special care and maintenance is required.

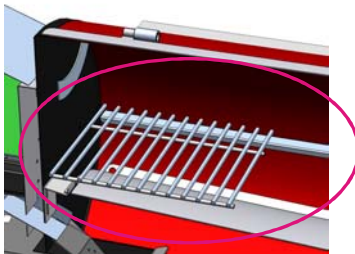

GREASE CATCHER

All Country Smokers use the “Arched Flavor Guard” system that channels any excess grease, that does not evaporate, directly to a sealed grease catch area. From here any excess grease is directed to the drop spout where it is disposed in an easy to replace, low cost soda or beverage can of your choose. The can is hung in place using the J style hook that is mounted through the grease spout. Simply by lifting the pull tab from the beverage can, upwards, allows the can to easily hook on to the J hook. Allow the grease to cool before removing the can or for those extra fatty foods, you may need to replace the can while using the smoker. If this is the case be sure to wear an oven or bbq glove, as the can will be hot and cause burning.

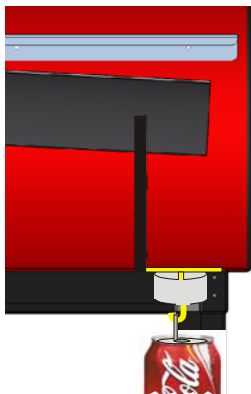

ABOUT WOOD PELLETS



They are no thicker than the eraser on the end of a pencil, people who see them for the first time think they look like rabbit food, but there is nothing small about the heat energy in a wood pellet. These clean burning wood pellets generate about 8200 BTU's per pound with very little ash and low moisture content.

Barbeque wood pellets are produced in the same matter as wood pellet fuel is produced for home heating. Pure raw material (sawdust) is pulverized with a hammer mill and then dried. The dried material is then processed under heat and pressure. Lignin, which is the natural glue, which holds plant fibre together, softens above 100° C, permitting the material to change shape. The hot lignin then acts like a binding agent to bond the pellet together. The heated material then goes through a hard steel die, much like a meat grinder, which rotates against rollers forcing the material through the die with pressure over 3 000 PSI. As the pellet is forced through the die it is sheared off at a specific maximum length, cooled, screened, vacuumed, and then bagged into 10, 20 or 40 lb bags.

General specifications for barbeque pellets are: 100% pure hardwood, no additives, 1"long or less in length, 1/4" diameter, less than 2% ash content, less than 2% fines, under 10% moisture content, approx. 8200 BTU's per lb. and about 40 lbs per cubic ft. density.

WARNING! Using other brand Barbecue Pellets may only enhance your grilling experience. (and will not void your warranty)

Mesquite, from the Aztex "mizquiti" (which means "the honey tree"); true to its name gives a delicate, subtle, sweet flavour to grilled foods- especially good with poultry and seafood.

Hickory intensifies the flavour of food with a robust, tangy taste that is better suited to red meat than to poultry and fish.

Apple or fruitwoods, many from orchards destroyed by fire or old age, are a big hit. Like its mesquite counterpart, the heaviest branches of the apple tree is heated to kill insects, then chipped, made into pellets, and packaged for retail. Apple or any fruitwood, adds a mild sweetness to everything that you cook and is highly recommended for any baking.

	Beef	Buffalo	Lamb	Pork	Poultry	Fish	Vegetables	Baking
Hickory	x	x		x	x		x	
Mesquite	x	x			x	x	x	
Alder	x	x	x	x	x	x	x	x
Apple				x	x		x	x
Cherry	x	x	x	x	x			x
Orange				x	x			x
Pecan	x	x	x	x	x	x	x	x
Oak	x	x	x			x		
Maple	x	x	x	x	x	x	x	x

Be brave, think outside the bag, try different varieties or mix them together to customize your blends.

Check our website www.countrysmokers.com for other barbecue pellet manufactures.

TIP Always store your pellets in a dry area. Avoid any contact or exposure to moisture. This will cause the pellets to absorb the moisture and will result in lower BTU output or the pellets to swell and break apart. Use a moisture proof re-sealable tub or bucket.

- Mesquite
- Hickory
- Alder
- Oak
- Apple
- Cherry
- Pecan



SET UP PROCEDURE

Please note that during shipping some movement may have taken place, so a complete visual inspection is required. Please follow these Initial Set-up procedures to insure the proper and safe operation of your grill.

Note: Do not plug your grill into an electrical outlet until this procedure is complete.

TIP It is a highly recommended practice to always go through these basic SET UP PROCEDURES after every 1 to 3 cookings. This will ensure proper ignition, heat output and many continuous happy grilling experiences.



Open the SMOKER LID and remove the Cooking Grids (13). "Tailgate" comes with 1 grid, the "450", "570", "680", "1080" and "Whole Hog" models come with 2 sections.

Remove the "Arched Flavor Guard" cooking surface (12). The "U" shape sits upside down to help distribute the heat and to keep fly ash to a minimum. The flame deflector also keeps the flame from making direct contact with your cooking.

Remove the stainless steel burn grate (7) and check the burn pot (9) area, remove any foreign items. Ensure that the air holes in the grate (7) and the igniter (8) are clear of debris.

You can line the bottom of the Smokin Grill with heavy-duty aluminium foil. Line from left to right, starting under the burn pot (9) area and going to the grease stop. This will make clean-up and general maintenance easier.

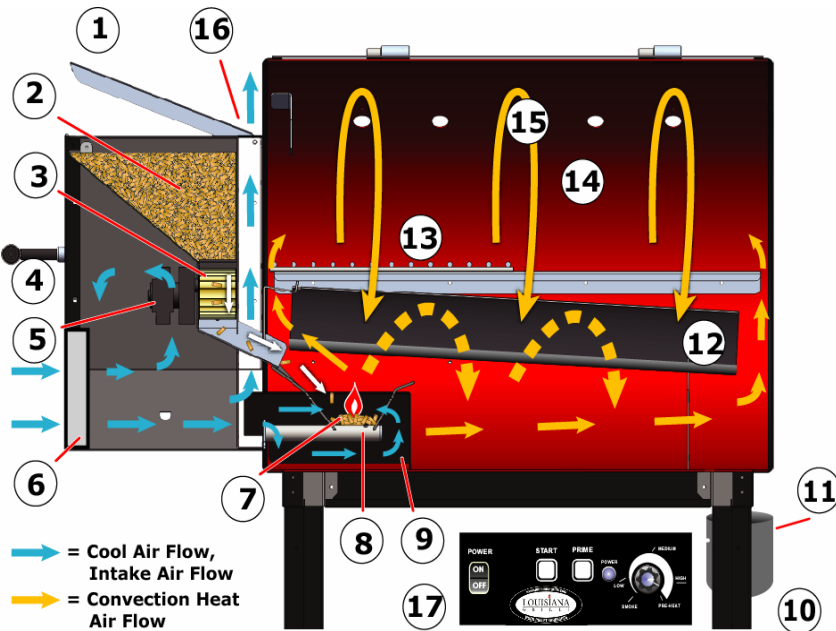

Install the Catch Bucket Hanger and Bucket (11)

Re-install the burn pot (9). Ensure that the pot is sitting snug to the bottom of the barrel and that it is slid all the way into the side of the barrel opening.

Next re-install the burn grate (7). Ensure that the stainless steel grate is setting down and snug in the burn pot with the two igniter holes (8) visible and clear of obstructions.

Re-install the "Arched Flavor Guard" (12). This mounts back on the side bracket located on each side of the burn area. The opening of the "U" shape should be facing downwards. One end of the Flavor Guard (12) does have a slot cut into it. This hooks over the moveable hanging bracket found over the pellet drop chute area. You may want to line the Arched Flavor Guard with heavy duty aluminium foil, again to aid in clean-up.

Reinstall the Cooking Grids (13).

Open the Pellet Hopper Lid (1), found on the side of your Smokin Grill. Check for any foreign objects.

Fill the hopper(2) with your choice of all natural wood pellet fuel. Close the hopper lid.

Plug your "Country Smoker" into the nearest grounded 110 volt AC outlet, minimum 5 amp. (10 amp for dual hoppers)

You are now ready to push the Power Switch (17) and Start touch pad to enjoy that savory taste of pellet convection cooking.



GETTING STARTED

With today's lifestyle of striving to eat healthy and nutritious foods, one factor to consider is the importance of reducing fat intake. One of the best ways to cut down on fat in your diet is to use a low fat method of cooking, such as grilling.

Throughout this manual, you will notice the emphasis on grilling food slowly at MEDIUM temperature settings. Because of the benefit of convection cooking, and the use of the "Arched Flavor Guard", your Country Smoker Grill will enable you to avoid flare-ups and maximize the nutritional value of the foods that you cook.

Following is a list of the important tips that will contribute to the cooking perfection that you can expect when using your Louisiana Grill.

Environment

As with all barbecues, the outside weather conditions will play a big part in the performance of your Country Smoker and the cooking times needed to perfect your culinary delights. Your Country Smoker, because of its single wall construction, should be considered as a 2 to 3 season grill, depending on what part of country you live in. For greater detail on grilling and weather conditions, see the "Hot and Cold" weather tips found in your Louisiana Grills Cook Book and Recipe Keeper.

Grill Placement

The tailgate model should always be placed on a non-combustible surface when using the grill without the leg option.

All Country Smokers should always be a minimum of 12 inches away from any wall behind the grill. Your grill does come with wheels or casters so the smoker and vent holes found on the back, can be turned away from the wind resulting in better temperature output. If you are able to shelter your grill from the wind this will aid in temperature output, heat retention, and heat recovery time when opening the lid.

Operating the Grill

Initial Burn Off

Before cooking on your smoking' grill for the first time, we recommend that you "burn off" the grill to rid it of any foreign matter. Light and operate the grill on PRE-HEAT with the lid down for 30 – 40 minutes.

Lighting your Grill

It is recommended practise to always go through the SET UP Procedures after every 1 to 3 uses. This will ensure proper ignition and many happy grilling experiences. Light as per instructions found in detail later in this manual. If the grill fails to light, this is most likely due to a dirty or full burn grate blocking the auto igniter air passages. (refer to lighting instructions found elsewhere in this manual)

Should your auto igniter refuse to ignite the wood pellets, it is easy to light your grill manually with a match and lighting agent. (refer to manual lighting instructions found elsewhere in this manual)

Pre-Heating

It is extremely important to ALWAYS allow your grill to preheat before cooking. This allows the grill and cooking grids to heat up quicker and the grill is able to maintain its cooking temperature once your food is placed in the cooking area. If you do not allow the grill to preheat, you will find that it takes a longer period of time to bring both the grill and the food to cooking temperatures.

Always pre-heat your Louisiana Grill with the lid closed. Set your control knob to PREHEAT, after ignition and the automatic start of 7 minutes, allow the "Smokin Grill" to preheat for 10-15 minutes depending on weather. This gives you enough time to prepare your food for the grill; as well it is the final step in cleaning your cooking grids.

Lid Position

Always cook with the lid closed. Not only does this keep the temperature even, the food will cook faster, using less fuel. A closed lid also helps to create a smokier flavour. You can slow down your cooking by propping up the lid using the grill lifter.

CAUTION: Grease fires are caused by not properly maintaining your grill, or failing to clean the bottom of the barrel on a consistent basis. In the unlikely event you experience a grease fire while cooking, keep the lid closed. If it does not go out in a very short time, open the lid and lightly sprinkle baking soda on the fire. Be careful not to burn yourself. If this does not work, then carefully remove the food from the grates, turn the temperature control to OFF and shut the lid until the fire is completely out.



GETTING STARTED CONT...

NOTE: The temperature settings on the control board are not accurate! Due to environment, fuel and cooking conditions, the settings are only for reference!

Cooking Settings

Pre Heat

The **PREHEAT** setting will give an oven temperature of over 500 to 600°F (316°C), depending on weather conditions. This setting is used to quickly preheat your grill as well as to finish the cleaning cycles for the cooking grids and the “Arched Flavor Guard”. Could also be used as a **HIGH** setting in extreme cold weather conditions or if cooking with the lid open.



High

The **HIGH** setting will give an oven temperature of approximately 450°F – 550°F, depending on the weather. This setting is ideal for quickly searing steaks, hamburgers and chops.

Medium

The **MEDIUM** setting will give an oven temperature of approximately 350°F (177°C) when the lid is closed and the weather conditions permit. This setting is recommended for finishing cooking steaks, hamburgers, chops, etc. Excellent for baking. This setting is also used to **IGNITE** your Louisiana Grill, automatically. This setting allows just enough pellets to feed and the proper air to transfer heat from the igniter to start the wood pellet fuel.

Low

The **LOW** setting will give an approximate oven temperature of 250°F to 350°F (154°C – 177°C). Used to prolong cooking times or just to warm-up your left over master pieces.

Smoke

The **SMOKE** setting will give an approximate oven temperature of 180°F to 220°F. This setting is used to slow roast and to increase the smoke flavour of your favourite food. Highly recommended for that **BIG BIRD** at Christmas, Easter, Thanksgiving, Birthdays, and all other important holidays.

Smoking is a variation on true barbecuing and is truly the main advantage of grilling on a wood pellet grill. There are two types of smoking: **HOT** smoking and **COLD** smoking. **HOT** smoking, just another name for barbecuing, is generally done at 200 to 250°F. **COLD** smoking is where the food is located so far away from the fire that it smokes without cooking. Your “Louisiana Grill” is classified as a **HOT** smoker.

Hot smoking works best when a longer cooking time is required, such as large cuts of meat, fish, or poultry, Experiment with the length of time you leave for smoking, before cooking thoroughly. Some chefs prefer to smoke at the end of cooking and to keep the food warm until ready for serving. Remember practice makes perfect.

TIP The temperatures listed above are all approximate and will be affected by the outside temperature, the amount and direction of wind present, the length and type of pellet fuel being used and the number of times the lid is opened.



After Cooking

One of the greatest benefits of your Louisiana Grill is the minimal clean up required. When you are finished cooking and waiting just a little while to let the flavor set in that prime selection of meat, we recommend the following:

1. Using a long handled grill cleaning brush to remove any food or build up from the cooking grids, while it is still warm.
2. Turn the control knob to **PREHEAT** for 5 minutes. Let the grill heat up, then push the **POWER** button to the “**OFF**” position and you’re **DONE**.
3. A quick wipe up of the stainless steel counter top, using a cloth and mild soap, let the unit cool and put your Louisiana Grill to bed with the optional **GRILL COVER**.

TIP To intensify that savory smoke flavor, switch to smoke mode immediately after putting your food on the grill. This allows the smoke to penetrate the meats before they have a chance to sear closed.



LIGHTING YOUR COUNTRY SMOKER

NOTE:

Always clean your burn grate before each use. This will ensure proper ignition, heat output and many continuous happy grilling experiences.

Automatic Start Up

1. Ensure the POWER switch is in the "OFF" position.
2. Plug the POWER CORD into a 110 Volt grounded outlet. DO NOT break the ground end off the cord or use a non-grounded outlet or extension cord.
NOTE: When plugged into a GFI ensure it is at least 10 amps.
Lower quality GFIs may trip when using this appliance.
3. Open the HOPPER LID. Ensure there are no foreign objects in the hopper or "PADDLE WHEEL" feed system. Fill hopper with all natural flavoured wood pellets.
4. Turn the FEED CONTROL (temperature output) to the "PREHEAT" position.
5. Switch the POWER switch to the "ON" position.
 - This will start the combustion/cooling fan.
6. Press the START touch pad.
 - This initiates the start up cycle, which includes; the feed system will start to turn, the igniter will begin to glow and the power indicator will illuminate.
 - The Country Smoker now begins an automatic 7 minute "Starting Procedure"
 - The Feed Rate is pre-programmed to ensure proper ignition.
 - Your grill will begin to produce smoke while the start up cycle is taking place. Close the lid.
 - The pellets have ignited once the smoke has cleared. To check open the lid of your grill and a flame will be visible in the burn pot area. You will be able to view this without having to touch any hot surfaces.
7. Turn the FUEL FEED to PREHEAT, if not done already, and allow unit to preheat for approximately 15 to 20 minutes.
CAUTION: If excessive flame is visible i.e. "Arched Flavour Guard" is glowing bright red, turn the FEED CONTROL down.
8. After the pre-heating is complete you are now ready to enjoy your grilling experience.

NOTE: Different wood pellets will produce different temperatures; as well the outside temperature and weather conditions will also affect your cooking temperature. The markings on the CONTROL LABEL are approximate.

NEVER add pellets by hand to a hot fire pot. This is dangerous and you may get seriously burned. If you do run out of fuel and you lose your fire while cooking, Re-fill the hopper and go through the normal LIGHTING procedure.

NOTE: If the fire does not start, the Country Smoker will continue to feed pellets. If this happens, some unburned pellets will build up in the burn grate. To restart the fire, clean the excess pellets out of the burn grate and follow the above steps.



LIGHTING YOUR COUNTRY SMOKER CONT...

NOTE:

Always clean your burn grate before each use. This will ensure proper ignition, heat output and many continuous happy grilling experiences.

Manual Start Up

If for any reason your electric igniter fails, you can start your "Country Smoker" manually.

1. Ensure the POWER switch is in the "OFF" position.
2. Plug the POWER CORD into a 110 Volt grounded outlet. DO NOT break the ground end off the cord or use a non-grounded outlet or extension cord.
3. Open the HOPPER LID. Ensure there are no foreign objects in the hopper or "PADDLE WHEEL" feed system. Fill hopper with all natural flavoured wood pellets.
4. Remove the COOKING GRIDS and "ARCHED FLAVOR GUARD" to expose the BURN GRATE AND BURN POT.
5. Place two generous handfuls of pellets into the BURN GRATE.
6. Squirt gelled fire starter, or other approved pellet starter, over the top of the pellets or Add a small amount of solid fuel fire starter, such as those made from sawdust and wax or use wood shavings. Add a small amount of pellets over the fire starter.
7. Light the starter using a long fireplace match or long lighter.
WARNING: NEVER ATTEMPT TO ADD MORE STARTER INTO A FIRE THAT IS ALREADY BURNING OR INTO A HOT BURNGRATE. YOU COULD EXPERIENCE A BURN BACK AND YOU COULD GET SERIOUSLY BURNT.
8. Allow the starter to burn for 3 to 5 minutes.
9. Quickly and carefully replace the "ARCHED FLAVOR GUARD" and the COOKING GRIDS.
10. Turn the FEED CONTROL (temperature output) to the "PREHEAT" position.
11. Switch the POWER switch to the "ON" position.
This will start the combustion/cooling fan.
12. Press the START touch pad.
This initiates the start up cycle, which includes; the feed system will start to turn and the power indicator will illuminate.
The Country Smoker now begins an automatic 7 minute "Starting Procedure"
The Feed Rate is pre-programmed to ensure proper ignition.
Your grill will begin to produce smoke while the start up cycle is taking place. Close the lid.
The pellets have ignited once the smoke has cleared. To check open the lid of your grill and a flame will be visible in the burn pot area. You will be able to view this without having to touch any hot surfaces.
13. Turn the FUEL FEED to PREHEAT, if not done already, and allow unit to preheat for approximately 15 to 20 minutes.

CAUTION: DO NOT USE ANY FLAMMABLE LIQUIDS SUCH A GASOLINE, GASOLINE-TYPE LANTERN FUEL, KEROSENE, CHARCOAL LIGHTER FLUID, OR SIMILAR LIQUIDS TO START OR FRESHEN-UP THE FIRE! KEEP ALL SUCH LIQUIDS WELL AWAY FROM THE GRILL WHILE IT IS IN USE.



SHUTTING OFF YOUR SMOKER

Your Country Smoker will give you many years of flavorful service with minimum cleaning. An important step is allowing the grill and cooking grids to “Self Clean” by running the grill on high temperature for 5 – 10 minutes after each use.

When finished cooking on your Louisiana Grill turn the FEED CONTROL switch to the “Pre Heat” position. Let your grill run for 5 – 10 minutes to go through its normal cleaning method. If you have been preparing meats that are extra greasy, it is a good practise to allow the grill to burn for an extra 10 to 20 minutes. This will reduce the chances of “Flare-Up” while preparing your next savory meal.

When complete, simply push the Power switch to the “OFF” position. Your Country Smoker will begin its automatic Shut Down procedure. The patented “Paddle Wheel Feed” system will stop feeding fuel, the flame will burn itself out, and the combustion / cooling fan will continue to run for a 15 minute period. When procedure is complete the Fan and the Power LED will turn off.

If you do find more food to grill or bake, you can turn the Power Switch to the “ON” position within the first 3 minutes and the grill will continue to operate as normal. If you miss the 3 minute window, you must go through the Start Up procedure again.

GRILL MAINTENANCE

There are two extremes when it comes to keeping the grill clean. Those that must spit and shine the entire grill, in and out, after every use, and those whom are convinced that cleaning only takes away from that barbecue flavor. One simple rule; everything in moderation.

TIP *Be diligent in you cleaning and maintenance program. Taking care of your grill will add years of life to it and keeps it looking great.*



STARTING THE SEASON OUT RIGHT

A little time and effort at the beginning of the season will not only help extend the life of your grill but will also ensure the reliability of it, and make you look like the “King or Queen of the Grill”! Most of the cleaning techniques are below. Check with your local dealer, they may provide a yearly maintenance program and inspection service.

STAINLESS STEEL WORKING SURFACES

ALWAYS clean dirt and dust off all stainless steel surfaces before you begin to cook. The dirt can cook into the metal and discolour it. These can be easily cleaned with hot soapy water and a soft cloth. A quick swipe of “Stainless Steel Cleaner” and a soft rag will also work, but you must be careful not to apply it to the painted surfaces or interior parts. With the popularity of stainless steel appliances increasing, there are now many commercial products made to clean and protect stainless steel surfaces.

PAINT GRADE SURFACES

Paint and maintaining painted surfaces are not covered under warranty. This is part of the general maintenance and upkeep.

Be sure to preheat the unit for a least 30—40 minutes before using for the first time. This allows the paint to cure and allows the new paint smoke and smell to burn off. Once cured it can be washed with hot soapy water. Do not use oven cleaner, abrasive cleaners or abrasive cleaning pads on the outside surfaces.

We use “Stove Bright” brand, Hi-Heat Black BBQ Paint.. Stove Bright also makes many more colors in high-heat stove paint, if you ever wanted to change the color to match the décor or favorite team.

To help maintain your finish, follow these easy steps:

1. Wipe your smoker down with a warm, soapy damp cloth after each use.
2. Keep your smoker covered when its not in use. Purchase a Louisiana Grill heavy duty cover from your local dealer.
3. If you do have areas that need attention, we recommend:
 - A. Clean the surface with a mild degreaser and hot soapy water.
 - B. Remove any loosened paint with a fine sand paper or wire brush..
 - C. Wipe off all loose grit with a clean rag.
 - D. Apply thin coats of touch up paint. Paint dries tack free in 20 minutes and to handle in 30 minutes.

GRILL MAINTENANCE cont...

COOKING GRIDS

When new, wash thoroughly with warm soapy water, place back in the smoker and “Preheat” the grill for 20 to 30 minutes.

After the completion of grilling, open the lid and with a long handle grill cleaning brush, give the grids a thorough cleaning. If you do not have a cleaning brush use long handle tongs and a balled up piece of aluminium foil wrap. Next turn the grill to “high” or “preheat” until only an occasional wisp of smoke is seen (about 5 minutes). This will remove most of the material that builds up on the cooking grids.

The next time you grill allow the smoker to preheat for 10 – 15 minutes to complete the cleaning cycle. Give the grids a quick wipe down with your cleaning brush. Applying a thin coating of oil on the grids before placing your meat on them will also decrease your cleaning time, as well as allowing to move your food easily without sticking and tearing.

COVER-UP

Your Louisiana Grill cover will help in protecting your grill from the detrimental effects of weather and outside pollutants. As with any outdoor product, however, a cover is only as good as the maintenance given to the grill. Following the recommended maintenance included in this manual will add greatly to the life of your grill.



Helpful Hints

DO's

- Keep your Country Smoker cover clean. This is your best protection against mildew which will form on any dirt or foreign material allowed to accumulate on tops or bottoms of fabric. Use a cleaner such as Armor-All, or a product that will not only clean but also protect.
- Have any small tears or punctures repaired promptly.
- Keep away from pets.
- Keep all shrubs and vines away from your grill cover as many plants contain acids, which harm fabrics.

DO NOT

- Cover your grill while the grill is still hot
- Store anything on the top of your grill cover.
- Permit leaves, twigs or other organic debris to remain on the cover for long periods of time
- Use high-pressure hoses or steam to clean.
- Use wire or stiff brushes, harsh detergents, abrasive cleaners or chlorine on your grill cover.

“ARCHED FLAVOR GUARD”

This requires very little work, because of its construction and the type of material used. From time to time you may need to brush off any burnt leftover. The best time to clean and inspect is when you perform the initial set-up procedures after every 1 to 3 uses.

To speed up cleaning we recommend that you line the Arched Flavor Guard with aluminium foil. This foil should be replaced after each use.

The grease channels do need to be cleaned from time to time to eliminate build-up and allow the grease to flow freely to the grease catch area.

THE COOKING BARREL

To start the season right, then maybe 2 to 3 times during the grilling season, it is recommended to remove the Arched Flavor Guard, Burn Grate and Burn Pot, to remove any ash build-up or burn debris that has accumulated. Make sure the grill is COMPLETELY COLD before using your shop vacuum or before scooping out and disposing of the ashes.

You may want to use hot water and a de-greaser to clean the entire inside of the barrel. This does reduce grease build-up and the possibilities of flare ups.

To aid in cleaning, it is recommended to line the bottom of the barrel with aluminium foil. Starting tight from the burn side of the barrel to the grease catch area. Then re-install the Burn Pot and Burn Grate.



GRILL MAINTENANCE CONT...

BURN POT

The proper seating of the burn pot is crucial to proper grill performance. The Burn Pot placement should be checked after every burn or after the grill has been moved. Because the burn pot is used to channel the fan forced air into the burn grate, there is very little maintenance to be done in this area. Occasionally you may either vacuum or brush out any build-up of ash or burn debris that has fallen below the burn grate. Before replacing the burn pot always clean any debris from around or under the burn pot seating. **It is crucial that the burn pot is seated tight to the side wall and that it is tight to the barrel bottom.**

STAINLESS STEEL BURN GRATE

Periodically check the air holes found in the sides and bottom of the burn grate for any blockages or build-ups. Using a wire brush or flat-head screwdriver, scrape off any build up or blockage. When reinstalling the grate also confirm the proper positioning in the burn pot. The grate should be level from side to side and from front to back as well as should have a snug but not tight fit. The grate should not be blocking the two igniter holes.

IGNITER

The 300 watt electric igniter needs very little maintenance. Do check to confirm that the two air holes are free of debris or blockage. As well confirm that the igniter is setting level in the burn grate.

FAN COOLED HOPPER ASSEMBLY

BE SURE TO UNPLUG YOUR GRILL BEFORE PERFORMING ANY SERVICE.

There are a number of very quick checks that should be performed on the outside of the hopper assembly.

1. Check and clean any debris from the fan air intake. E.g. Spider webs, tree fluff, etc.
2. Check and clean any debris from the air vent exhaust found at the top of the hopper.
3. Inspect and clean the fuel hopper area. The galvanized metal can be wiped down using warm water and detergent. To aid in protecting the metal and to allow the pellet fuel to slide easily, you can apply a coating of car wax .
4. Inspect the rubber "Paddle Wheel" feed wheel. Check for any tears or wearing of the wheel.

You can remove the 6 (six) Phillip screws securing the side panel to the hopper assembly. 2 on the front, 2 on the back side and 2 on the under side. This will allow you to perform the following within the hopper assembly:

1. Check and clean any debris within the hopper housing.
2. Check and clean any debris from the fan blades or housing.
3. Check and clean any debris from the feed wheel motor.
4. Visual inspection on the wire harness and all wire connections.

Upon inspection replace all 6 Phillip screws. Hand start each screw to ensure proper threading.

GREASE CATCH AREA AND CAN

Always be sure the grease catch area is clean and free of debris. We recommend the use of your favorite beverage can as the grease collector for the following reasons:

1. Clean and easy disposal.
2. The upper lip of the can contains the grease drippings.
3. The can be replaced more frequently.
4. Can be replaced easily with another can while the grill is operating.
5. Note: The can and grease will be hot. Use protection when replacing while hot.

During the warmer months empty any grease build-up on a more frequent basis to avoid it from going rancid and to avoid having any extra creatures enjoying your grill.

Slowing Down . . . Not Putting Away for the Season

We recommend that at least once a month, while your grill is cold, that you should perform not only the above maintenance procedures, but also include the following:

Using a stiff vegetable brush knock-off any built-up scale on the inside walls of your grill. Check the inside of the lid, the smoke deflector, and the inside walls of the cooking area.

Using an old paintbrush, brush off any ash build-up found inside the firebox, grate, and flame deflector areas.

Finally give your entire grill a good cleaning with a shop vac when cool to the touch, a quick wash and rinse and apply any touch up paint.

LIMITED WARRANTY



The "Louisiana Grill" wood pellet barbecue line, manufactured by Dansons Group Inc. (DGI), carries a five (5) year limited warranty for from the date of sale to the original owner only, against defects and workmanship on all steel parts, (excluding the burn grate), and three (3) years on electrical component parts only. There is no specific warranty on the paint, burn grate, grill cover and all gaskets or against damage caused from corrosion.

Conditions of Limited Warranty

1. During the term of the limited warranty, DGI's obligation shall be limited to furnishing a replacement for covered, failed components, F.O.B. point of shipment. As long as it is within the warranty period, DGI will not charge for repair or replacement for parts returned, freight prepaid, if the part(s) are found by DGI to be defective upon examination. DGI shall not be liable for transportation charges, labor costs, or export duties. Except as provided in this CONDITIONS OF WARRANTY paragraph, repair or replacement of parts in the manner and for the period of time stipulated hereunder shall constitute the fulfillment of all direct and derivate liabilities and obligations from DGI to you.
2. The warranty coverage begins on the original date of purchase and proof of date of purchase is required to validate the warranty.
3. Repair or replacement of the "Louisiana Grill" part does not extend the limited warranty beyond the five (5) years or three (3) years from date of purchase.
4. The pouring of liquids on your grill flame will void this warranty.
5. DGI takes every precaution to utilize materials that retard rust by using high-temperature paint where advisable. Even with these safeguards, the protective coatings can be compromised by various substances and conditions beyond DGI's control. High temperatures, excessive humidity, chlorine, industrial fumes, fertilizers, lawn pesticides and salt are some of the substances that can affect paint and metal coatings. For these reasons, the limited warranties DO NOT COVER RUST OR ALUMINUM OXIDATION, unless there is loss of structural integrity on the grill component. Should any of the above occur, kindly refer to you Instruction Manual's maintenance section for paint finish protection. DGI recommends that you purchase a DGI full-length protective cover, and cover your grill when not in use.
6. The warranties are based on normal domestic use and service of the grill and neither limited warranty coverage apply for a grill, which is used in commercial applications.



LIMITED WARRANTY

Exceptions to the Limited Warranty

There is no written or implied performance warranty on “Louisiana Grills” appliances, as the manufacturer has no control over the installation, operations, cleaning, maintenance or the type of fuel burned.

This limited warranty will not apply nor will DGI assume responsibility if your appliance has not been installed, operated, cleaned and maintained in strict accordance with the manufacturer's instructions. Burning other than quality wood pellets may void the warranty. The warranty does not cover damage or breakage due to misuse, improper handling or modifications.

NEITHER THE MANUFACTURER, NOR THE SUPPLIERS TO THE PURCHASER, ACCEPTS RESPONSIBILITY, LEGAL OR OTHERWISE, FOR THE INCIDENTAL OR CONSEQUENTIAL DAMAGE TO THE PROPERTY OR PERSONS RESULTING FROM THE USE OF THIS PRODUCT. ANY WARRANTY IMPLIED BY LAW, INCLUDING BUT NOT LIMITED TO IMPLIED WARRANTIES OF MERCHANTABILITY OR FITNESS, SHALL BE LIMITED TO ONE (1) YEAR FROM THE DATE OF ORIGINAL PURCHASE. WHETHER A CLAIM IS MADE AGAINST THE MANUFACTURER BASED ON THE BREACH OF THIS WARRANTY OR ANY OTHER TYPE OF WARRANTY EXPRESSED OR IMPLIED BY LAW, MANUFACTURER SHALL IN NO EVENT BE LIABLE FOR ANY SPECIAL, INDIRECT, CONSEQUENTIAL OR OTHER DAMAGES OF ANY NATURE WHATSOEVER IN EXCESS OF THE ORIGINAL PURCHASE PRICE OF THIS PRODUCT. ALL WARRANTIES BY MANUFACTURER ARE SET FORTH HEREIN AND NO CLAIM SHALL BE MADE AGAINST MANUFACTURER ON ANY ORAL WARRANTY OR REPRESENTATION.

Some states do not allow the exclusion or limitation of incidental or consequential damages, or limitations of implied warranties, so the limitations or exclusions set forth in this limited warranty may not apply to you. This limited warranty gives you specific legal rights and you may have other rights, which vary from state to state

The limited warranties for 5 (five) years or 3 (three) years are in lieu of all other warranties expressed or implied, at law or otherwise, and DGI does not authorize any person or representative to assume for DGI any obligation or liability in connection with the sale of the wood pellet grill. This means that no warranties, either expressed or implied, are extended to persons who purchase the product from any one other than DGI.

Procedures for Warranty Service

Call your nearest “Louisiana Grills” dealer for repair or replacement of your “in-warranty” parts. Be prepared to furnish the following information:

1. Purchaser's name, model and serial number of grill and date of purchase
2. An accurate description of the problem.

THIS LIMITED WARRANTY GIVES YOU SPECIFIC LEGAL RIGHTS AND YOU MAY HAVE OTHER RIGHTS, WHICH VARY FROM STATE TO STATE

SERIAL NUMBER AND MODEL NUMBER

Your serial number and the model number of your country smoker can be found on the inside of your hopper lid. Be sure to record these in the space provided below to aid you if they get damaged or lost.

Model

Serial Number

Date of Purchase

Authorized Dealer



WIRING DIAGRAM



Country Smoker Board & Wire Harness

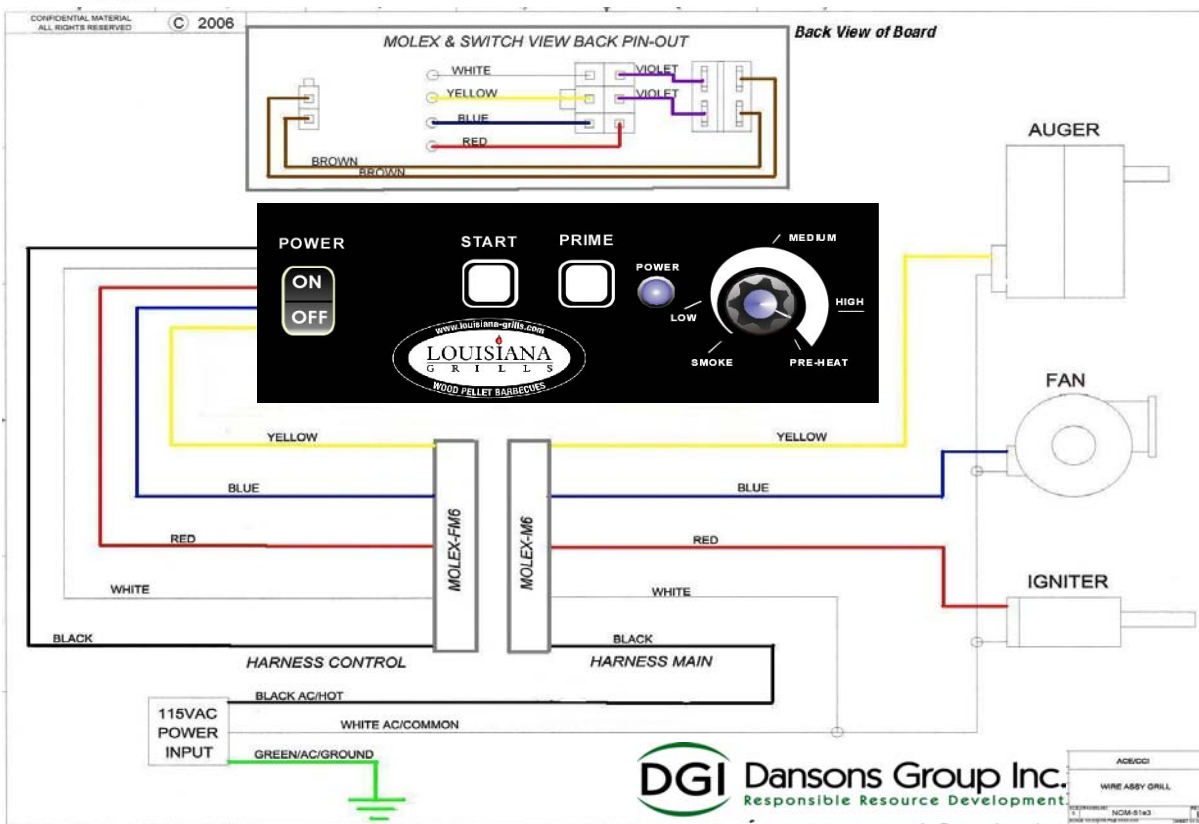

PARTS, SERVICE AND ACCESSORIES

Dansons Group Inc. stands behind our Authorized Dealers. We strongly suggest that if you do need to order any parts or options or require service, that you first deal with your local dealer. Many dealers do stock parts and options. The majority of the parts names can be found on page 5 of this manual on the "How Your Country Smoker Works" page.

If for any reason you do not have a local dealer, Dansons Group Inc. is proud to offer the best technical and sales support in the industry. If you require parts, options, rubs and spices, or general accessories you can contact the factory directly :



"The Innovators."

Louisiana Grills Customer Service

TOLL FREE: 1-877-303-3134

TOLL FREE FAX: 1-877-303-3135

Email: service@dansons.com

Website: www.louisiana-grills.com OR www.countrysmokers.com

CHECK OUR WEBSITE FOR UP TO DATE ACCESSORIES, OPTIONS, AND INFORMATION!!

