

HearthStone III

CATALYTIC

SAFETY NOTICE: IF THIS STOVE IS NOT PROPERLY INSTALLED, A HOUSE FIRE MAY RESULT. FOR YOUR SAFETY, FOLLOW THE INSTALLATION DIRECTIONS. CONTACT LOCAL BUILDING OR FIRE OFFICIALS ABOUT RESTRICTIONS AND INSTALLATION INSPECTION IN YOUR AREA.

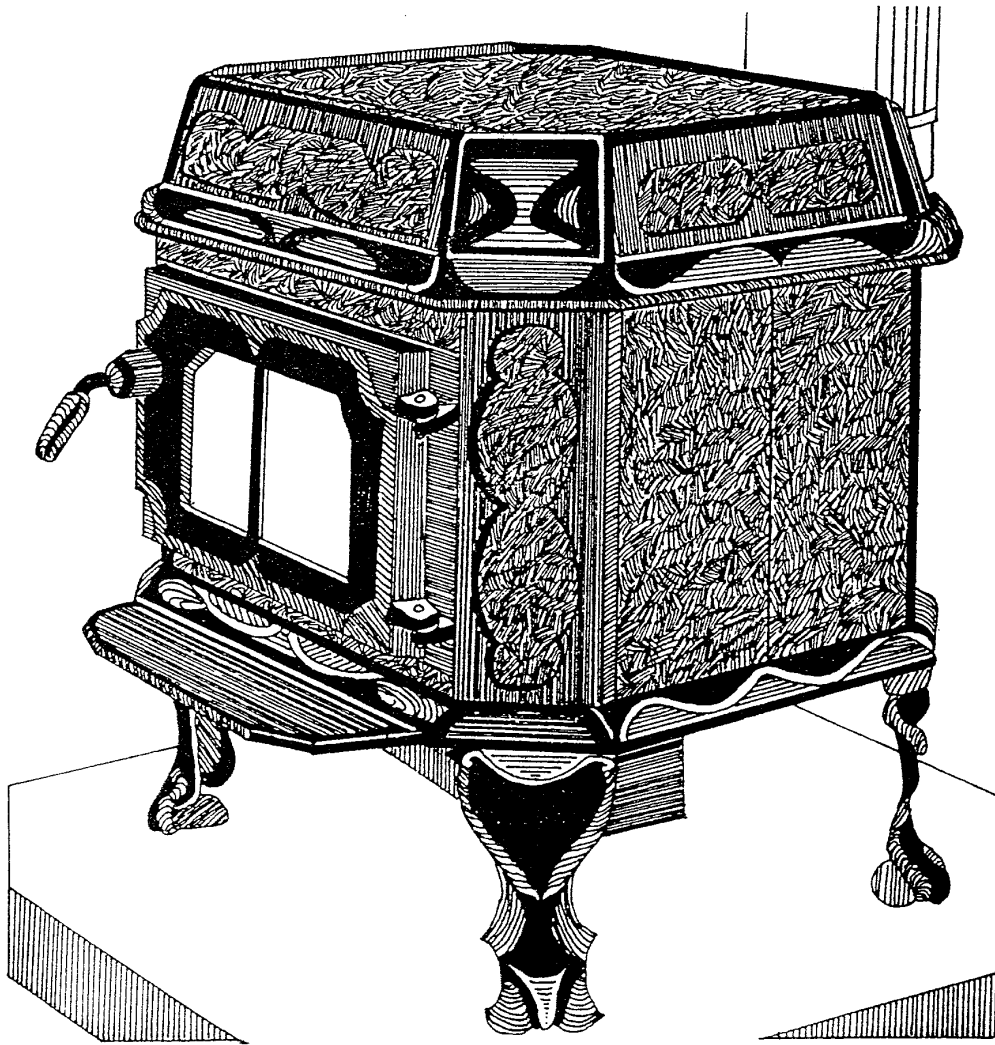

Owner's Manual

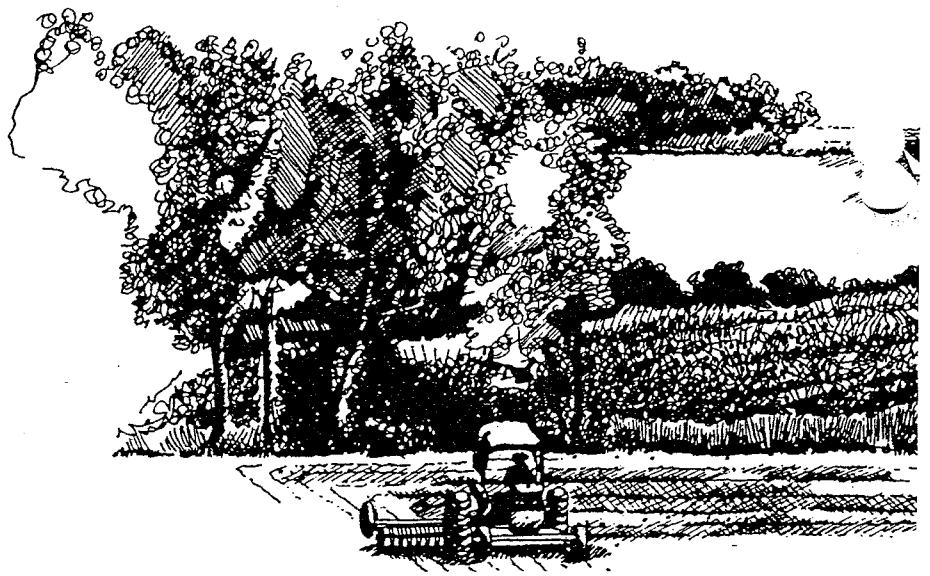

WELCOME to the HearthStone family. You have made an investment in perhaps the finest solid fuel radiant/convection heater available today. To own a HearthStone is to make a statement - a statement of your appreciation and understanding of a quality handcrafted product.

Please read this manual in its entirety. Its purpose is to familiarize you with your stove's safe installation, proper break-in, operation and maintenance. It contains information that will be useful to you now and in years to come, so keep it handy and refer to it as needed.

The performance of your stove depends on many variables that make your installation unique. The sections on operating procedure and general information, therefore, can only serve as useful guidelines rather than hard and fast rules. Should you have any questions, do not hesitate to contact the factory or your dealer for additional information. You have invested in a product whose warranty is accompanied by a pledge to provide you with assistance as long as you own your stove.

TO VALIDATE YOUR WARRANTIES, FILL OUT ALL WARRANTY INFORMATION IMMEDIATELY UPON INSTALLATION OF YOUR STOVE, MAILING APPROPRIATE COPIES TO N.H.C. OR THE COMBUSTOR MANUFACTURER, AS INDICATED. FAILURE TO DO SO COULD CAUSE UNNECESSARY DELAYS IN THE PROCESSING OF WARRANTIED PARTS AND REPAIRS.

IMPORTANT

PLEASE READ CAREFULLY

- DO** Read and understand this Owner's Manual thoroughly before installing or operating the stove.
- DO** Install the stove according to HearthStone's recommended clearances. (See Page #6)
- DO** Install this appliance with the proper sized chimney. (See Pages #2-4)
- DO** Monitor the operating temperatures in the stove-pipe at all times with a probe type thermometer installed 12 to 18 inches from the stove. Temperature should not exceed 600^oF.
- DO** Maintain all door gaskets in good condition, especially the ash pan door gasket.
- DO** Understand that the HearthStone III Catalytic requires a minimum draft of 0.06 inches, water column, to operate effectively.
- DO NOT** Tamper with or modify this appliance in any way. Doing so will compromise your safety, particulate emissions and void your warranty.
- DO NOT** Expect the stove to heat more than 50% of the recommended volume if installed in a basement or in any area with a large portion of uninsulated masonry walls.
- DO NOT** Burn kiln dried, treated wood, plywood or colored paper. Burning these will shorten the life of the combustor.
- DO NOT** Burn the stove with the ash door open or improperly sealed. Overfiring may cause flame impingement on the catalytic combustor will would cause early failure.
- DO NOT** Operate the stove without door gaskets in place.
- DO NOT** Fail to inspect the chimney as recommended.
- DO NOT** Ignore a sudden change in performance of the stove. Refer to the "Troubleshooting" section of the Owner's Manual. (See Pages #17 & 18)
- DO NOT** Connect this unit to a chimney flue serving another appliance.

This wood heater contains a catalytic combustor, which needs periodic inspection and replacement for proper operation. It is against the law to operate this wood heater in a manner inconsistent with operating instructions in this manual, or if the catalytic element is deactivated or removed.

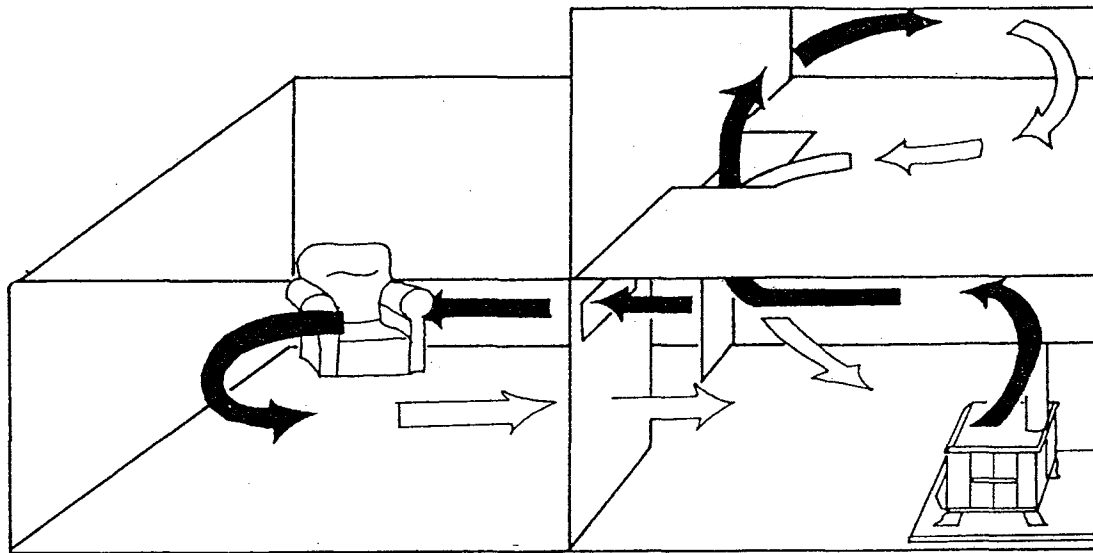

SAFETY NOTICE: IF THIS STOVE IS NOT PROPERLY INSTALLED, A HOUSE FIRE MAY RESULT. FOR YOUR SAFETY, FOLLOW THE INSTALLATION DIRECTIONS. CONTACT LOCAL BUILDING OR FIRE OFFICIALS ABOUT RESTRICTIONS AND INSTALLATION INSPECTION IN YOUR AREA.

PART I: INSTALLATION

SECTION A: LOCATE YOUR STOVE FOR OPTIMUM COMFORT

The useful heat output of your stove is delivered both as radiant and convection heat. Radiant heat directly warms the walls, ceiling, furniture -- the masses surrounding your stove. Convection heat is also provided as a result of the design of the stove. The heated air in the chamber, between the inner firebox and the outer soapstone walls, rises through louvers in the top of the stove. This causes the cooler air from the floor to be pulled through the chamber at the bottom of the stove, thus creating air currents which promote increased distribution of warmth.

Your HearthStone's soapstone walls produce an incredibly even, gentle, radiant heat that travels throughout the area to be heated -- in most cases, no matter where you locate the stove. By locating the stove centrally and providing for the free flow of heated air, you can optimize uniform heating. While not essential, an open floor plan is ideal because neither radiation nor air flow is inhibited by interior walls. Ceiling-level registers and/or fans, can often dramatically help move warm air into adjacent rooms.

Locating your stove in a basement that is not insulated is a great way to heat your basement, but not the rest of your house. The amount of radiant energy required to heat your basement walls is so great that most of the useable heat is absorbed by them and lost. Generally, your HearthStone stove belongs in your living area. The same heat loss principal applies to structures with a lot of uninsulated mass.

SECTION B: CHIMNEYS

Your stove's performance depends on the following:

1. Chimney and installation.
2. Operating technique.
3. Quality of the fuel.

You can vary the operation of your HearthStone, and over the years you'll probably use wood of varying quality, but once your chimney is in place, it's usually there to stay. If you plan to use an existing chimney, then the following information will help you determine if it is suitable for your HearthStone III Catalytic. If you intend to build a new chimney, this information will help you make the right choice.

1. HOW CHIMNEYS WORK

A basic understanding of how a chimney works will help you get the most out of your HearthStone. A chimney's function is to . . .

- . . . vent emissions safely out of your home
and
- . . . supply the draft necessary to pull air into
your stove's firebox - which keeps the fire

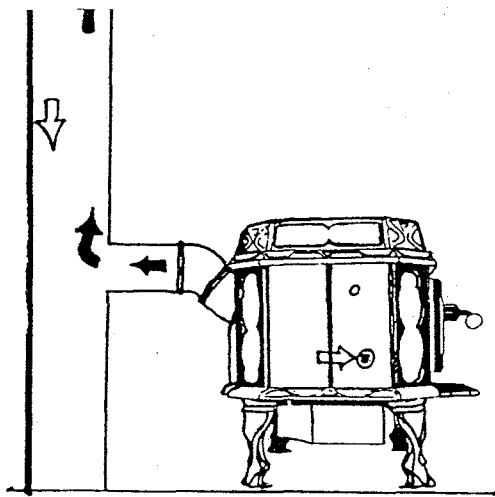

MASONRY CHIMNEYS

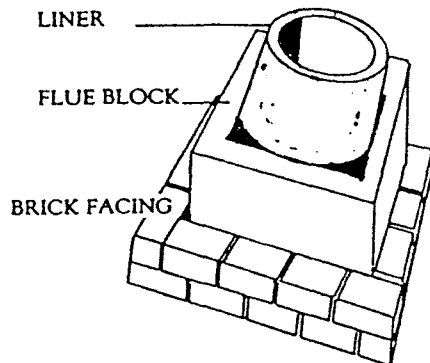

Masonry Chimneys

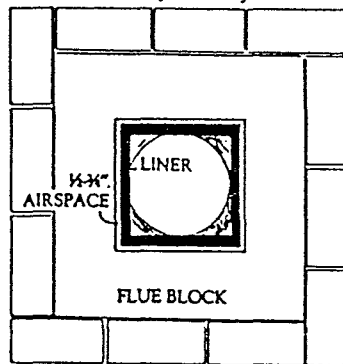

WHAT IS DRAFT?

Buoyancy, or the tendency for hot air to rise, creat draft. As you start a fire in your stove, the hot air ris into your chimney and is vented outside. The chimney gradually becomes hot and aids in maintaining draft. Often, until the stove and the chimney are heated, draft is not adequate for optimum performance. The location, size and height of your chimney all affect the draft. Consider the following:

****Properly sized chimneys** maintain proper draft and flow. (See recommended chimney size below).

****Chimney height affects draft** -- the higher the chimney, the stronger the draft. Your chimney should be at least three feet higher than the point where it passes through the roof, or two feet higher than anything within ten horizontal feet. See Ill. Pg. 5

Many factors affect draft, and possibly the performance of your stove. Some are:

****An "Airtight" House** -- If your home is superinsulated or especially well sealed, an inadequate supply of air entering the stove may cause a weak draft. Use of the Outside Air Kit for the HearthStone III Catalytic can correct this problem.

****Tall Trees or Buildings** -- Chronic or occasional down-drafts are often a result of nearby trees and buildings damping the draft from outside.

****Wind Velocity** -- Generally, the stronger a steady wind, the stronger the draft. However, "gusty" wind conditions may cause downdrafts.

****Outside Temperature** -- The colder the outside temperature, the stronger the draft.

****Barometric Pressure** -- On balmy or wet days, draft is generally sluggish.

****Breaks in the chimney** -- An unsealed cleanout door or leaky stovepipe joints may cause inadequate draft.

The III Catalytic will not perform optimally with a draft less than .06" or greater than .12" water column.

Consistent drafts in excess of .12 inches should be curtailed by use of a stovepipe damper. Inadequate draft will cause the appliance to leak smoke into the room through appliance and chimney connection joints. An uncontrollable burn or a glowing red stove part or chimney connector indicates excessive draft.

2. SELECTION

Make sure your mason or contractor notes these design features:

If you plan to provide a new chimney for your stove, you have two basic choices:

1) a masonry chimney or 2) a prefabricated chimney.

Tests have shown that masonry and metal chimneys of similar size do not vary greatly with respect to draft produced under similar conditions. Your personal taste, house design, and budget will dictate which chimney construction you select. Whenever possible, locate the chimney inside the house, as it will draw better, accumulate less creosote, and last longer.

The advantages of a masonry chimney are:

1. The mass of tile and brick helps to reduce temperature fluctuations in the chimney.
2. The heat-holding characteristics of a masonry chimney can keep a home warm long after the fire is out.
3. It can be custom made to suit your needs and taste.

4. If properly constructed, it can be far more resistant to chimney fire damage than metal chimneys.

Masonry chimneys should be Class A, and lined. Liners are commonly made of vitreous clay or terracotta and are designed to withstand high temperatures and corrosion. They are important. We recommend a standard 6" inside diameter round chimney liner with the HearthStone III Catalytic. This can be poured, stainless steel or terracotta. An 8" square liner would be a less desirable substitute.

****We do not** recommend the use of an unlined chimney.

****We do not** recommend reducing the size of the flue at any point to less than 6" in diameter.

A simple diagram of a properly constructed masonry chimney designed to serve the HearthStone III Catalytic appears above.

Solid
Insulation

AIR INSULATED

AIR VENTILATED

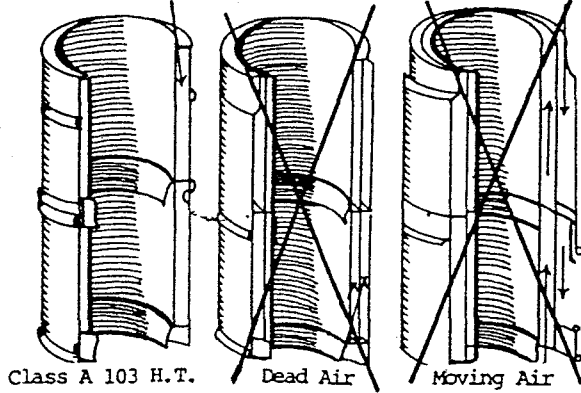

3 PRE-FAB METAL CHIMNEYS FIG. 1

The Advantages of

PRE-FAB METAL CHIMNEYS

The advantages of a prefabricated chimney system are:

1. It is relatively easy to install.
2. You have more flexibility in choosing a location.
3. It can eliminate flow-impeding angles.

Only Class A UL 103 HT, all-fuel, factory built chimneys should be used. You will need a chimney of 6" inside diameter. Three common types of prefabricated metal chimneys are shown above.

Air-ventilated, or thermosiphon type chimneys should not be used because they are not tested to the same criteria - they cause creosote buildup and reduce draft.

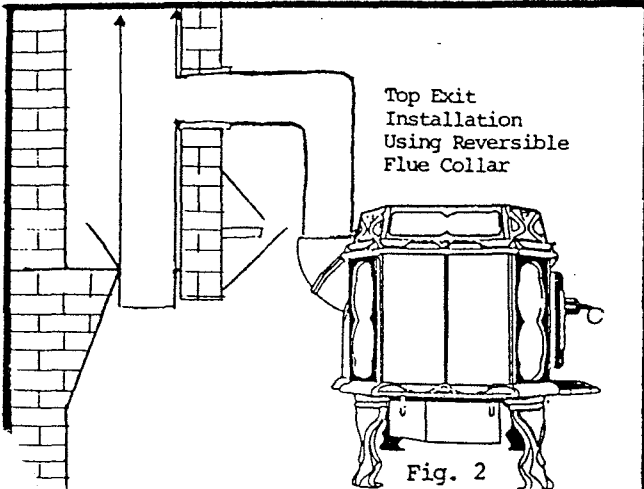

Top Exit
Installation
Using Reversible
Flue Collar

Fig. 2

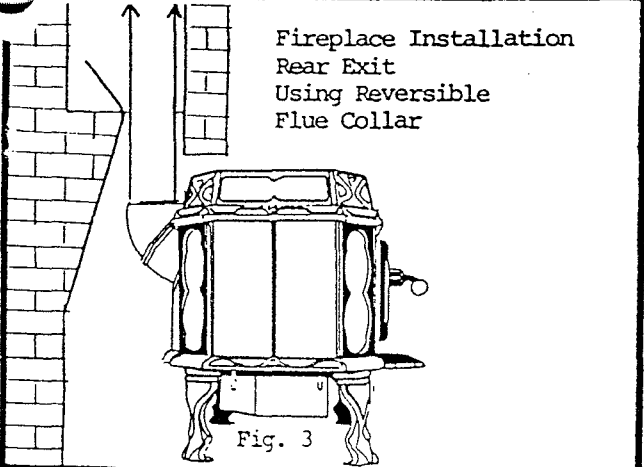

Fireplace Installation
Rear Exit
Using Reversible
Flue Collar

Fig. 3

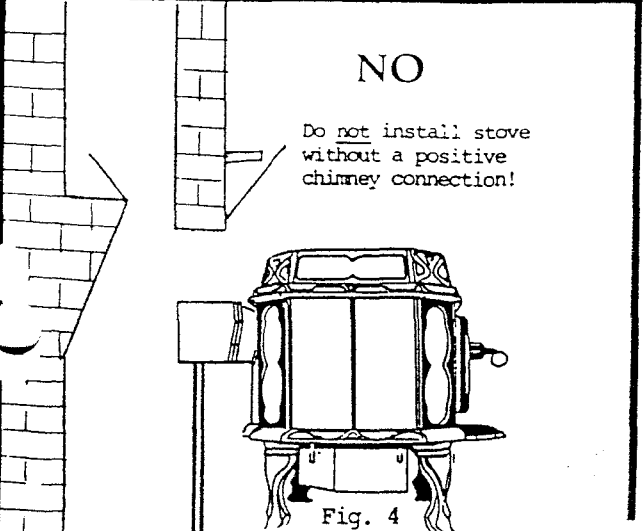

NO

Do not install stove
without a positive
chimney connection!

Fig. 4

SECTION C: FIREPLACE INSTALLATION

Generally, fireplace chimneys are not best for stove installation because all are over-sized and, therefore, promote premature cooling of smoke and gases. Consequently, draft may be reduced and creosote may increase. The best fireplace installation is into an interior fireplace chimney that has been relined to the proper 6" diameter the entire length of the chimney. Figures 2 and 3 illustrate recommended methods of venting your stove into a fireplace chimney. Remember to maintain proper clearances to the fireplace mantel and any other combustible walls or materials.

Figure 2 allows for the easiest routine inspection and cleaning of your chimney, although it requires the installation of a thimble above the fireplace opening.

We do not recommend connecting the stove . . .

. . . only as far as a metal plate sealing the fireplace opening (See Fig. 4), or

. . . only as far as the fireplace damper, or

. . . only as far as the first flue, or

. . . to a factory built, zero clearance fireplace chimney.

We do recommend contacting a professional before attempting a fireplace installation. The chimney needs inspection for repairs or modifications. There are different ways to reline and insulate a chimney. The installation should be approved for safety.

NOTE: Use of Aluminum Type B gas vent for solid fuels is unsafe and prohibited by the National Fire Protection Association Code. 24-gauge stovepipe (or heavier) must be used to connect your stove to the chimney flue. A reversible flue collar is supplied with your stove and is required for proper installation.

SECTION D: STOVEPIPE

1. INSTALLATION

Your HearthStone III Catalytic is designed for use with a 6" stovepipe. The crimped ends of the stovepipe should point down (toward the stove) and fit inside the reversible flue collar, thus eliminating creosote leakage. Each stovepipe joint should be secured with three sheet metal screws. Holes are pre-drilled in the HearthStone flue collar to accept 1/8" X 1/2" sheet metal screws.

The longer the stovepipe length and/or the larger the number of elbows, the greater the chance of dangerous creosote and ash build-up. In the past, installers strove for long runs to ensure maximum heat dispersal. Consequently, stovepipe length should ideally be kept to 4' or 6' and any horizontal runs of pipe should rise a minimum of 1/4" per foot and should be kept to a minimum to prevent creosote and ash build-up.

Particular attention should be paid to the point where the stovepipe passes through a wall or ceiling. This penetration should always be made with a UL approved wall pass-through system or be approved by your local building inspector. Once made, the remainder of the chimney should be insulated pipe only. The stovepipe should extend into the chimney thimble at least 2", but should not extend into the flue.

The illustration following, - shows standard stovepipe assembly for a woodburning installation. Drawbands and slip-joints greatly simplify the connection of stove to chimney. Additionally, they allow for easy inspection and dismantling of the stove without moving the stove.

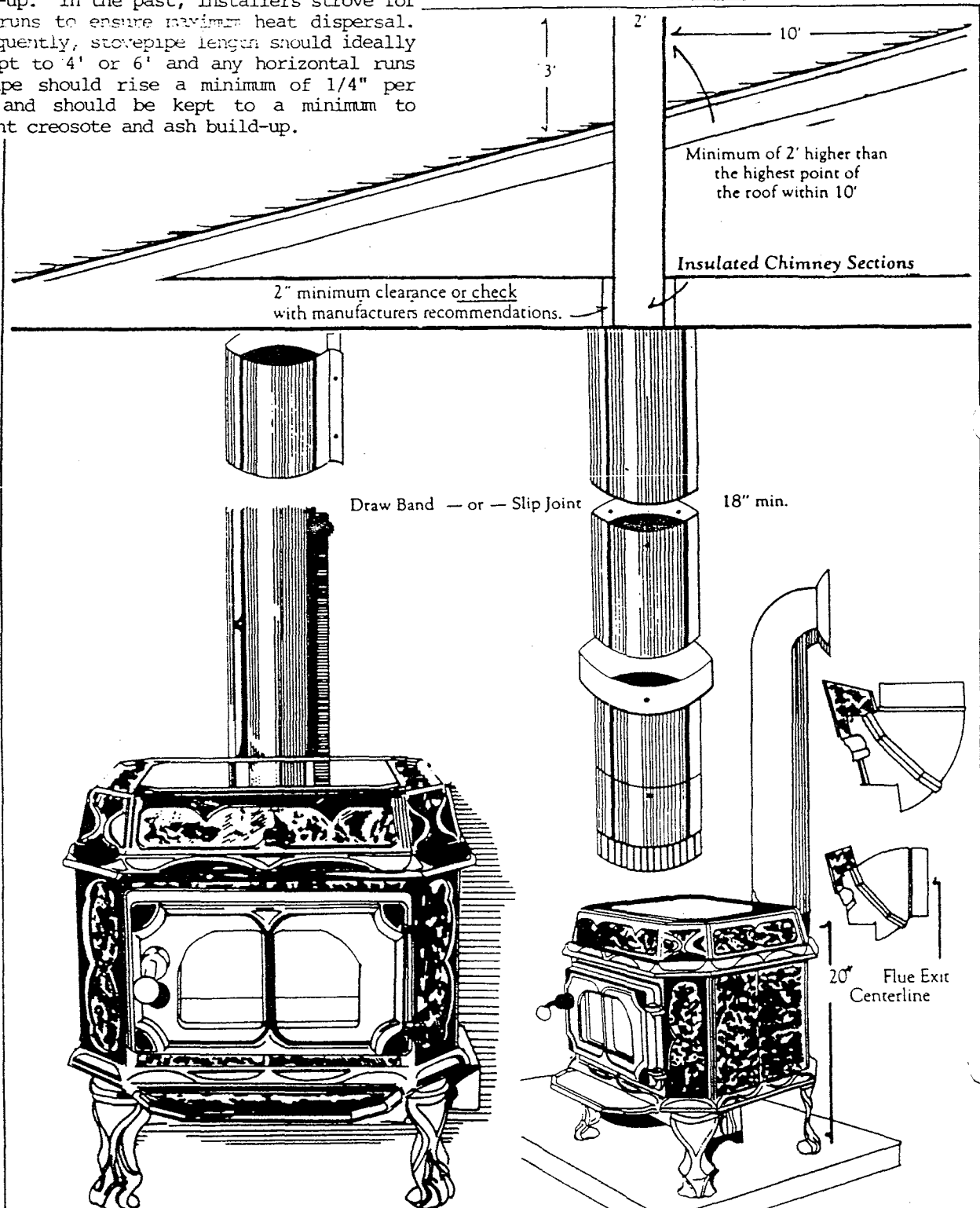

PART II. OPTIONS

The following options are available for use with your HearthStone III Catalytic woodstove. Contact your local Authorized HearthStone Dealer for details.

<u>ITEM #</u>	<u>ITEM</u>
57305	HIII Catalytic Standard Rear Heatshield Kit
57306	HIII Catalytic Deluxe Rear Heatshield Kit
57323	HIII Catalytic Outside Air Kit
57322	HIII Catalytic Standard Reduced Clearance Kit (Standard Rear Heatshield with 3 - 2 ft. Pipe Shields)
57332	HIII Catalytic Mobile Home Kit -- Required for Mobile Home Installations (Items 57306 & 57323)

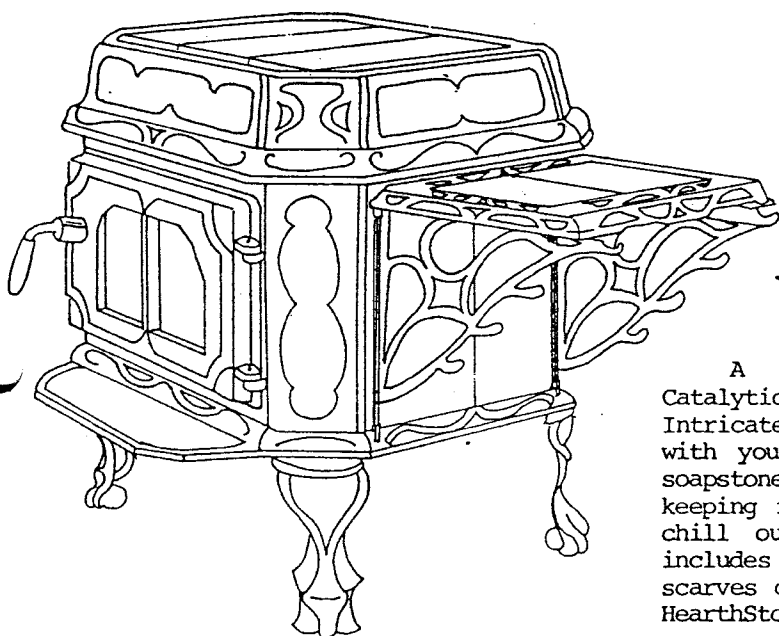

Warming Shelf

A special option for your HearthStone III Catalytic woodstove is an attractive warming shelf. Intricately styled in finely sculpted cast iron, inset with your choice of two natural, polished or brown soapstone pieces, the warming shelf is perfect for keeping food warm, letting bread rise, or taking the chill out of cold winter boots. The shelf design includes a bracket with two hooks for drying mittens, scarves or hats. It's the perfect compliment to every HearthStone woodstove.

Ask your Authorized HearthStone Dealer about a warming shelf for your HearthStone III Catalytic woodstove.

PART III. ASSEMBLY

Your HearthStone III Catalytic is completely assembled. Once situated on your hearth, all that remains to be accomplished is...

...ATTACH THE REVERSIBLE FLUE COLLAR: Packaged with the stove is a flue collar, hardware, and 1/4" rope gasket to attach the flue collar. For top vent installations, make sure the exit hole is facing up. For rear vent installations, the exit hole should be facing away from the stove. Place the flue collar on the stove in the desired exit mode. Start the bolts that hold the flue collar to the stove, but do not tighten them. While the flue collar is still loose, pack the 1/4" rope gasket in between the collar and the stove. Snug the bolts.

...INSTALL THE BOTTOM HEAT SHIELD: This is to be used with the HearthStone III Catalytic, along with a composition hearth as specified in Section E-1. You will find four metal legs, packed in a plastic envelope inside the stove. Slide one leg onto each of the four slots in the shield. The completed shield rests freely underneath the stove. The stove will have to be lifted on one end in order to slide the shield under the stove.

2. STOVEPIPE CLEARANCES

Stovepipe must be a minimum of 18" from any combustible surface or material. If shielded stovepipe is used, this clearance may be reduced to 9". However, keep in mind the recommended clearances for your stove which may determine the overall clearances.

SECTION E: HEARTHES

1. HEARTH COMPOSITION

Local fire safety requirements may vary, but we require a minimum of 4" of masonry (standard brick standing on edge) mortared onto 28-gauge sheet metal which covers a plywood sub-hearth. An acceptable alternative to this composition requires use of the HearthStone Heat Shield, 3/8" millboard (or equivalent) covered with a non-combustible material of any thickness (tile, slate, etc.).

The hearth should extend beyond the body of the stove by the following dimensions:

Front	16"
Sides	8"
Rear	8"

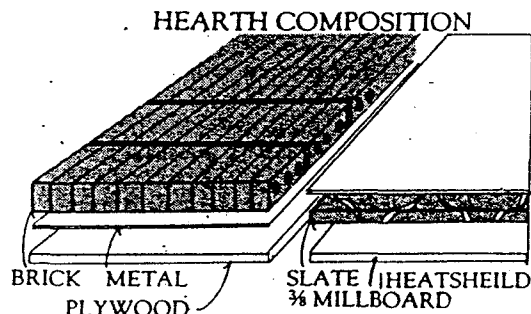

2. HEARTH SIZE

Therefore, the recommended minimum dimensions are 40" wide x 45" deep.

NOTE: Dimensions of the body do not include the ash lip.

SECTION F: STOVE CLEARANCES

1. COMBUSTIBLE SURFACES

A combustible surface is one that has any combustible components, regardless of its covering. For example, a standard stud wall covered with sheetrock and further covered with brick conducts heat very rapidly to the sheetrock and studs.

Without adequate clearances or a HearthStone Heat Shield, the wall materials will dry out over time and their ignition temperatures will be drastically reduced, thereby increasing the chances of spontaneous combustion.

The following clearances to combustible surfaces are approved in accordance with UL standards 737 and 1482.

NOTE: In some instances, local building codes may supercede HearthStone's requirements. On any unshielded installation, HearthStone recommends a 36" clearance to all combustibles.

HIII Catalytic Clearances To Combustibles

TOP OR REAR EXIT,
UNSHIELDED

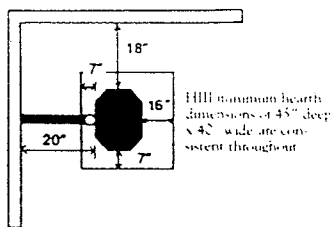

TOP EXIT ONLY
WITH DELUXE HEAT SHIELD
AND CLASS A 103 HT PIPE

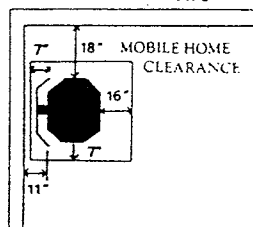

TOP OR REAR EXIT WITH
STANDARD HEAT SHIELD
AND PIPE SHIELD OR DOUBLE
WALL PIPE

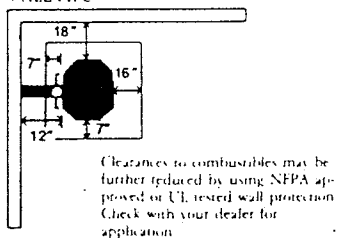

TOP OR REAR EXIT,
UNSHIELDED

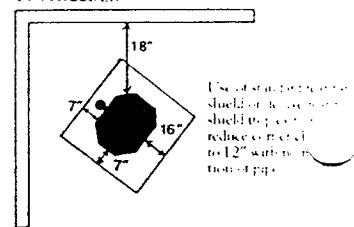

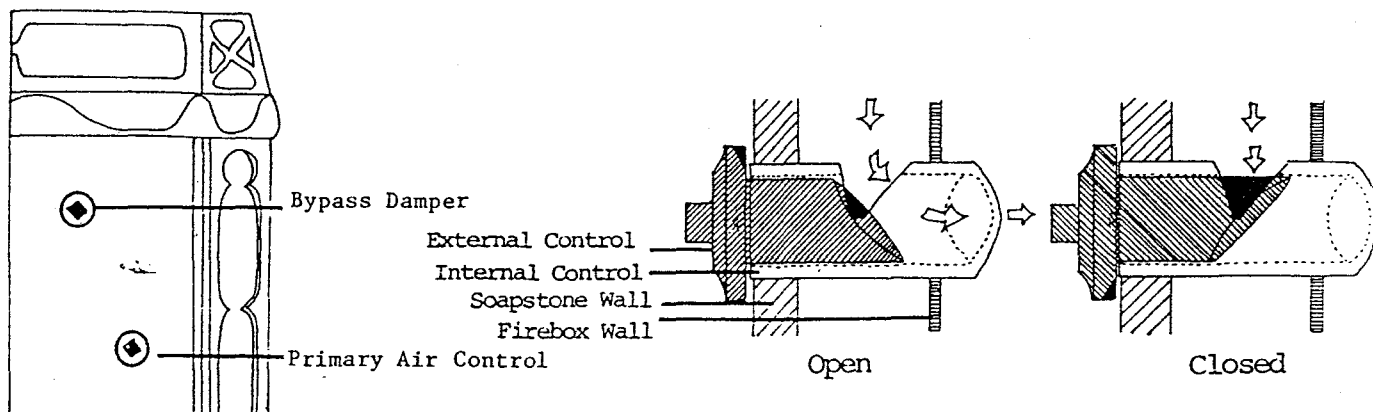

Fig. 5

Primary Air Controls

PART IV: OPERATION

SECTION A: THE CONTROLS OF YOUR HEARTHSTONE

The HearthStone III Catalytic has been designed for ease of operation. (Please refer to Figure #5 above and Figure #9 on Page 14.

PRIMARY AIR CONTROL - A spin draft for primary combustion air is located on the left of your stove. The entire adjustment range is 180° in arc, clockwise to open - counter-clockwise to close. There are two wedge shaped indentations of the spin draft. When this knob is turned fully clockwise (to the full open position), the larger indentation will be facing upward. When turned fully counter-clockwise (in the full closed position), the larger indentation will be facing downward. Your heating needs will determine what intermediate setting will be the most advantageous to meet these needs.

BYPASS DAMPER - Also located on the left of your stove. Counter-clockwise to vertical is open, clockwise to horizontal is closed. The normal operating position for the damper is in the closed (horizontal) position.

WOOD GRATE - The wood is burned directly on the slotted wood grate. Be certain the seven (7) vertical slots are in the rear so that the combustion byproducts can easily be vented through the combustor.

SECTION B: BREAKING IN YOUR STOVE

1. THE REASONS FOR BREAK-IN

It is imperative that your stove be broken in very slowly. There are several reasons why:

1. Cast iron must be "seasoned." Overfiring a new stove may cause the bottom casting to crack and damage other stove parts.
2. Moisture in the soapstone must be driven out slowly to minimize the "shock" to the stone of its first exposure to high firebox temperatures.
3. The asbestos-free furnace cement must be cured slowly to ensure adequate sealing and bond.

It is **recommended** that the stove have at least **one break-in fire** after sitting idle for a long period of time or over the summer.

WARNING

This heater is designed to burn natural wood only. Higher efficiencies and lower emissions generally result when burning air dried, seasoned hardwoods, as compared to softwoods or to green or freshly cut hardwoods.

DO NOT BURN:

* Treated Wood	* Coal
* Garbage	* Cardboard
* Solvents	* Kiln Dried Wood
* Colored Paper	* Trash

Burning treated wood, garbage, solvents, colored paper or trash may result in release of toxic fumes which may poison or render ineffective the catalytic combustor. Burning coal, cardboard or loose paper can produce soot or large flakes of char or fly ash that can coat the combustor, cause smoke spillage into the room, and thus render the combustor ineffective.

2. THE FIRST FIRES

Before building your first fire, the bottom casting of your stove must be protected. Sprinkle a layer of common sand or ash in the gap between the wood grate and firebox wall - not in the ash pan - (approximately 1/2" in depth). Build the fire directly on the sand or ash covered wood grate.

To build your first fire, place five or six double sheets of tightly twisted newspaper on the grate. Arrange kindling in a criss-cross pattern over the newspaper -- approximately 10 pieces, 1/2" in diameter, and 10" to 14" long. Check to make sure the bypass damper is in the open position and that the primary air control is fully opened. Light the paper under the kindling and close the door. When the kindling fire is well lighted, close the primary air control halfway. When the fire is fully established, close the primary air control to 1/4 open.

Under a watchful eye, maintain a steady, low-heat fire. We recommend the stove-top temperature be very warm, not hot to the touch, (150°) for your first and subsequent break-in fires. Once these temperatures are achieved, close the primary air control completely. Allow the fire to die out completely and the stove to return to room temperature.

We recommend that your first three fires be built and maintained accordingly. Your patience will be rewarded by a properly seasoned HearthStone stove.

During break-in and for your initial fires, you may notice an unpleasant odor. This is normal, as it emanates from stovepipe paint, interior stove paint and gaskets which are undergoing a curing process. Weather permitting, a window can be opened during break-in fires to help disipate some of the odor. The odor will disappear after minimal use.

Also during break-in, because of the low exit flue temperatures, a number of atmospheric and installation factors occasionally contribute to condensation forming on the stovepipe. This condensate may run down the inside of the stovepipe and leak from the flue collar connection. Placing a metal bucket under the flue collar connection during break-in fires will prevent staining of expensive tile on the hearth. This problem will cease after normal use begins.

SECTION C: NORMAL OPERATING PROCEDURE

1. Open bypass damper.
2. Place kindling in firebox. (If reloading, refer to Step 8.)
3. Open primary air control completely.
4. Light fire.

NOTE: Due to the fact that the chimney is cold at the start of the fire, some smoke spillage may occur at first. With the door open, smoke spillage may also occur in low draft situations, due to warm weather, windy conditions, high barometric pressure and weather fronts.

5. When kindling catches fire, leave front door open approximately 1" until fire is established and some coals develop.

6. Add logs and leave front door slightly

7. Close the front door.

The temperatures in the stove and the gases entering the combustor must be raised to between 500° to 700°F for catalytic activity to be initiated. During the start-up of a cold stove, a medium to high firing mode must be maintained for about 20 minutes. This ensures that the stove, catalyst and fuel have all stabilized at proper operating temperatures.

Even though it is possible to have gas temperatures reach 600°F within two to three minutes after a fire is started, if the fire is allowed to die down immediately, it may go out or the combustor may stop working. Once the combustor starts working, heat generated in it by burning the smoke will keep it working. When the combustor has achieved light-off, adjust the air control as desired.

8. When reloading, open the bypass damper and wait approximately thirty (30) seconds before opening the front door. Add logs. Close the door and the bypass damper. During the refueling and rekindling of a cool fire, or a fire that has burned down to the charcoal phase, operate the stove at a medium to high firing rate for about 10 minutes to ensure that the catalyst reaches approximately 600°F.

9. Adjust the primary air control as desired.

NOTE: In spring and fall when atmospheric conditions don't allow for a strong draft, we recommend that you:

- start with small kindling to heat the chimney quicker and establish the draft.
- use small hardwood as opposed to logs to keep the fire brisk.
- tend the fire frequently

NORMAL OPERATING TEMPERATURES

When the stove is operated with the damper closed and the combustor engaged, normal temperature ranges will be as follows:

** Combustor - 800° to 1500°F

** Stovepipe (12" from flue collar) - 420° to 600°F*

** Top stones -- 300° to 550°F

** Side stones -- 250° to 375°F

Keep in mind two points about the combustor temperature:

1. A slower burn may produce a higher combustor temperature.
2. Toward the end of the burn, the combustor temperature will drop off when the fire enters the "charcoal phase" as there will be less smoke (fuel) for the combustor to burn.

The best place to monitor the stove performance is at the combustor. A probe is provided with the stove. We suggest purchasing a monitor to read temperatures at the combustor. This will help insure that you are getting the full benefit of your HearthStone III Catalytic Stove

SECTION D: EVERYDAY USE

1. GENERAL GUIDELINES

Once properly broken in, your HearthStone III Catalytic is ready for continuous operation. The heat demands of your living area will determine how frequently you will have to load your stove. Generally, you will find it necessary to add wood four to six times every 24 hours.

If your stove is not to be used continuously, we recommend a relatively small fire when starting a cold stove. Let all the stove surfaces become uniformly warm before loading for a hot fire.

The following is a list of guidelines for in-season, every day use:

** Burn well seasoned, air-dried wood, preferably hardwood because of the higher BTU content per piece. (Well seasoned firewood is that which has been cut, stacked and covered for a minimum of one year and has a 16% to 20% moisture content.)

The firebox is designed to accept a maximum log length of 14". However, to maximize the size of the fuel load, the log length should vary from 12" to 14".

** Reload on a bed of red, hot coals. This practice reduces smoking time and will bring fresh fuel up to high temperature rapidly.

** Avoid "one stick" fires. A good fire requires several logs in close proximity to maintain adequate temperatures for efficient combustion.

** Remove ashes as frequently as necessary. Excessive ash build-up will reduce the heat output of your stove. Easy ash removal is accomplished by using the ash pan supplied with the stove.

** If operation becomes sluggish, scrape fly-ash from the perforated screen (rear of the firebox).

NOTE: The proper tool makes all the difference for "tending" of ashes. We recommend a small fireplace hoe. When it is raked across the wood grate of the HearthStone III Catalytic, fine ash is encouraged to fall through the slots in the grate into the ash pan.

Overfiring means running your stove at excessively high temperatures for extended periods of time. Because it can cause damage to the stove, it should be carefully avoided.

To avoid damage to the castings, the stove or the catalytic combustor, never operate the stove with the ash pan door open. It is dangerous to have the ash pan door ajar especially if the bypass damper is closed. As a further precaution, we recommend monitoring the stovepipe temperatures with a probe type thermometer 12 to 18" from the stove. This is the best way to monitor firebox activity.

Examples of the damage caused by overfiring are: blistering or bubbling of porcelainized surfaces, damage or warping of the internal firebox components.

EVIDENCE OF ANY OF THESE SYMPTOMS OF OVERFIRING WILL VOID YOUR WARRANTY.

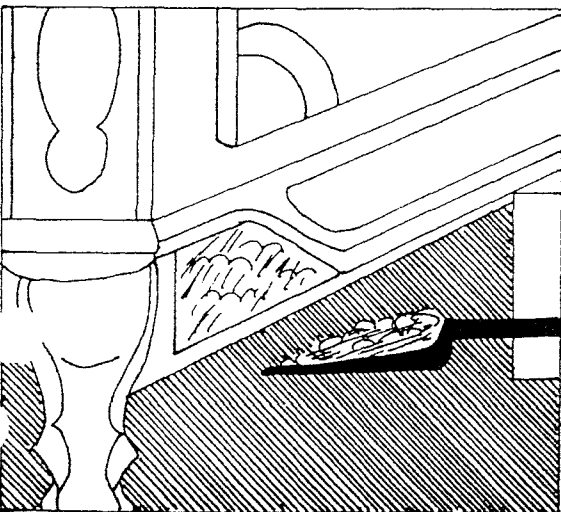
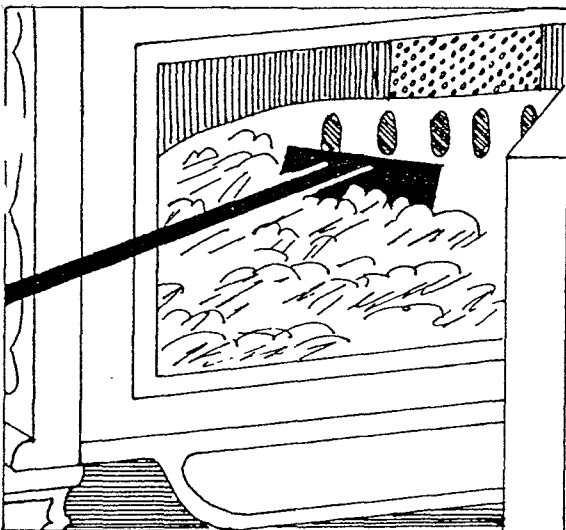
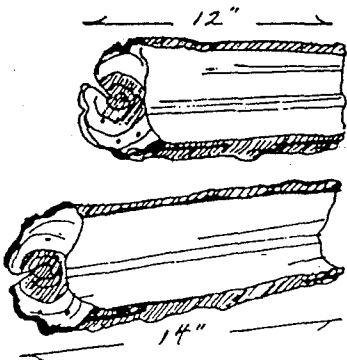

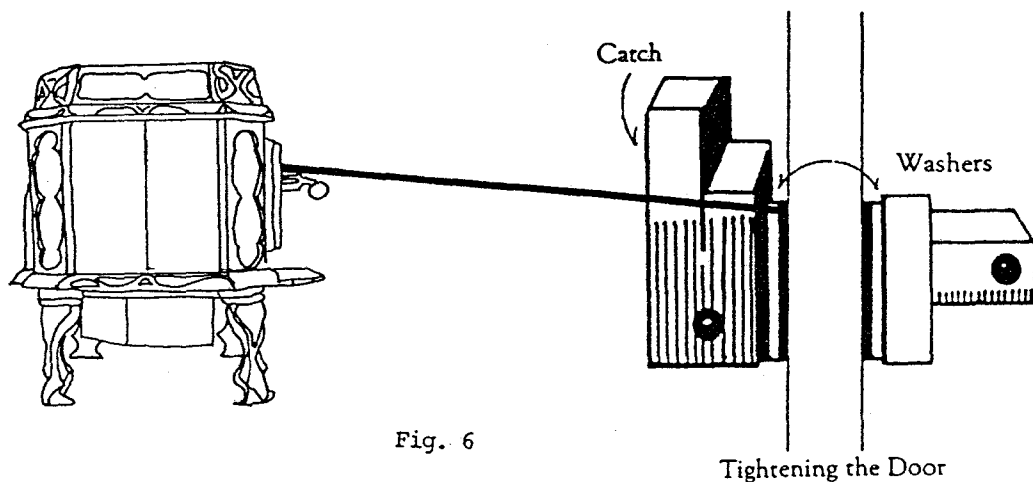

Fig. 6

Tightening the Door

PART V: MAINTENANCE

SECTION A: DURING THE HEATING SEASON

Your HearthStone III Catalytic is an appliance that is subjected to temperature extremes and the corrosive residues of burning wood for long periods of time. Periodic maintenance is essential to keep your stove performing as it should. All parts and special maintenance kits are available through HearthStone or your local Authorized HearthStone Dealer.

Every Day:

Check ash accumulation and remove ashes, if necessary. Care should be taken not to push ashes into the mixing chamber behind the firebox. Ashes should be placed in a metal container with a tight fitting lid. The closed container of ashes should be removed from the house immediately. If the ashes are to be disposed of by burial in the soil, or otherwise locally dispersed, they should be retained in the closed container until all cinders have cooled.

Every Two Weeks:

1. Visually inspect stovepipe and chimney for creosote accumulation.
2. Inspect the door glass.
3. Scrape fly ash from the perforated screen in rear of firebox.

If the draft is low it may require the glass to be cleaned as often as every fourteen (14) days. This varies depending on draft conditions.

Every Eight Weeks:

Check door frame seals by holding a smoldering stick or cigarette on a stick around the edge of the door while the stove is operating at the highest setting. If you observe smoke being drawn into the stove, tighten the fit of the door by removing a washer from the inside of the handle and replacing it on the outside of the handle. To do this, tap the pin out of the handle assembly with a 3/16" pin punch or a blunt nail. Remove the handle and washers and then pull out the catch. Move one of the washers from the catch side to the handle side. Replace the catch, washers and handle and tap in the pin with a hammer. (See Fig. 6). If this does not sufficiently tighten the door seal, then replace the door gasket.

At Least Three (3) Times During the Heating Season:

Remove the splined top stones from a cold stove and visually inspect the catalytic combustor. This may be done without physically removing the combustor from the stove. Verify that the combustor is there or that large holes through it do not exist. While there, remove any ash build-up. See Section entitled Combustor Maintenance for more information.

SECTION B: AT SEASON'S END

Every Twelve Months:

1. Dismantle stovepipe and clean thoroughly. Replace any pieces that show signs of rust or deterioration.
2. Inspect and clean your chimney, if necessary.
3. Thoroughly vacuum out the inside of your stove. Inspect the interior for any signs of damage or deterioration.

NOTE: A collection of soot and creosote on the walls of your stove will dramatically reduce heat output.

4. Repaint castings, if necessary.
5. Follow instructions for inspection.

SECTION C: STONE FINISH

With use, subtle earth tones of brown, red and yellow appear in the soapstone. This is a natural reaction of the soapstone to heat and cannot be controlled. If your stove is a Brownstone, you may, under very close inspection, find an occasional fine surface crack in the stone. Such a hairline crack is just on the stone surface, and does not affect the integrity of the stone in any way.

Occasional cleaning and/or polishing is all that should be necessary to keep your HearthStone beautiful. Care must be taken, however, to prevent scratching, chipping, or staining the stone. Protect the top stone by using a soapstone or tile trivet when placing anything on top. Brief instructions follow for general care of the soapstone:

**** Natural Grey Unpolished Soapstone:** Any surface scratches or discoloration can be removed by lightly sanding with fine sandpaper (200-220 grit). Stains may need a sprinkle of cornstarch before sanding. Wipe the stone with a clean cloth after sanding to remove any dust. Never use water or a liquid cleaner on unpolished soapstone.

**** Polished Soapstone and Brownstone:** As with fine furniture, you may wish to polish the stone periodically to renew the original luster and depth of color. We recommend Krylon silicon spray. Apply it to the stove when the fire is out, and the stone is just warm to the touch, or cooler. Spray the stone, let dry and wipe to remove excess and bring up the polish. How long fresh polish lasts will depend on stove use and/or atmospheric conditions.

SECTION D: CASTINGS

All of the HearthStone III Catalytic's cast iron pieces are treated with a special high temperature paint. A damp sponge will do a fine job of cleaning them. Small cans of the paint are available for touch-up at the end of the heating season. Contact the HearthStone Service Department to order touch-up paint. The porcelainized enamel

III CATALYTIC FRONT DOOR
GASKET/GLASS/CLIPSET PLACEMENT

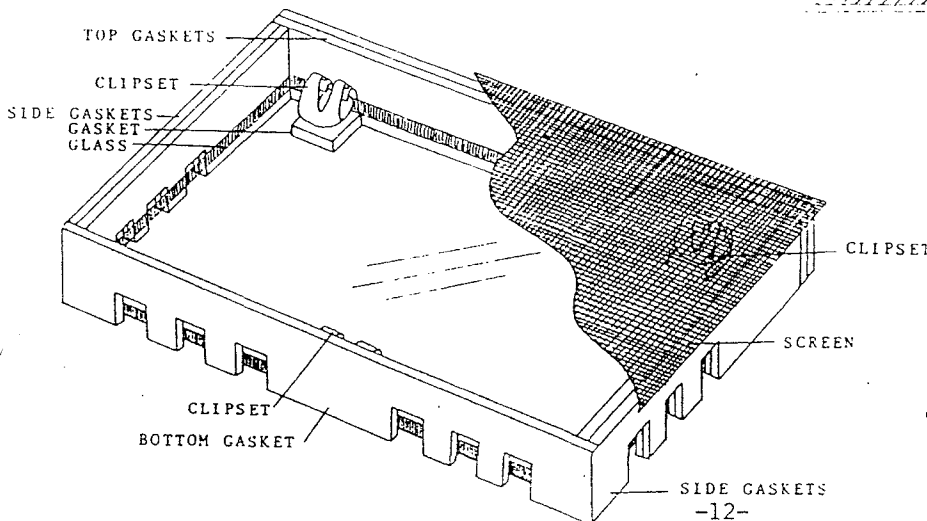

castings of the brownstone model can be cleaned with a standard glass cleaner. With time and use, a very fine subtle network of craze lines will appear seemingly beneath the surface of the enamelled surface. Crizzling is a natural, predictable process and does not represent a flaw in the enamel.

SECTION E: GLASS

The HearthStone III Catalytic front door is designed with an air wash to keep the glass clean and to view the fire. The glass may require cleaning as often as every 14 days depending on the downdraft or low draft situations.

Glass replacement may also be necessary. To obtain access to the glass, observe the following steps and refer to Figures #7 and #8.

1. Take the door off the stove by opening the door and lifting straight up.
2. Lay the door face down on a soft surface.
3. With a 5/16" wrench, remove the 4 bolts holding the interior glass retention frame.
4. Lift the frame and screen away from the door.
5. If the glass just needs to be cleaned, leave it in place and clean with a common household cleaner, wiping with a soft cloth. Go to step #9.
6. If the glass needs to be replaced, remove hooked clips, glass and rigid Garlock gaskets.
7. Place new gaskets in place with the two short pieces on the sides, slots down. The longer slotted piece goes with the bottom, slots down. The unslotted piece goes along the top.
8. Lay the new glass in place with the hooked clips facing you.
9. Reposition the screen and glass frame. Reattach with the screws.
10. Replace the door on the front door frame.

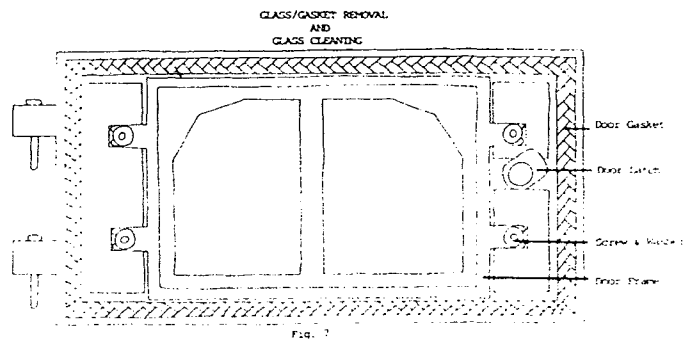

CLIPSET SIDE VIEW

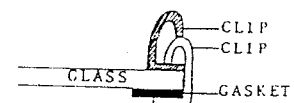

SECTION F: COMBUSTOR

MAINTENANCE OF CATALYTIC COMBUSTOR

The Catalytic Cell has been designed to provide uniform temperature throughout the catalytic combustor, thereby minimizing the likelihood of cracking. It is important to point out that if cracks are observed in the ceramic, it does not mean that there is a problem. Since the ceramic acts only as a mechanical support for the catalyst (a chemical coating on the surface of the ceramic which stimulates combustion without being consumed itself), it may have cracks while being perfectly operational. The performance of the stove, creosote production and Catalytic Monitor temperatures are better indicators of proper or faulty operation.

Cracked catalytic units do not indicate replacement. Combustors do not have to be removed for inspection.

NOTE: The combustor can be damaged by excessive handling. It should not be removed unless it is necessary. Damage done through handling will not be covered by the warranty.

INSPECTION OF THE CATALYTIC COMBUSTOR

1. The catalytic combustor should be visually inspected at least three times during the heating season to determine if physical degradation has occurred. Actual removal of the combustor is not recommended unless more detailed inspection is warranted because of decreased performance. The combustor is accessed by removing the three top stones. The top stones are cemented together. To remove them, reach up through the front door and open damper and push the stones up from underneath.

2. Visually inspect the combustor. Points to check are:

- Structural integrity of the substrate (honeycomb).
- Presence of creosote on or in the combustor.
- Presence of fly ash near the combustor.

Using a soft brush, remove any fly ash resting on the castings and damper area as well as on the combustor.

3. Replacement is only indicated if

- The ceramic honeycomb combustor has physically eroded away, or significant portions of it are missing, or
- The chemical catalyst on the ceramic body has been poisoned.

The latter may be detected by consistently low (less than 500°F) catalytic combustor temperatures.

The former, although unlikely, is obvious from visual inspection.

NOTE: The presence of hairline cracks in the body of the catalytic combustor do not indicate the need for replacement. The chemical catalyst, deposited on the surface of the ceramic, is just as potent on the surface of a cracked ceramic body, as on one which is not cracked. The chemical catalyst is really the working agent of the catalytic combustor. The ceramic body simply provides a surface for the catalyst to lie on. As long as the catalytic combustor is physically there, cracked or not, it is doing its job of providing a clean, energy efficient wood fire.

Consult the combustor's Warranty Card, which is included with your owner's package, and the HearthStone Service Department to obtain a replacement.

4. "Presence of fly ash near the combustor" may vary depending on the strength of the draft. The ash should be removed from the combustor and damper area with the small brush attachment to your vacuum cleaner. Repeated absence of fly ash and continued good combustor operation, as indicated by consistent temperatures on the Catalytic Monitor, would allow for a longer interval between inspections.

Replacement

Combustor Removal & Replacement

- After removing the top stones, as described previously, it will be necessary to remove the combustor cover plate. (See Figure #9)
- Locate the two threaded studs with nuts that hold the cover plate in place. Using two 7/16" socket or open end wrenches, remove the two nuts holding down the combustor and the soft Interam gasket surrounding it.
- Insert the replacement with the gasket in place. Reinstall the combustor and cover plate.
- Reinstall the top stones.

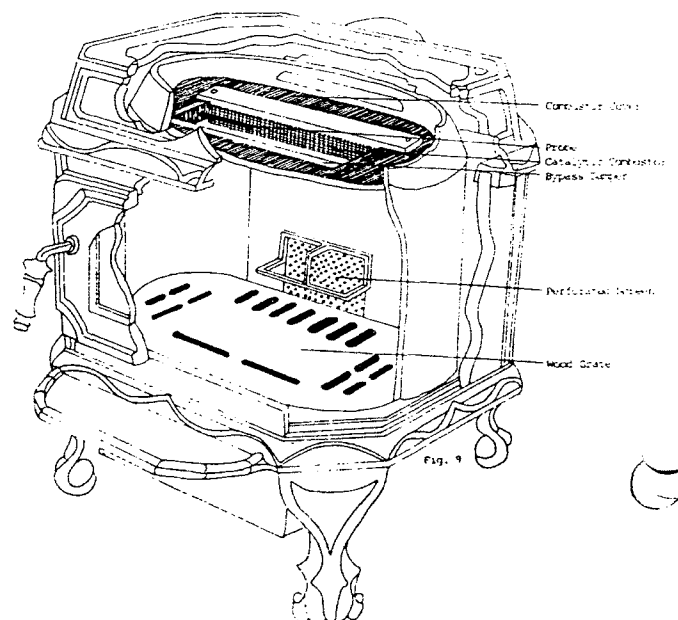

SECTION G: PROBE

Catalytic Probe Replacement

In the unlikely event that the probe to measure the combustor temperature becomes inoperative, it must be replaced. (See Figure #10)

The replacement probe (Item No.56903) is 9" long. It comes without the plastic plug in place. The two metal connectors are attached to the thermocouple wires. Remove the old probe by pulling the probe out of the damper area to the right. (For ease of removal, cut the thermocouple wire near the stainless steel tube). Pull the wire out from the other way. Take the ends of the thermocouple wire and thread them through Hole A and then through Hole B, accessing the latter from inside the firebox. After passing through Hole B, the ends will be visible through the filligree in the top casting. Use a pencil eraser to carefully direct the end of the wire downward as it is pushed through the holes.

DO NOT PULL THE WIRE THROUGH AS THIS WILL SCRAPE THE INSULATION OFF THE WIRE AND POSSIBLY CAUSE A SHORT.

When the probe reaches the holes, push it all the way through Hole A and just into Hole B. The ends of the wire should now be accessible from underneath the stove. Lead them out from between the back legs of the stove. Take the white plastic plug and insert the steel connectors into the end without the lip until they lock in place.

SECTION H: GASKETING

Every Two Years.

Monitoring the gaskets in the HearthStone III Catalytic is crucial to proper operation. The gaskets should be renewed every two years. Replacement gaskets are:

- 1) Front Door Gasket (1/4" Door Rope)
- 2) Ash Door Gasket (1/4" Door Rope)
- 3) Mixing Chamber/Damper Gasket (1/4" Door Rope)
- 4) Top Stones (3/8" Rope Gasket)

These items may be found individually, but for convenience, contact your HearthStone Dealer to obtain the HearthStone III Catalytic Gasket Kit, which has all you need to do the job.

The gaskets are put in place without stretching and are secured by use of gasket cement. After removing the old gaskets, clean the metal surfaces with a wire brush. Apply the adhesive and let it set for 3 minutes before applying the gasketing material.

SECTION I: CEMENT

Resealing -- The only portion of the HearthStone III Catalytic that would require periodic resealing would be where the primary air pipe enters the firebox. A close inspection of the seal, after wire brushing, would reveal any cement failure.

Inspection can be done by using a flashlight inside the firebox and locating the air inlet on the left wall.

Any standard stove cement would be serviceable, but we recommend using HearthStone Stove Cement.

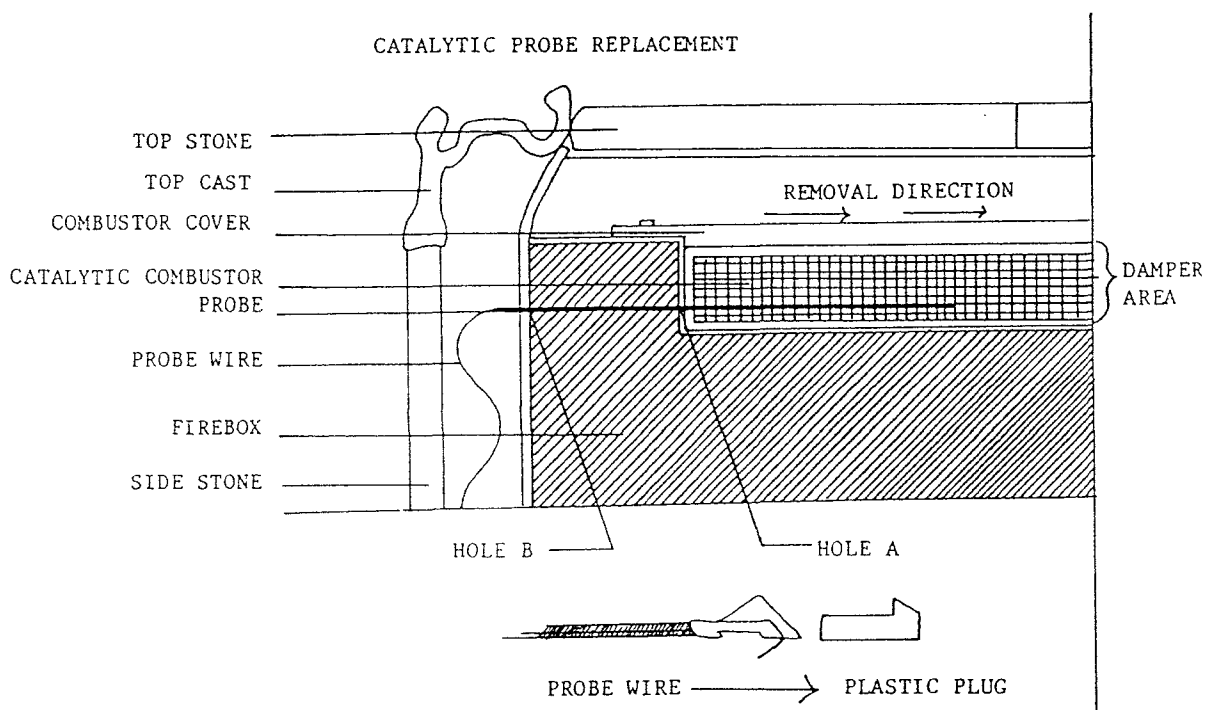

SECTION J: MIXING CHAMBER

Mixing Chamber Inspection and Mixing Chamber Screen Removal

To obtain better rear clearances for the Hearth-Stone III Catalytic, radiation shields have been installed in the mixing chamber at the rear of the stove. These should be inspected for integrity at two year intervals. The shields can be inspected from two directions. The first would be to remove the perforated chamber screen at the back of the firebox by lifting it straight up from behind the spacer guard (See Fig. 9).

With a flashlight inspect the chamber, noting any holes in the innermost shield. (The innermost shield is the only one visible from this direction). The tops of the shields are visible by removing the combustor and shining a flashlight down into the mixing chamber.

Again, note any significant erosion of the stainless steel or holes in the stainless steel. Report any deterioration of this kind to your HearthStone Dealer.

SECTION K: STOVEPIPE AND CHIMNEY

1. Creosote Formation and Need for Removal

When wood burns slowly, it produces tar and other organic vapors which combine with moisture to form creosote. The creosote vapors can condense in a relatively cool chimney flue with a slow burning fire. As a result, creosote residue accumulates on the flue lining. When ignited, this creosote makes an extremely hot fire. Any accumulation of 1/8" or more should be removed immediately.

Because of the many variables that affect how quickly or how much creosote accumulates, it is impossible to state how often it will be necessary to clean your stovepipe and chimney. **Visual** inspection is the only way to tell, so we highly recommend that you install your stove so that inspection every two weeks and necessary cleaning is made as easy as possible. A clean stovepipe and chimney go hand-in-hand with the woodburner's peace of mind.

2. Inspection

Slip-joints and drawbands (See illustration on Page 8) are stovepipe component pieces that make both inspection and cleaning very simple. The slip-joint and/or drawband is most useful when the stovepipe configuration requires that the pieces be dismantled for cleaning outdoors. A small mirror attached at an angle to a long handle allows for easy inspection once the drawband has been removed, or the slip-joint has been dropped.

When inspecting a masonry chimney, the cleanout door, normally found either outside or in the basement at the base of the chimney, is the place to start. A long-handled mirror is once again the best tool for inspection. If your chimney was not constructed with a cleanout door, it must be inspected by either looking directly up through the damper of the fireplace, through a thimble, using a mirror. At times, inspection from the top of the chimney is the only practical method.

If no cleanout in basement disassemble stovepipe and inspect with a mirror here

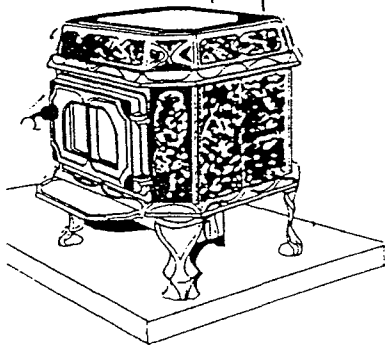

Inspection Mirror

Cleanout Door

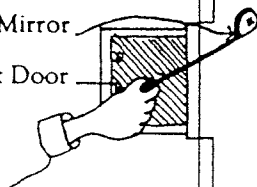

Chimney Inspection and Cleaning

PART VI: SAFETY

SECTION A: GENERAL PROCEDURES

There are certain risks that are taken when using a solid fuel heater, be it Hearth-Stone, or any other stove. These risks can be minimized, however, if proper installation and sensible operating procedures, as outlined in this manual, are followed.

Additionally, we urge you to **use common sense!!** The following is a list of safety precautions:

1. Always keep combustible items (furniture, drapes, curtains, clothing, etc.) a considerable distance from the stove. We recommend a **minimum** of 36".

2. **Do not overfire your stove!!** If the stovepipe and castings of the stove begin to creak, change color, or the porcelainized castings begin to blister, **you are over-firing!**

This can be best avoided by insuring that your ash door is securely closed. We strongly recommend monitoring your stovepipe temperatures with a probe-type thermometer 12 to 18 inches from the stove. Maximum temperatures should not exceed 600°F.

3. Install a smoke alarm.
4. Keep a fire extinguisher handy. We recommend the type rated A,B,C.
5. Ashes should be placed in a metal container with a tight fitting lid. The closed container of ashes should be removed from the house immediately. If the ashes are disposed of by burial in the soil or otherwise locally dispersed, they should be retained in the closed container until all cinders have cooled.
6. Never use gasoline-type lantern fuel, kerosene, charcoal lighter fluid or similar liquids to start or "freshen up" a fire. Keep all such liquids well away from the stove while it is in use.
7. Keep pets and children away from the stove.
8. Inspect your stovepipe and chimney frequently for creosote accumulation and clean it as often as necessary.
9. Never put articles of clothing or candles on a hot stove.
10. Open the ash pan door when the stove is cool. Be sure the bypass damper is open.

SECTION B: EMERGENCY PROCEDURES

In the Event of a Stovepipe or Chimney Fire:

1. Close primary air control.
2. Call the Fire Department.
3. Keep a watchful eye on the stove and connector pipe.

Once the fire has expired, continue to keep all air inlets closed and let the fire in the stove die out completely. **The stove should not be fired again until the stove, stovepipe and chimney are thoroughly inspected for any sign of damage.** Damage should be corrected immediately.

PART VII: TROUBLESHOOTING

Troubleshooting is much easier (and the results much more accurate) if the operator purchases and operates a temperature monitoring device for use with the existing probe.

GENERAL TROUBLE SHOOTING

<u>Problem</u>	<u>Possible Causes</u>	<u>Possible Solutions</u>
Stove smokes through open door or seams.	<ul style="list-style-type: none"> -Insufficient draft. -Plugged perforated screen -Cold chimney. -Blocked chimney. -Fly ash in combustor. -Insufficient air supply. -Use of air insulated chimney. -Oversized chimney. -Undersized chimney. -Too short a chimney. -Air infiltration in chimney. -More than one appliance connected to flue. 	<ul style="list-style-type: none"> Open damper and air intake one minute before opening doors. Scrape fly ash from perforated screen in rear of firebox. Preheat chimney when starting a fire in a cold stove. Burn some paper. Check chimney for blockage, creosote, proper size. Clean combustor with a soft brush. Install outside air source. Use insulated chimney or insulate present one. Reline chimney to appropriate diameter or replace. Install draft inducer or replace chimney. Lengthen chimney. Seal chimney connections and openings, such as, clean-out doors. Disconnect all other appliances and seal openings.
Back puffing/ gas explosions.	<ul style="list-style-type: none"> -Extra low burn rate. -Insufficient draft. -Chimney downdraft. -Closing down air intake too quickly after re-loading on a balmy or wet day. -Excessive ash buildup in stove. 	<ul style="list-style-type: none"> Burn stove in proper operating range. Open damper and air intake one minute before opening door. Install chimney cap or stove-pipe damper. Allow fire to get established before shutting down damper and air intake. Empty ash pan daily.
Short or uncontrolled burn (using wood).	<ul style="list-style-type: none"> -Unsealed or open ash pan door. -Excessive draft. -Loose doors. -Deteriorated door gaskets. -Deteriorated cement seals. -Extra long chimney. -Oversized chimney. -High winds or hilltop location. 	<ul style="list-style-type: none"> Close ash pan door tightly. Adjust latch if necessary. Install stovepipe damper. Adjust door latches. Replace door gaskets. Reseal the stove. Shorten chimney or install stovepipe damper. Reline chimney to proper diameter. Install stovepipe damper.

<u>Problem</u>	<u>Possible Causes</u>	<u>Possible Solutions</u>
Creosote buildup.	-Green wood. -Extra dry wood. -Softwood -Low burn rate. -Air insulated chimney. -Exterior chimney.	Use only dry wood, preferably one year dry. Burn hotter fires. Burn hotter fires. Monitor stove temperature and burn at proper rate. Burn stove hot for 1/2 hour twice a day. Insulate chimney.
Insufficient heat.	-Poor wood (rotten/punky). -Poor draft. -Insufficient air supply. -Faulty or dirty combustor.	Use only wood dry one year. See "Smoking Stove Solutions". Provide outside air source. Inspect Catalytic Combustor. Clean or replace. See Page 13, Section F, <u>Maintenance of Catalytic Combustor.</u>
Loose cement.	-Stove not broken in properly. -Stove used for more than two years.	Reseal stove. Observe break-in procedure. Check for missing or loose cement and reseal.
Warping stove parts/blistering enamel/cloudy glass.	-Overfired stove. -Excessive draft.	Do smoke test to detect air infiltration into stove; Install manual damper.

TROUBLE SHOOTING YOUR COMBUSTOR

<u>Problem</u>	<u>Possible Causes</u>	<u>Possible Solutions</u>
Plugging	-Burning items that produce a large quantity of fly ash. -Poor quality fuel, very wet punky wood. -Combustor deactivated.	Avoid burning cardboard, gift wrap or trash materials. Burn well seasoned wood. Be sure temperature is high enough to activate the combustor (500°F+) before closing bypass damper. Clean or (if necessary) replace combustor.
Substrate peeling	-Extreme temperatures are present in combustor. NOTE: These are symptoms of overfiring and/or flame impingement.	Have draft checked. Install damper if necessary. Monitor the temperature closely to avoid overfiring.
Catalyst deactivated NOTE: Large quantities of smoke and/or creosote are indications of deactivation.	-Burning trash, treated wood, cardboard, coal, chemical solvents or garbage.	Burn seasoned, natural wood. Replace deactivated combustor.
Substrate cracking	-Normal if combustor does not deteriorate further. -Mishandling.	Not a problem, so no solution. Do not remove combustor unless necessary. Handle with care.
Substrate crumbling	-Combustor fired at extreme temperatures. -Excessive draft.	Do not fire combustor above 1600°F. Install a manual damper.

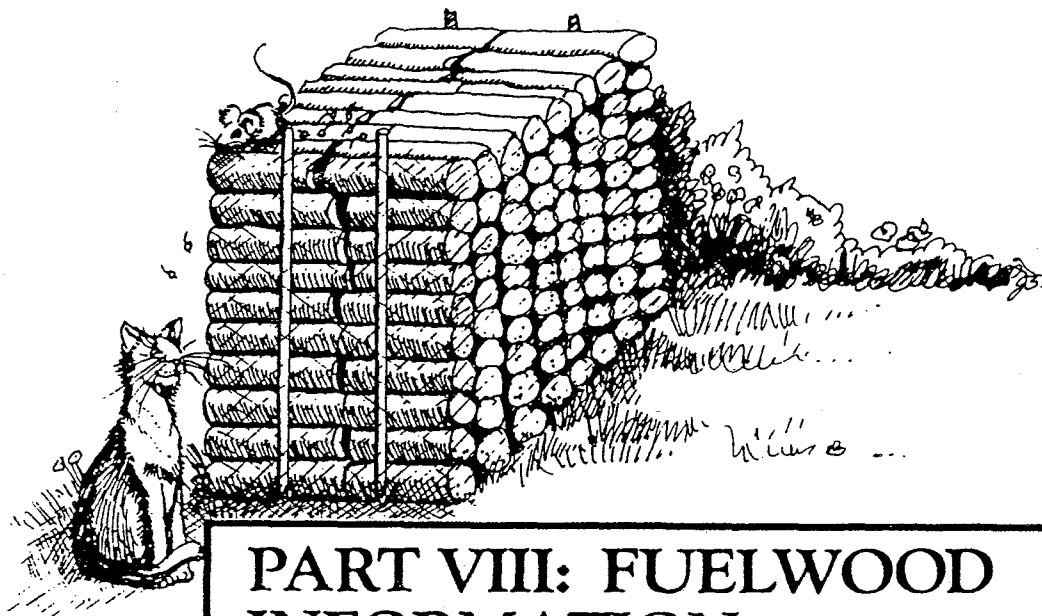

PART VIII: FUELWOOD INFORMATION

The quality of your fuelwood is an important variable which determines both heat output and duration of burn. Softwoods generally burn hotter and faster, while hardwoods burn longer and produce more coals. The **density** of the wood is the critical factor to consider when either purchasing wood or assessing your stove's performance. For your reference, we have provided a list of wood species and their relative BTU content.

HIGH: Ash, Black Birch, Hickory, Hophornbeam, Locust, White Oak, Black Beech.

MEDIUM HIGH: White Ash, Beech, Yellow Birch, Sugar Maple, Red Oak.

MEDIUM LOW: Black Ash, White Birch, Grey Birch, Elm, Norway Pine, Pitch Pine, Black Cherry, Soft Maple, Tamarack.

LOW: White Pine, White Cedar, Balsam Fir, Spruce, Aspen, Basswood, Butternut, Hemlock.

Moisture content also plays a key role in the performance of your stove. Wood that is freshly cut from a living tree (green wood) has a great deal of moisture in it. To properly season green wood, it should be split and stacked on skids or blocks to keep it off the ground, and only the top should be covered. (Plastic or tarps that cover the sides of the woodpile trap moisture and prevent the wood from drying.) As for stacking, an old Vermonter said: "The spaces between the logs should be large enough for a mouse to get through, but not for the cat that's chasing it."

IN CLOSING...

With proper use and care, your new HearthStone III will serve you faithfully. We recommend that you keep this manual in a safe and convenient place and refer to it whenever a question arises. Should you ever have any unanswered questions, problems, or comments concerning your stove, please feel free to call or write us here at HearthStone, or contact your local HearthStone Dealer. We are here to serve you for as long as you own your stove.

If you are planning a trip to Vermont, we cordially invite you to visit us at our factory and see the stoves being built. Morrisville is located in North Central Vermont, On Route 100, 10 miles North of the Stowe resort area. We look forward to meeting you.

Thank you for choosing HearthStone.

We trust that you will enjoy your stove.

NHC, INC.

P.O. Box 1069, MORRISVILLE, VT. 05661 (802) 888-5232 FAX (802) 888-7249

HEARTHSTONE III CATALYTIC SPECIFICATIONS

EPA Maximum Heat Output (1)	14,341 BTUs/hr.
Heat-Life TM (2)	Up to 8 hours
Maximum Combustion Efficiency (1)	90%
Estimated Maximum Heat w/Hardwood	23,000 BTUs/hr.
Size of Heated Volume	Alcove or small room
Fuel Load	1.0 cu. ft.
Fuel Size	10" to 14" mixed
Height	23 3/4"
Width	23 7/8"
Depth	29" (including 4" ash lip)
Door Opening Size	7" X 12 1/2"
Stovepipe Size	6" Diameter
Recommended Chimney Size	6" Diameter (or 8" X 8")
Flue Exit	Reversible Flue Collar
Height to Rear Exit	20 7/8" ± 1/4" to centerline of rear exit
Primary Air/Combustion Control	Spindraft (open-to-close in 1/2 turn)
Secondary Combustion System	Non adjustable supply for combustor
Standard Equipment	Bottom Heat Shield, Wood Grate, Two Handles, Thermocouple Probe
Optional Equipment	Standard or Deluxe Rear Heat Shield, Outside Air Kit, Mobile Home Kit, Matching Warming Shelf
Weight	420 lbs
Shipping Weight	440 lbs
Stone Finish (3)	Natural Buff Grey, Polished, Polished Brown
Cast Finish	Black Castings, Brown Porcelain Enamel

(1) Estimates based on latest Independent Laboratory test results. Area heated and duration of burn may vary from installation to installation.

(2) Heat-Life is a trademark of N.H.C., Inc. and is defined as thermal capacitance or quality of heat stored. Used here, it refers not just to burn time, but also to hour of usable heat obtained from a single load of fuel.

(3) Colors of polished stone can vary from grey to grey green, colors of brownstone can vary from grey brown to brown, all according to natural composition.