

INVINCIBLE "T" OWNERS MANUAL

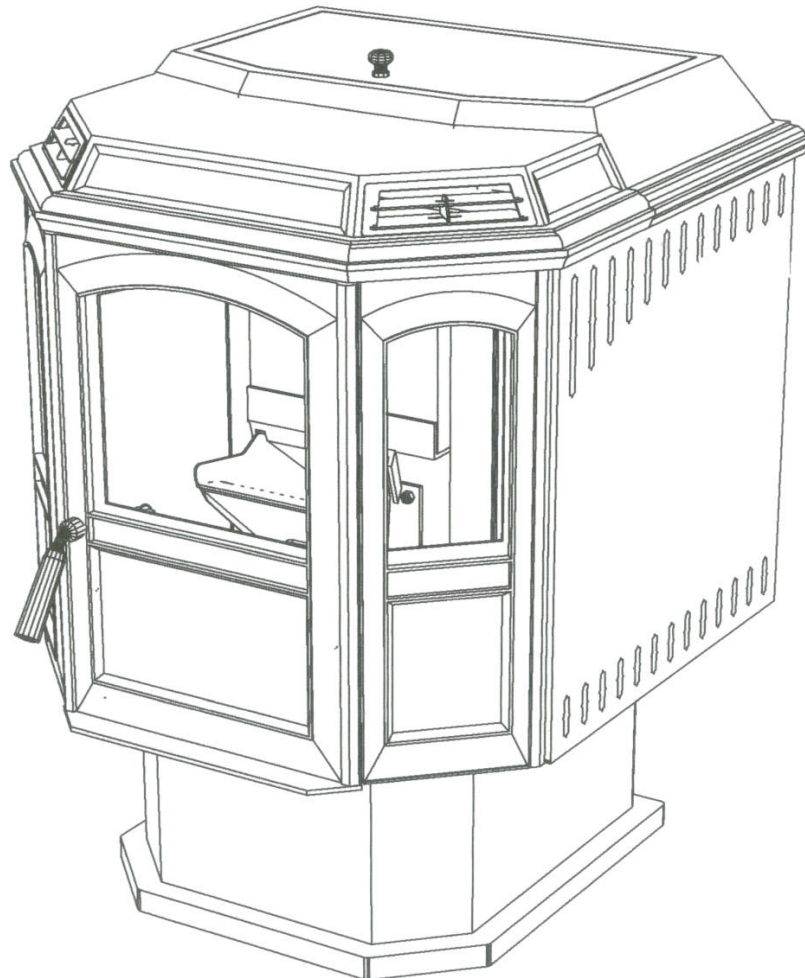

READ THESE INSTRUCTIONS BEFORE INSTALLING OR OPERATING THIS STOVE.

Introduction	3
Packing List	5
Assembly	5
Installation	6
ESP Control	8
Feed Adjustment	9
Operation	10
Low Draft Adjustment	12
Maintenance	13
Trouble Shooting	15
Helpful Hints	16
Fuels	16
Wiring Diagram	16
Specifications	17
Parts List	18

HARMAN STOVE & WELDING, INC.
352 Mountain House Road
Halifax, PA 17032
(717) 362-9080

Introduction

Congratulations and thank you for purchasing an INVINCIBLE!

Your unit was built in Pennsylvania from the finest American-Made steel by excellent craftsmen and welders. There are many inspections and tests to pass on the way from raw steel to the finished product. Evidence of this is the Quality Control Sheet placed in the hopper which notes the final assembly checks.

The INVINCIBLE is designed to last and be virtually maintenance free mechanically. The auger rides on dual heavy duty ball bearings. The pusher assembly rides on heavy bronze bearings. The feed motor has needle bearings on the output shaft and ball bearings on the motor.

The patented Pellet Pro Feeder and Verti-Flow Burn Pot plus the ESP Control make the INVINCIBLE the most advanced pellet stove available.

In this manual we may go into more detail than is necessary. If you get confused don't worry, the instructions inside the ESP control door will help you operate your INVINCIBLE with minimum hassle.

One thing you must remember is sooner or later the stove and flue pipe will need to be cleaned. Refer to the maintenance section for more details.

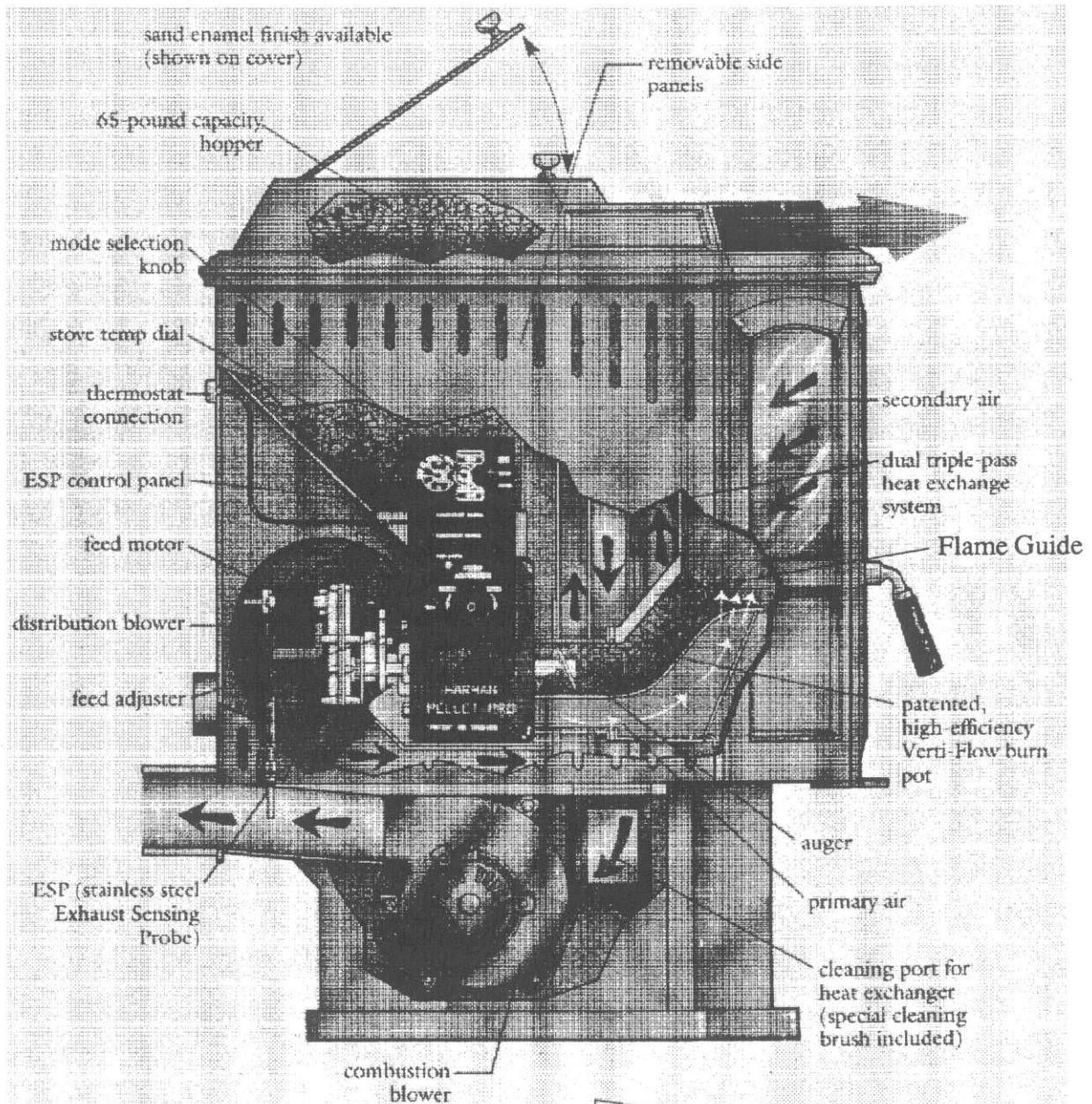

HOW IT WORKS

The INVINCIBLE has a combustion blower which provides negative pressure in the firebox. This causes primary air to be drawn in through the holes in the burn pot. Secondary air is drawn in the slots around the glass and provides an air wash to keep the glass clean.

The combustion blower uses a variable speed motor to regulate the draft from high to low depending on the rate of burn.

The ESP (Exhaust Sensing Probe) Control monitors the temperature through a stainless steel temperature probe in the exhaust gases.

The PELLET PRO feeder takes pellets from the hopper and meters them into the auger with an adjustable stroke pusher block. The auger feeds the pellets into the Verti-Flow Burn Pot where they get air provided by the combustion blower.

The feeder and combustion blower are regulated by the ESP Control. This control varies the pellet flow and air flow to meet the heating demands of the thermostat.

The following manual uses illustration when possible and is designed to be easy to understand.

Packing List

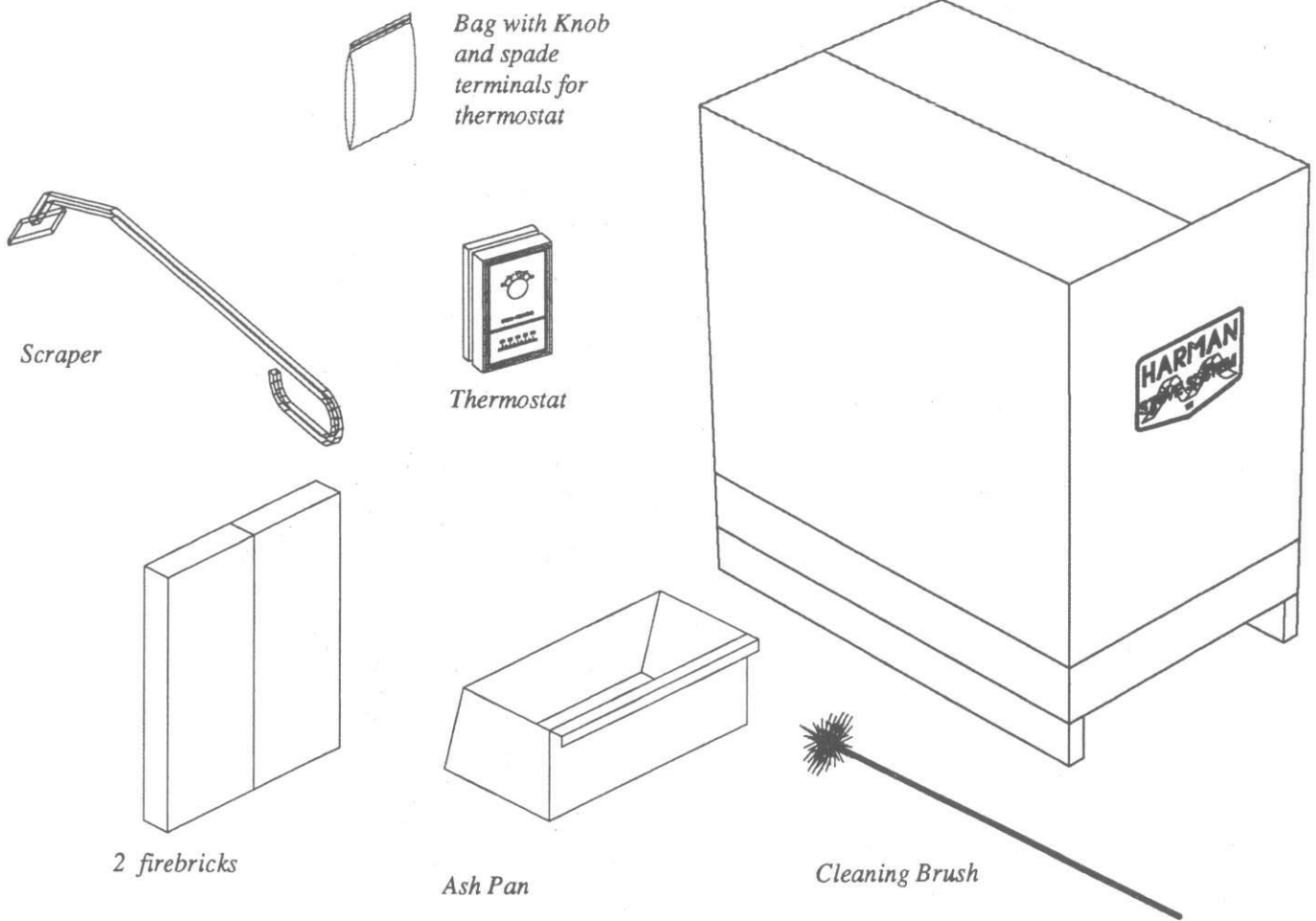

Assembly

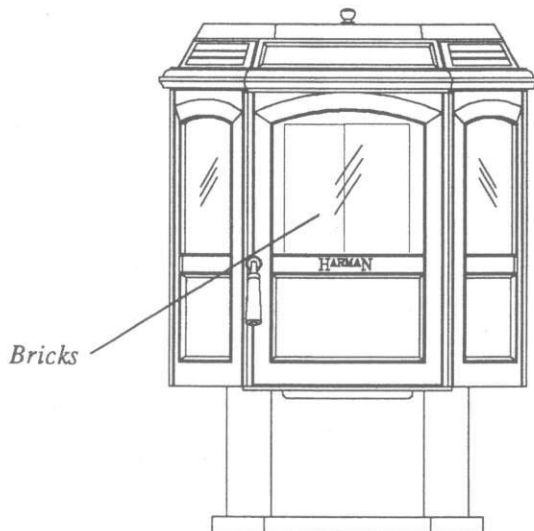

Install knob on hopper lid.

Place the two firebricks that are shipped in the ash pan, across the rear of the firebox just above the burn pot. There is an angle iron holder to set the bricks in. The bricks are held in place by gravity and may come out of position if the unit is moved. It is therefore recommended that the bricks be installed after the unit is in position.

Check the Flame Guide shown on page 4 to see that it is in position.

Installation

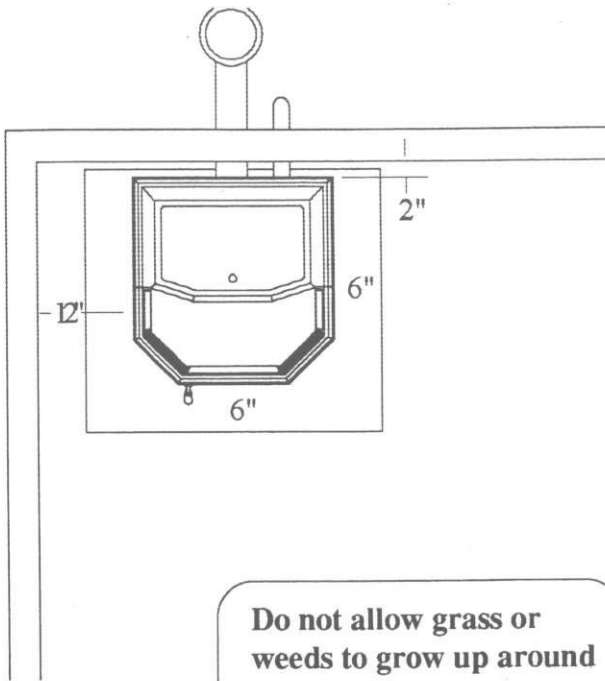

Do not allow grass or weeds to grow up around the flue outlet. This could cause a grass fire.

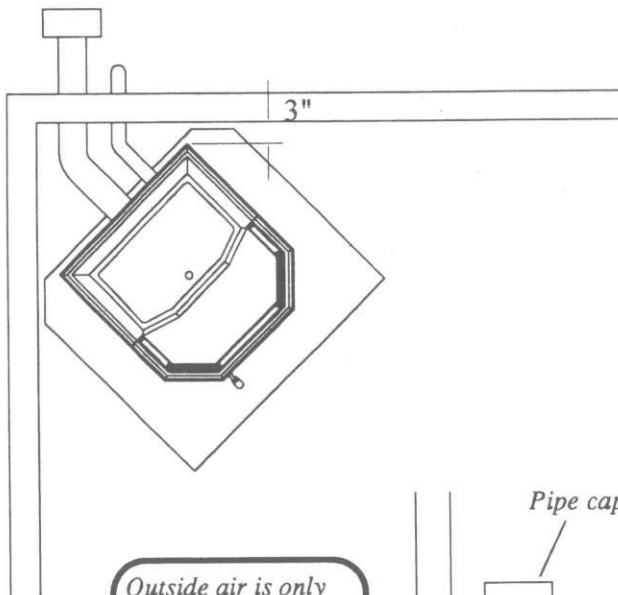

Outside air is only mandatory for mobile home installations.



Place the unit on a noncombustible floor or a noncombustible floor protector. The floor protector should extend from the unit 6" on each side, 6" to the front, and 1" to the rear of the unit as shown.

The clearance to combustible walls is 12" on the sides and 2" to the rear of the hopper. In a corner installation the unit may be placed 3" from the corners of the hopper to the wall.

The vent pipe shall be UL listed and designed for pellet stoves. The diameter of the INVINCIBLE vent is 3". The vent may go straight through a combustible wall if the proper thimble is used. We recommend the same brand of thimble and vent pipe be used. It is best if no more than two elbows are used to get through the wall. Outside we recommend that the vent extend 12" beyond the wall. **A vertical section of three to five feet should be added to provide some natural draft in the event of a power failure or combustion blower failure. If this vertical section is not installed smoke may escape from the stove.** In either case a cap must be used to prevent wind from blowing in the pipe. Be sure to support any vertical sections.

The unit may also be vented into a fireplace flue or a chimney. In the case of a fireplace the vent should extend through the damper area and be sealed so gases cannot come back into the house.

An outside air intake is provided on the side of the feeder. Two inch sch 40 plastic pipe (found at most hardware stores) may be used to run outside. This is most beneficial in small tight houses and mobile homes. If the house is too tight it will not allow air to flow freely through the stove causing poor combustion.

In a mobile home installation outside air is mandatory. Also in a mobile home the unit must be bolted to the floor. This can be done by drilling a hole in the bottom center of the stove pedestal and running a bolt of sufficient length down through the floor protector and floor. Do not over-tighten this bolt.

The INVINCIBLE has a power cord which gets connected to 115 AC volt 60 hertz outlet. This is standard in the U.S.A.

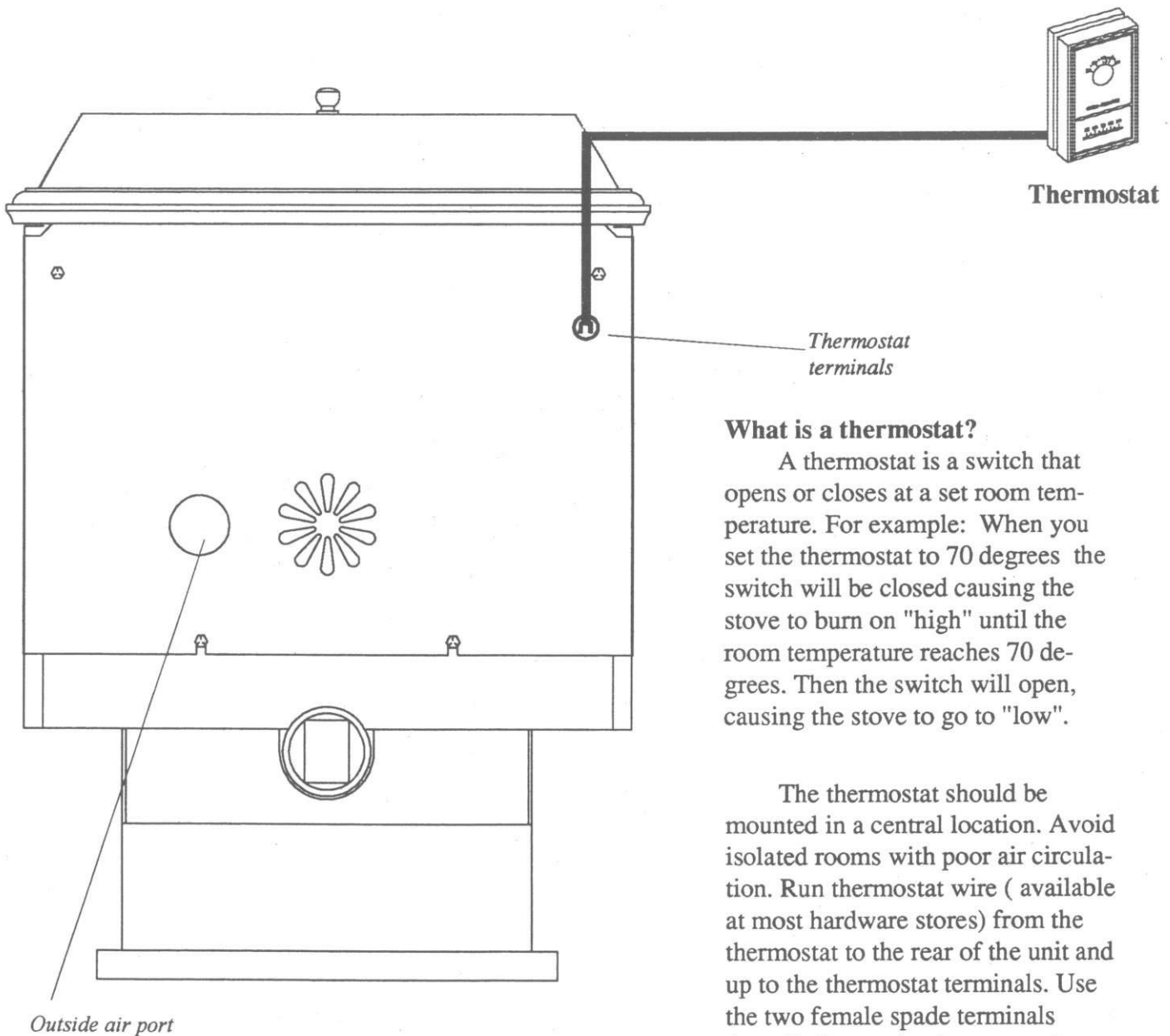

What is a thermostat?

A thermostat is a switch that opens or closes at a set room temperature. For example: When you set the thermostat to 70 degrees the switch will be closed causing the stove to burn on "high" until the room temperature reaches 70 degrees. Then the switch will open, causing the stove to go to "low".

The thermostat should be mounted in a central location. Avoid isolated rooms with poor air circulation. Run thermostat wire (available at most hardware stores) from the thermostat to the rear of the unit and up to the thermostat terminals. Use the two female spade terminals (supplied) to make the connection.

ESP CONTROL SYSTEM

ESP stands for Exhaust Sensing Probe. The Pellet Pro II uses a stainless steel probe extended into the flue gases to sense the temperature. This would be similar to checking your heart rate. The probe sends information to the control board where decisions are made as to how fast or slow to run the combustion and distribution blowers and also when to feed more pellets.

The control has a **Mode Selector Knob** with two mode positions. These are **Stove Mode** and **Thermostat Mode**.

In **Stove Temp Mode** the temperature of the stove is adjusted by simply turning the stove temp dial to the desired setting between 1 to 7. The distribution blower speed will increase as the stove temperature increases and decrease as the stove temperature decreases.

In **Thermostat Mode** the temperature of the stove is controlled by a wall thermostat. In this mode the stove will make only enough heat to keep the room at the set temperature. The distribution blower speed will increase as the stove temperature increases and decrease as the stove temperature decreases, if the thermostat is calling for heat. If the thermostat is satisfied the distribution blower will stop. In thermostat mode the stove temp dial limits how low the stove temperature may go. In most cases the dial should be turned to the 1 or 2 position depending on the quality of the pellets. The better the pellets the lower the setting can go without causing the fire to go out.

In Thermostat Mode with the thermostat calling for heat, the stove will run on "high"* continuously until the maximum allowable temperature is reached. The stove will then cycle from "high" to "low"* to keep from exceeding this temperature.

The **Start** button is for starting a fire. Pressing the green start button will run the combustion blower on high. When you light a fire the exhaust temperature will rise as more pellets ignite. When

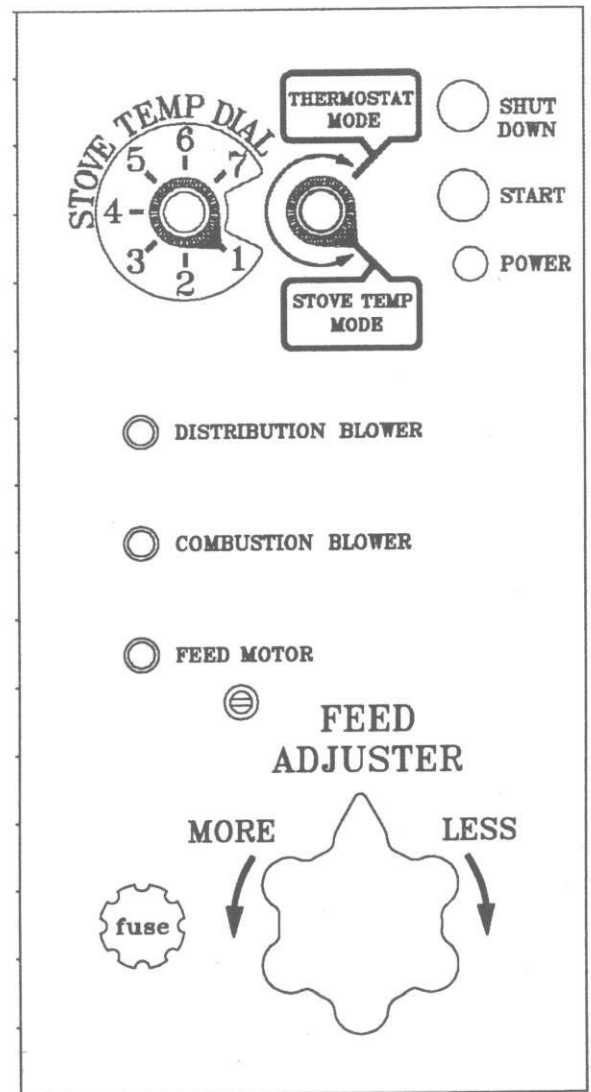

the exhaust gases reach the proper temperature the feed motor will start and normal operation will begin.

The **Shut Down** button is to extinguish the fire and totally stop the system.

Turn the Feed Adjuster to zero and press the red "Shut Down" button. The combustion blower will go to low and the feed motor will stop. When the ESP control senses the fire is out, everything will stop.

The red indicator lights tell if power is supplied to the various motors.

* "High" is when the feed motor light is on and the combustion blower light is on.

** "Low" is when the feed motor light is off and the combustion blower light is off.

Feed Adjustment

The feed adjuster is used to adjust the feed rate. **The feed rate is the number of turns counterclockwise from zero.** Zero is determined by turning the feed adjuster clockwise until a positive stop is reached. If adjustment is made while the feeder is running the resistance will change while turning the adjuster. Do not mistake this change in resistance for zero. The greater the number of turns from zero the greater the feed rate. The adjuster can be set in fractions of a turn thus providing infinite adjustment.

Too high a feed rate will push partially burned pellets off the end of the burnpot and may cause visible smoke exhaust.

Too low a feed rate may not produce enough heat.

The feed rate determines the maximum heat output possible.

At a high burn rate, 1" of ash is desirable. Any larger amounts of ash at a lower burn rate is normal.

Use the number of turns from zero as a reference to the maximum feed rate. For example, if 6 turns produce 1" of ash in front of the fire, you know never to exceed 6 turns. Use less than a maximum feed rate unless you need full output. This will conserve fuel and help keep the glass clean longer.

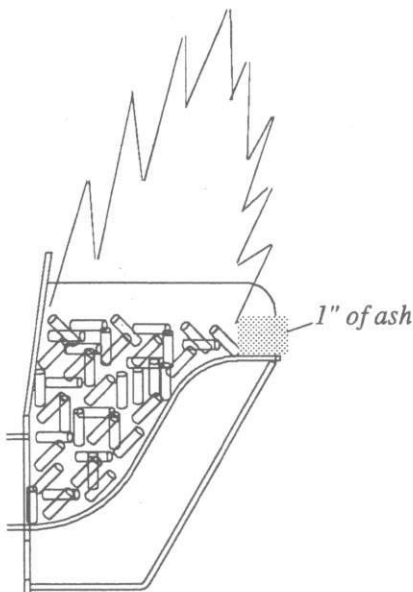
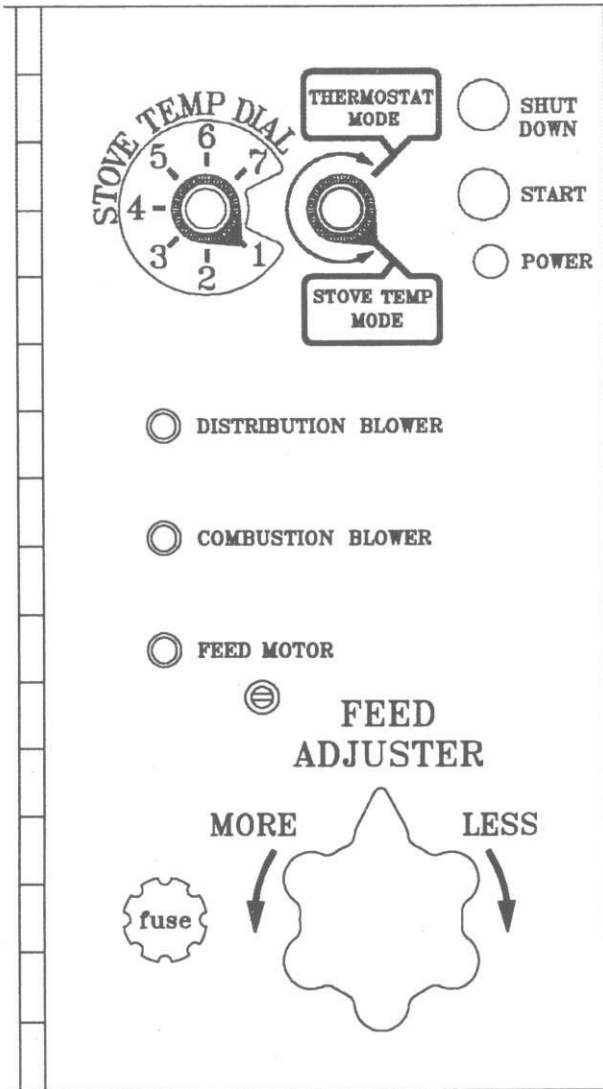

Maximum feed rate

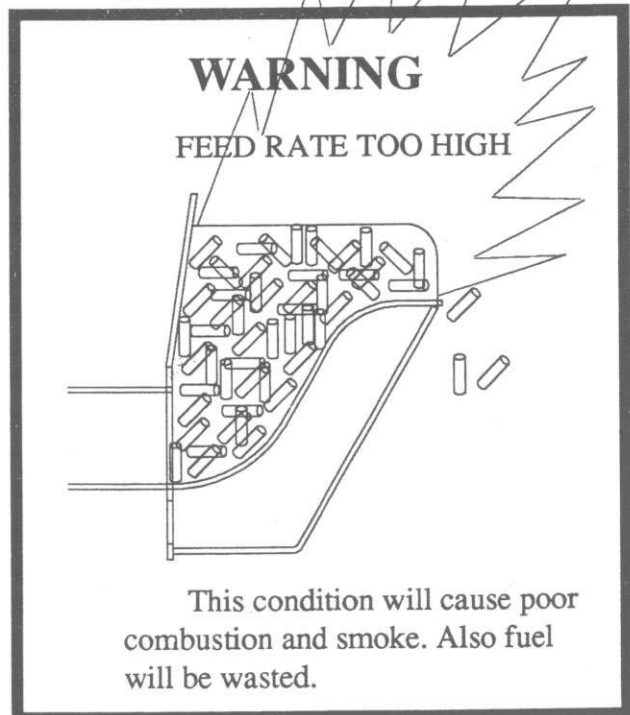

Starting a fire

Be sure the power cord is plugged into a 120 volt receptacle. This can be verified by the red power light on the control panel.

Clean burn pot with scraper (supplied).

Fill the hopper with pellets.

Fill the burn pot with pellets to a level just short of overflowing.

Adjust feed rate. If this is your first fire or you are trying different pellets, turn the feed adjuster knob clockwise as many turns as possible until you reach a definite stop. Then back off five turns. This is a conservative number and will probably need to be increased. After you know what feed rate you want, use that setting. Remember, feed rate is the number of turns counterclockwise from zero.

Press green start button. This will turn the combustion blower to high.

Apply starting gel to pellets in burn pot and **light** the gel. Close the door after lighting.

At this point the distribution and combustion lights will be on and the feed motor light will be off. As the temperature of the fire increases, the feed motor light will come on and pellets will feed into the burn pot. As the stove temperature increases the distribution blower speed will increase.

After 30 to 45 minutes it may be necessary to **readjust the feed rate.** The feed rate should be adjusted so there is about one inch of ash in front of the fire.

Select mode by turning the Mode Selector to Stove Temp Mode or Thermostat Mode.

**NEVER PULL THE PLUG
TO KILL THE FIRE**

When to use "Stove Temp Mode"

In "Stove Temp Mode" the Stove Temp Dial determines the temperature of the stove. Heat output and fuel consumption will remain constant. This makes it possible to tell how long a hopper full of pellets will last. The distribution blower speed will vary automatically according to stove temperature.

When to use "Thermostat Mode"

In "Thermostat Mode" heat output is controlled automatically by the thermostat. When the thermostat calls for heat, the stove will go to high output. When the thermostat is satisfied, the stove will go to low output.

High output is determined by the feed rate. The maximum feed rate should be set for 1" of ash in front of fire.

Low output is determined by the Stove Temp Dial. Normally a setting of 1 or 2 is recommended. Setting 1 may not work well with low grade pellets. This is no reason not to burn them though, simply use a higher setting. If you use too high a setting, such as 4 or 5, the stove may be too hot on low and exceed the desired room temperature.

In "Thermostat Mode" fuel consumption is sacrificed for exact room temperature. Therefore, as it gets colder more pellets will be burned automatically.

Safe Shut down Procedure

To kill the fire or stop burning the stove, do the following with the feed motor light on.

1. Turn the Feed Adjuster to zero.
2. Press the red "Shut Down" button.

This procedure will purge the auger tube of pellets which will make the stove cool faster. When the fire burns out and the stove cools down everything will stop.

If you pull the plug to shut down the stove all motors will stop. This may cause incomplete combustion and smoke in the firebox. If the load door is opened the smoke may escape.

The best way to shut down the stove is simply let it run out of pellets then the stove will shut down automatically.

The INVINCIBLE operates at varying sound levels and types of sounds depending on the mode of operation. This is normal and is not a problem.

Be sure hopper ledge is free of pellets before closing the lid. Pellets on the ledge will make the fire burn towards the glass and make it dirty.

Keep stove top free of pellets

When filling hopper with pellets, do not jam pellets around hopper lid hinges. It is best to let a little space around the hinges to insure a good hopper lid seal.

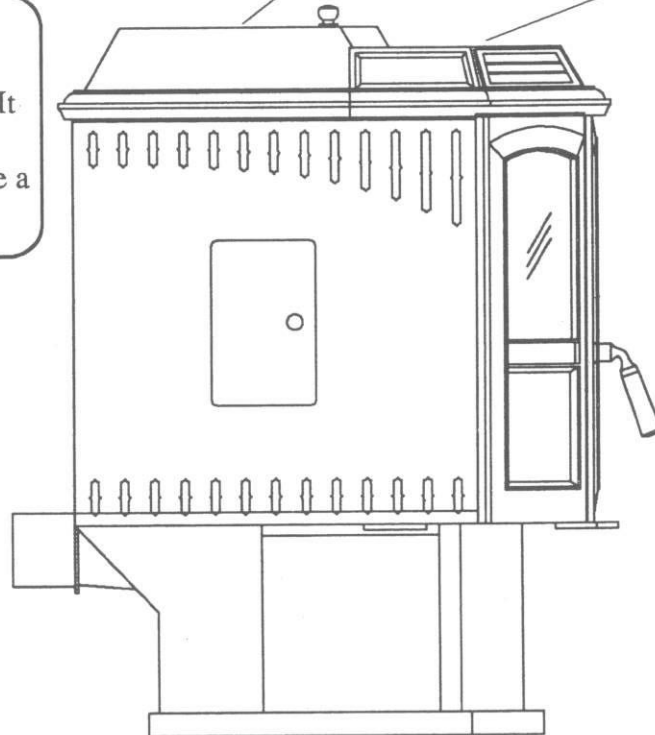

Plastic pellet bags may melt if they touch the stove part of the unit.

Always wear gloves when removing ashes, filling hopper or cleaning the glass.

Do not allow grass or weeds to grow up around the flue outlet.

This unit has been designed and tested to be operated with the door closed. The door should only be opened to remove ashes. Normally the door open time to remove the ashes is less than 10 seconds and does not pose a problem. Keep hopper lid closed except for loading.

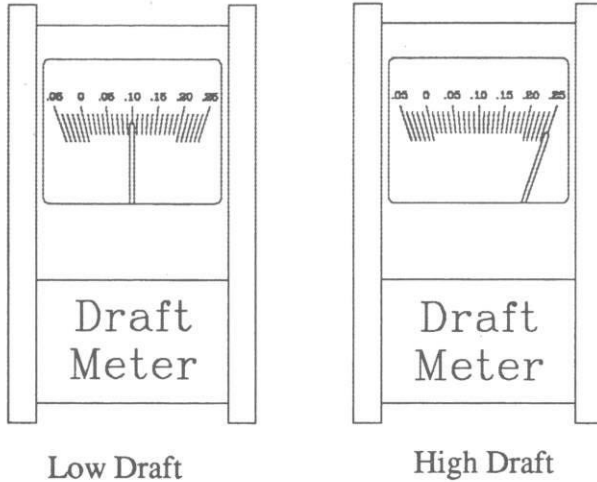

Low draft adjustment

The low draft adjustment is factory set to be higher than necessary for most installations. This is because it is much better to be too high than too low. In some cases, further adjustment may be beneficial. The purpose of this adjustment is to regulate the height of the flame on low burn.

Turning the adjustment clockwise will increase flame height.

Turning it counterclockwise will make the flames shorter to the point the flames go out.

To make adjustments, the fire must be on low burn. Low burn can be verified by a lower flame and the feed motor light will be off. Stove Temp Mode with about a number 3 setting on the Stove Temp Dial is good for this purpose. Make only small adjustments with a small screw driver. **Do not adjust so low that the flame goes out.**

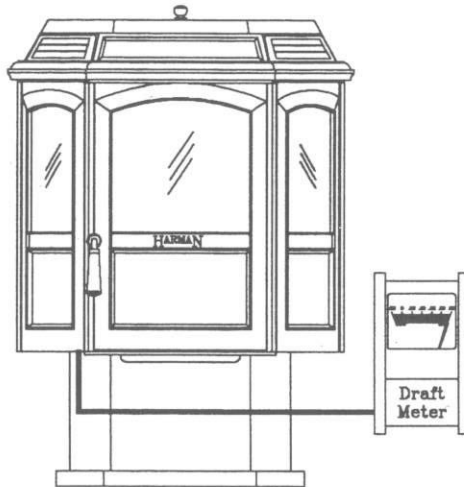

The ESP Control **will** allow the flames to go out under the following conditions:

In Stove Temp Mode when you turn the dial from a high setting to a low setting.

In Stove Temp Mode when the stove temp dial is set at 1 or 2.

In Thermostat Mode when the thermostat is satisfied and the fire goes to low burn.

In all these conditions the fire will be burned back into the throat of the burn pot. At this point the pellets will be glowing embers and will not smoke.

The low draft setting is more likely to need adjustment if the stove is connected to a chimney.

This is because the chimney makes draft in addition to that of the stove or maybe it has a down draft problem.

The best way to adjust the low draft is with a draft meter. To do this, put the draft meter on a level surface and zero the needle. Remove the bolt from under the left bottom of the stove. Insert the meter tube. The meter should read .35 on high and .12 to .15 on low (cold). This draft reading must be done without fire in the stove. We do not expect you to have a draft meter, therefore, have your dealer check the draft if you suspect a problem.

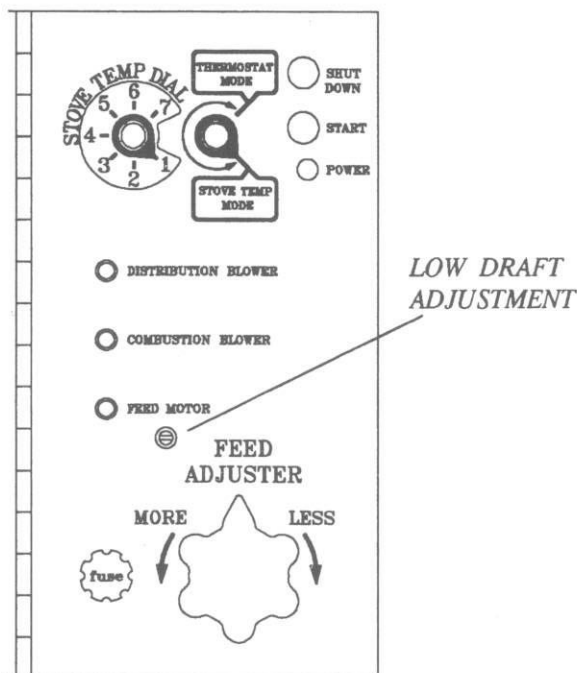

Maintenance

NEVER PULL THE PLUG TO KILL THE FIRE.
Always use Shut Down Procedure.

ESP

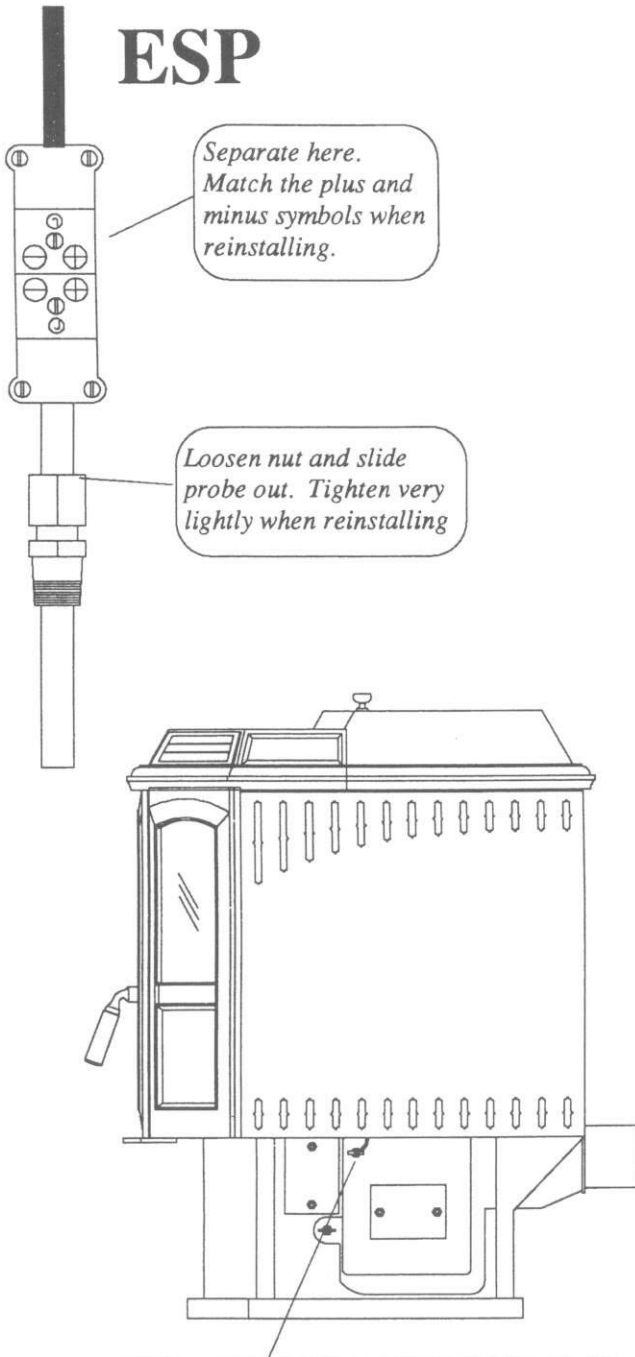

To remove Stainless Steel ESP probe (located here) first remove the side panel on the pedestal. Next remove wire from probe, loosen nut shown above and slide out the probe. Install in reverse order and be sure to **only make the nut snug.**

The INVINCIBLE is designed to need little maintenance mechanically. However, **The stove must be cleaned when needed to maintain top performance.**

AS NEEDED

1. Fill hopper and remove ashes.
2. Clean burn pot (scrape carbon loose with scraper). If the fire is pushing out more in the middle of the burnpot than before or even pushing partially burned pellets off the edge, these are indications that the burnpot needs cleaned.
3. Clean glass (Always wear gloves).

ANNUALLY (or as needed)

1. Oil blower motors with only a few drops of light oil (too much oil is worse than none).
2. Clean fly ash from heat exchanger tubes with brush as shown on page 14. There are four vertical tubes, two on each side and a horizontal tube.
3. Remove and clean ESP probe.
4. Remove and clean combustion blower assembly as shown on page 14. Be careful not to tear gasket.
The blower is sealed to the mounting plate with silicone and will need to be pried loose if the blower ever needs to be replaced. When remounting the blower be sure to seal the intake and outlet with RTV silicone (available at most hardware and auto parts stores).
6. There two baffles inside the firebox, (one on each side). There is a hole at the bottom of each baffle for inspection and fly ash removal. If you see fly ash build-up through the hole, remove it with a vacuum cleaner. If build-up is excessive the baffles can be removed with one bolt each.
5. Open burn pot clean-out slide and allow fly ash to fall out.

Maintenance (continued)

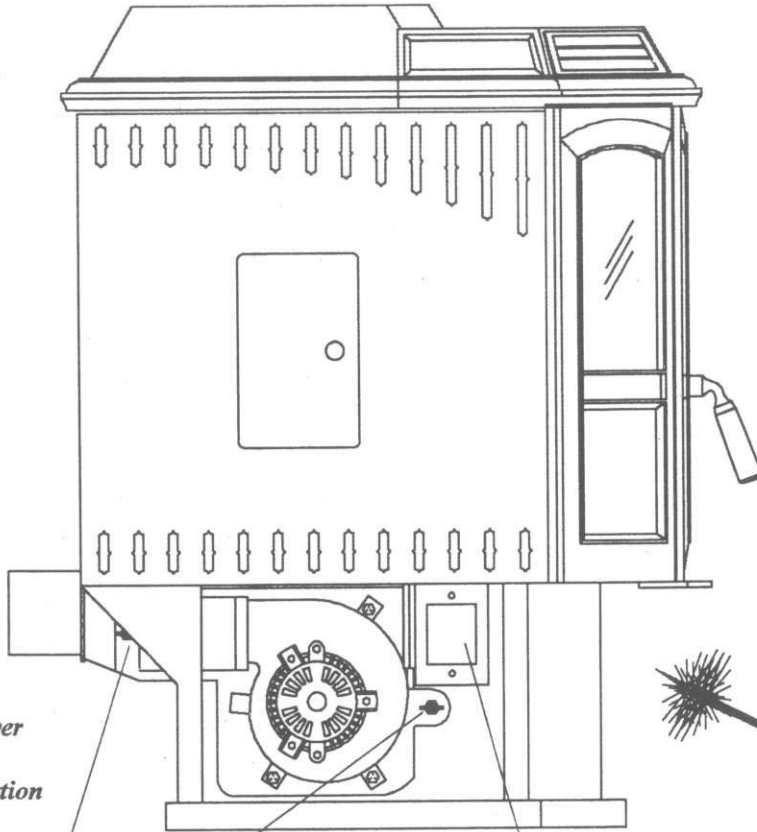

Disconnect main power cord to stove before removing the combustion blower.

Remove thumb nuts and remove blower assembly. You do not have to disconnect the wires to do this, they are long enough to allow removal.

Remove covers and brush all tubes including the flue. It is good to have a vacuum cleaner handy to clean up fly ash. (Two tubes, each side. One inside, one outside.)

Flexible brush

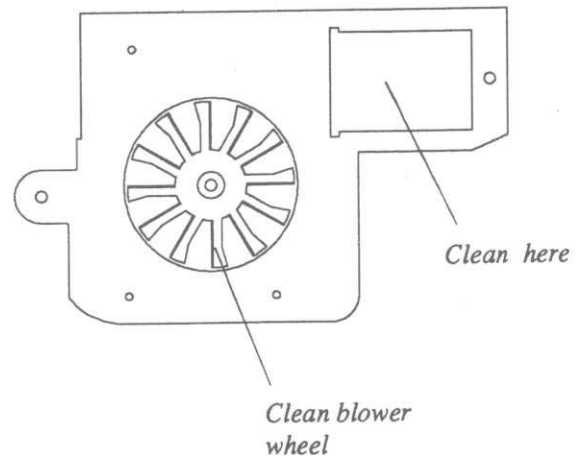
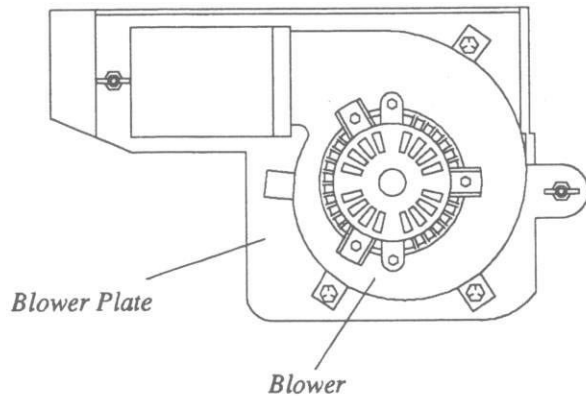

Trouble Shooting

FEEDER DOES NOT FEED

1. No pellets in hopper.
2. Feed motor will not run until ESP senses 165 deg. F. Maybe you did not put enough pellets in the burn pot before lighting the fire.
3. Feed motor has failed.
4. Stove is hot enough.
5. Something is restricting flow in the hopper.
6. Pusher block not pushing full stroke. (See Note #1 below.)

PARTIALLY BURNED

1. Feed rate too high.
2. Draft too low. (Check burn pot clean out slide and door gasket).
3. Combination of both.

SMOKE SMELL

1. Seal the vent pipe joints and connection to stove with silicone.

NOTE #1:

Due to the "fines" (sawdust and/or foreign materials from pellets) in all pellets, a potential sticking pusher block could occur. If this does occur, the remedy is as follows:

1. **UNPLUG STOVE FIRST!**
2. Empty the hopper.
3. Turn the "feed control" counter-clockwise 12 turns.
4. Take off the back panel of stove.
5. Disconnect the spring on the pusher arm. (Part #1-10-02032 on page 18.)
6. If bearing behind gear motor is pushing on pusher arm, spin the black propeller with your finger until bearing is horizontal.
7. This will allow pusher arm to move up and down approximately 2 1/2".
8. Vigorously shake pusher arm up and down about 10-15 times.
9. This should break free any pellet material jamming pusher block.
10. Reconnect spring.
11. Replace back panel.
12. Reset "feed control" knob to desired setting.
13. Unit is now ready for operation.

FIRE HAS GONE OUT

1. No pellets in hopper
2. Feed rate too low.
3. Something is restricting fuel flow.
4. Feed motor or draft motor has failed.
5. Power failure.

SMOKE IS VISIBLE COMOUT OUT OF VENT

1. Air-fuel ration is too rich.
 - A. Feed rate too high.
 - B. Draft too low.

LOW HEAT OUTPUT

1. Feed rate too low.
2. Draft too low because of door gasket leak.
3. Combination of 1. and 2.
4. Pusher block not pushing full stroke. (See Note #1 below.)

FEED ADJUSTMENT MUST BE INCREASED TO GET SAME HEAT OUTPUT

1. Pusher block not pushing full stroke. (See Note #1 below.)
2. Stove needs to be cleaned. Refer to "Maintenance" section.

Wiring Diagram

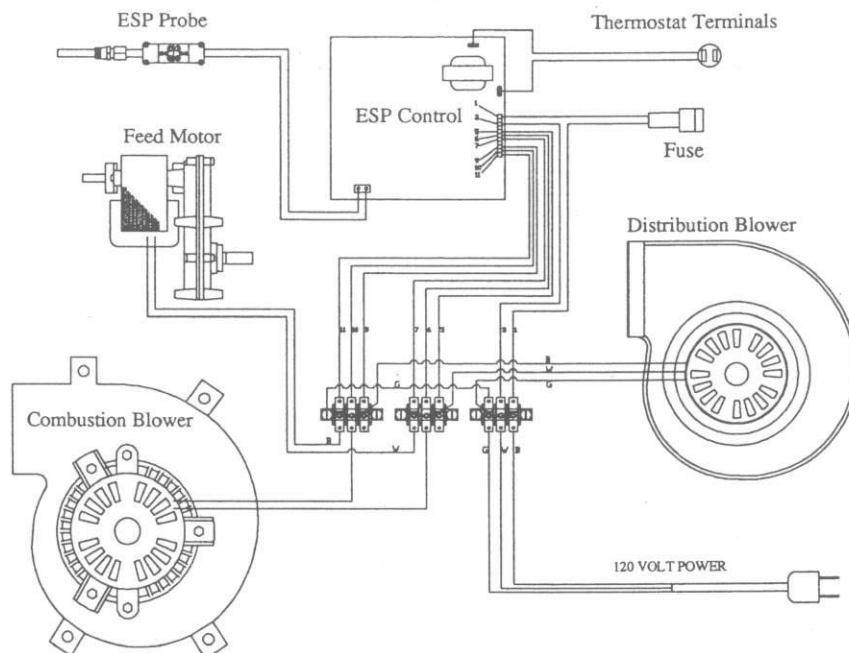

Helpful Hints

Cleaning Burn Pot

Whenever your stove is not burning, take the opportunity to scrape the burn pot to remove carbon buildup. A vacuum cleaner is handy to remove the residue. Be sure the stove is cold if you use a vacuum.

Carbon buildup can be scraped loose with the fire burning using the special tool provided with your stove. Scrape the floor and sides of the burn pot. The carbon will be pushed out by the incoming fuel. Always wear gloves to do this.

Removing Ashes

Turn the Stove Temp Dial to number 1 approximately 30 minutes before removing ashes. This will result in a cooler stove and ash pan.

Maximum settings are not needed in most cases.

Never adjust the feed and draft so low that the flame goes out.

Keep the stove free of dust and dirt.

Always remember the number of turns for maximum feed rate.

PLEASE NOTE: KEEP IN MIND THAT YOU ARE BURNING A SOLID FUEL (BIO-MASS FUEL) AND FLY-ASH FROM THE EXHAUST COULD OCCUR. DURING INSTALLATION PROCEDURE, EFFECTS ON EXTERIOR OF STRUCTURE MUST BE TAKEN INTO CONSIDERATION.

"WARRANTY ACTIVATION COUPON" IS VITALLY IMPORTANT!! PLEASE BE SURE YOU COMPLETE AND MAIL IT TO THE MANUFACTURER!!

Fuels

All wood pellets
Cardboard pellets
Walnut shell pellets
Wood nuggets

The INVINCIBLE is not limited to these fuels. We are constantly testing new fuels.

Specifications

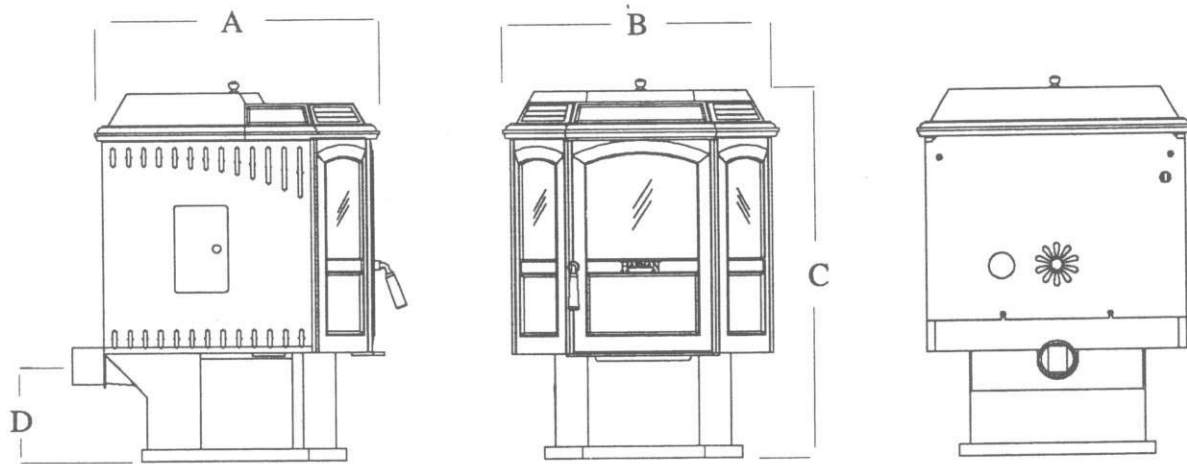

Weight	415 lbs.
Blower size	134 cfm
Hopper Capacity	65 lbs.
BTU range	7000 to 55,000
Heating Capacity	1800 sq. ft.
Fuel	Wood pellets and other similar fuels
Flue size	3"
Outside air size	2" sch 40 plastic pipe
Fuse rating	3 amp
A	26 1/2"
B	25 1/2"
C	34 1/4"
D	9"

Parts

Burn Pot Assembly	1-10-11414	Pusher Arm Spring	3-31-00092
Clean-out Slide	2-00-02012	Feed Motor	3-20-9L041
Cast Iron Flame Guide	3-00-00225	Feed Motor Mount	2-00-01534
Burn Pot Gasket	3-40-00409	Cam Arm Assembly	1-10-00381
Burn Pot Scraper	2-00-03158	Cam Arm Bearing	3-31-3014
Feeder Assembly	1-10-00353	Rubber Grommet	3-31-2761
Pusher Arm Weldment	1-10-00369	Feeder Mounting Gasket	3-40-00408
Auger Weldment	3-50-00419	Ash Pan	1-10-00144
Auger Bearing Housing	3-50-00413	ESP Control Board	3-20-00600
Auger Bearings (2)	3-31-00412	Wiring Harness	3-20-00601
Auger Mounting Flange	2-00-04035	Fuse	3-20-00604
Feed Adjustment Cover	1-10-00063	Thermostat	3-20-120V0
Feed Adjuster	1-10-00285	ESP Probe Assembly	1-10-00167
Feed Adjuster Spring	3-31-00013	Combustion Blower	3-21-07021

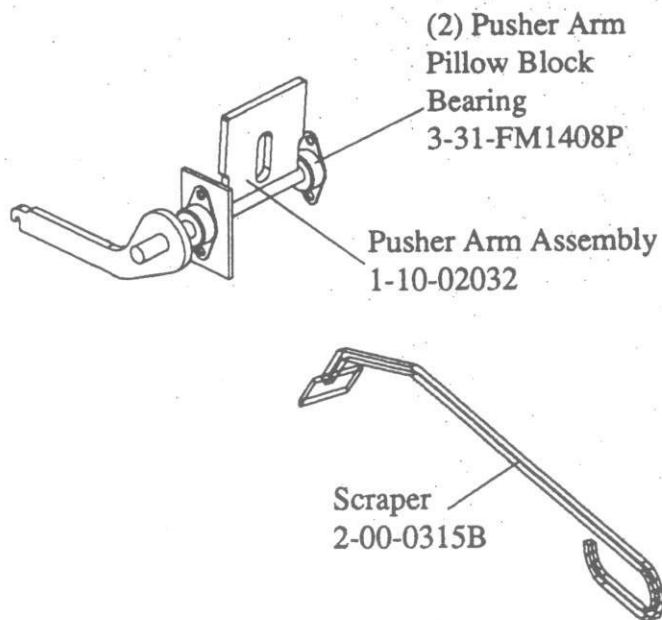



1 Year Limited Warranty (Commercial) 5 Year Limited Warranty (Residential)

Warranties are not transferable. Harman Stove Company warrants its products to be free from defects in material and workmanship, in normal use and service, for five (5) years from the date of sales invoice.

If defective in material or workmanship, and if removed by the owner within 60 months of installation, Harman Stove Company will, at its option, repair or replace the product as described below.

The warranty above constitutes the entire warranty with respect to Harman Stove Company product. HARMAN STOVE COMPANY MAKES NO OTHER WARRANTY, EXPRESS OR IMPLIED, INCLUDING ANY WARRANTY OF MERCHANTABILITY, OR WARRANTY OF FITNESS FOR A PARTICULAR PURPOSE. No employee, agent, dealer, or other person is authorized to give any warranty on behalf of Harman Stove Company. This warranty does not apply if the product has been altered in any way after leaving the factory. Harman Stove Company assumes no liability for "resultant damages of any kind" arising from the use of its products. In addition, the manufacturer shall be held free and harmless from liability from damage to property related to the operation, proper or improper, of the equipment. THERE ARE NO OTHER WARRANTIES WHICH EXTEND BEYOND THE DESCRIPTION ON THE FACE HEREOF.

THESE WARRANTIES APPLY only if the device is installed and operated as recommended in the user's manual.

THESE WARRANTIES WILL NOT APPLY if damage is caused by abuse, accident, improper installation, negligence, or use beyond rated capacity.

SERVICE LABOR RESPONSIBILITY - In furnishing replacement parts, Harman Stove Company assumes no responsibility for any labor expenses, for service removal or reinstallation.

HOW TO MAKE A CLAIM - Any claim under this warranty should be made to the dealer from whom this appliance was purchased. Then contact is made with the manufacturer, giving the model and serial numbers, the date of purchase, your dealer's name and address, plus a simple explanation of the nature of the defect.

SHIPPING COSTS - The transportation charges are as follows:

- (1) Customer prepays freight back to factory.
- (2) Harman Stove Company prepays the repaired or replaced stove freight charges.

NOTE: Prior approval by phone or in writing shall be made before shipping entire unit to manufacturer.

THIS WARRANTY IS LIMITED TO DEFECTIVE PARTS - REPAIR AND/OR REPLACEMENT AT OUR OPTION AND EXCLUDES ANY INCIDENTAL AND CONSEQUENTIAL DAMAGES CONNECTED THEREWITH.

WARRANTY EXCLUSIONS: (1) Labor (2) Ceramic Log Sets (3) Battery Back-ups (4) Firebrick (5) Door Packing (6) Paint (7) Glass (8) Flame Guide and Insulator (9) Acts of God

PLEASE READ THE LITERATURE BY THE MANUFACTURER FOR THE VARIOUS ACCESSORY DEVICES. THESE DEVICES ARE "WARRANTED BY THE MANUFACTURER" NOT BY HARMAN STOVE COMPANY. FURTHERMORE, THESE ACCESSORY DEVICES MUST BE INSTALLED AND USED ACCORDING TO THE RECOMMENDATIONS OF THE MANUFACTURER.

Some states do not allow the exclusion or limitation of incidental or consequential damages, so the above limitation or exclusion may not apply in your state.

This warranty gives you specific legal rights, and you may also have other rights which vary from state to state which may be enforceable in a Court of Law.

REMEDIES - The remedies set forth herein are exclusive, and the liability of seller with respect to any contract or sale of anything done in connection therewith, whether in contract, in tort, under any warranty, or otherwise, shall not, except as herein expressly provided, exceed the price of the equipment or part of which such liability is based.

CLARIFY - The above represents the complete warranty which is given in connection with stoves manufactured by Harman Stove Company. No other commitments, verbal or otherwise, shall apply except by a written addendum to this warranty.