

“Save These Instructions”



Glow Boy™

Pellet Shop & Home Heaters

Owners Manual

ACU^TRON CONTROL II or III w/Memory & Fan Trim



Responsible Resource Development

**Toll Free Technical Support
1 - 866 - GLOWBOY (456 - 9269)**

To register your purchase www.dansons.com/support



**READ THIS ENTIRE MANUAL BEFORE YOU INSTALL AND USE YOUR HEATER.
FAILURE TO FOLLOW INSTRUCTIONS MAY RESULT IN PROPERTY DAMAGE,
BODILY INJURY OR EVEN DEATH!**



Installation shall conform to CAN/CSA B365 Installation Code for Solid-Fuel-Burning Appliances and Equipment in Canada and NFPA 211 Chimney, Fireplaces, Vents and Solid Fuel Burning Appliances in the USA.

Contact local building or fire officials about restrictions and installation inspection requirements in your area.

Dear **Glow Boy Multi-Fuel / Pellet Stove Owner:**

CONGRATULATIONS on the purchase of your **Glow Boy Multi-fuel pellet appliance!** You have selected the finest in residential wood pellet heating technology.

Let us pass on a few "tips" concerning installing your stove and heating with wood pellets.

1. Whether you install your stove yourself or hire a professional installer, **a quality installation is a must** for the safety of your family and for efficient, satisfactory operation of your stove.
2. **Initial Burn Setup of the stove** is the most important step to ensure the efficient and satisfactory operation of your appliance for many years to come. Pellet appliances ARE NOT plug 'n play.
3. **Know the quality and characteristics of the pellets or fuel you burn.** Pellets can vary greatly from company to company, from load to load and occasionally from bag to bag.
4. Be extra **diligent in your cleaning program.**
5. Remember that most operational dilemmas with a pellet stove are usually traced back to Improper installation, poor quality pellets and/or a lack of timely cleaning.

With just a minimum of daily care your **Glow Boy** pellet appliance will provide years of clean, efficient, comfortable and environmentally sound heating.

Thank you for selecting a **Glow Boy** multi-fuel pellet appliance.

Sincerely,



Canadian Comfort Industries &
Dansons Inc.

UPDATES and REGISTRATION

Up to date additions, product information, product registration and warranty extension registration can be found on our website www.dansons.com/support

COPYRIGHT NOTICE

Copyright 2009, Dansons Inc. All rights reserved.



No part of this manual may be copied, transmitted, transcribed, stored in a retrieval system, in any form or by any means without the expressed written permission of, Dansons Inc.; 14648 – 134th Ave., Edmonton, AB, Canada T5L 4T4

Friendly Reminder:

A pellet stove / insert is not designed or tested as a primary source of heat. They are designed to be a supplementary heat only, thus working together with your heating source.

Please do not disconnect or remove your existing primary heat source.



TABLE OF CONTENTS

GENERAL INFORMATION		MAINTENANCE	
SAFETY PRECAUTIONS	4	REQUIRED ROUTINE CLEANING	30
SAFETY TESTING	5	2 TO 3 DAYS OR WEEKLY	
HOW YOUR APPLIANCE WORKS	6	PERIODIC MAINTENANCE	31
AUTOMATIC SAFETY FEATURES	7	1 TON, SEASONAL, BI-SEASONAL	
SPECIFICATIONS	8	FALL START-UP	32
ELECTRICAL REQUIREMENTS		SPRING SHUT-DOWN	32
PRE PLANNING		YEARLY MAINTENANCE CONTRACTS	33
PLANNING & INSTALLATION CHECKLIST	9	TROUBLE SHOOTING	33
PLANNING EXHAUST SYSTEMS		REPLACEMENT PARTS	36
TYPE	10	HOPPER CLEAN-OUT CHUTE	37
SAFETY PRECAUTIONS		LIMITED WARRANTY	38
DETERMING SIZE & DISTANCE	11	SERVICE MAINTENANCE LOG	39
TERMINATION	12		
PLANNING OUTSIDE AIR	13		
APPLIANCE PLACEMENT	14		
FLOOR PROTECTION			
CLEARANCES TO COMBUSTIBLES			
INSTALLATION			
TOOLS OF THE TRADE	16		
STEP BY STEP DIRECT VENT INSTALLATION	17		
MOBILE HOME	18		
INSTALLATIONS OPTIONS	19		
OPERATION			
BEFORE LIGHTING YOUR FIRST FIRE	21		
USING THE ACUTRON CONTROLS	22		
CHOOSING YOUR MODE OF OPERATION	23		
MANUAL MODE			
THERMOSTAT MODES (OPTIONAL)	24		
UNDERSTANDING YOUR ACUTRON CONTROL	25		
LIGHTING YOUR FIRE	26		
PERFORMANCE ENHANCEMENT TIPS	27		
FUEL			
WOOD PELLETS	28		
CORN AND OTHER BIOMASS	29		

Simply
Better



Glow Boy

Shop & Home Heaters



We recommend that our pellet hearth products be installed and serviced by professionals who are certified in the U.S. by the National Fireplace Institute® (NFI) as NFI Pellet Specialists or who are certified in Canada by Wood Energy Technical Training (WETT). 

SAFETY PRECAUTIONS

IMPORTANT: Read, save and follow the instructions in this manual. It contains important safety, operating and maintenance instructions you will need.

RECOMMENDED: For your and your families protection and well being, Dansons' highly recommends installing and maintaining both a smoke detector as well as a CO2 detector.

- **BEFORE installing or having the pellet appliance installed contact the local building officials to obtain the necessary permits and information on any installation restrictions or inspection requirements in your area and notify your insurance company you have installed a pellet appliance.**
- This unit must be properly installed to prevent the possibility of a house fire. The instructions and local building codes requirements must be strictly adhered to. **Do not**; use makeshift methods or material that may compromise the installation.
- When the pellet appliance is installed in a mobile home, the heater must be bolted to the floor, have outside air, and **MUST NOT BE INSTALLED IN THE BEDROOM** in accordance with the Manufactured Home and Safety Standard (H.U.D), CFR 3280, Part 24. Check with local building officials.
- **NEVER** try to repair or replace any part of the heater unless instructions for consumer are given in this manual or instructed by Dansons Customer Service Department. A trained technician should do all other work.
- **Educate** all children of the danger of a high-temperature heater. Young children should be supervised when they are in the same room as the heater.
- This heater is designed and approved for **pelletized wood fuel, shelled corn, or wheat** only. Any other type of fuel burned in this heater will void the warranty and safety listing. Keep foreign objects out of the hopper.
- **NEVER** use gasoline, gasoline-type lantern fuel, kerosene, charcoal lighter fluid, or similar liquids to start or "freshen up" a fire in this appliance. Keep all such liquids well away from the appliance while it is in use.
- This heater must be connected to a standard 115 V., 60 Hz 3-prong grounded electrical outlet in accordance with local building codes, or in the absence of local codes, with the National Electrical Code, ANSI/NFPA 70.
A grounded surge-protection unit is recommended.
- **Do not** use an adapter plug or sever the grounding prong on the electrical plug.
- **Do not** route the electrical cord underneath, in front of, or over the heater.
- **Do not unplug the stove if you suspect a malfunction.**
Push the "OFF" Touch Pad and inspect the heater.
- The heater will not operate during a power outage. If a power outage does occur, check the heater for smoke spillage and open a window if any smoke spills into the room.
- **DO NOT** operate the heater if you smell smoke coming from the heater. Push the "OFF" Touch Pad, monitor your pellet appliance, and call your local authorized dealer.
- **Do not** place clothing or other flammable items on or near the heater. When installed with a thermostat there is a possibility of the heater turning on and igniting any items placed on or near the unit.
- **CAUTION:** To prevent fingers, clothing or other objects from coming in contact with the auger; your appliance is equipped with a shutoff switch which stops the auger when the hopper lid is open. **THE AUGER IS CAPABLE OF CAUSING SERIOUS INJURY AND THIS SWITCH MAY NOT BE DISCONNECTED.**

- **DO NOT** operate the stove if the flame becomes dark and sooty or if the firepot overfills with pellets. Push the **OFF** Touch Pad and inspect the heater. (See Operating Your Stove). Soot or creosote may accumulate in the exhaust vent system when the stove is operated under incorrect conditions such as an extremely rich burn. The flame will have a lazy orange color with black tips. This indicates poor pellet fuel combustion.
- **NEVER** block free airflow through the open vents of the unit. The viewing door and ash pan must be closed and latched during operation.
- The pellet appliance exhaust system works with **negative** combustion chamber pressure and a **positive** chimney pressure, therefore the exhaust system must be completely airtight and properly installed. All exhaust system vent joints must be sealed, gas tight, with HI-TEMP RTV silicone sealant, and/or at least 3 sheet metal screws **per joint and to the heater** also.
- Your heater requires periodic maintenance and cleaning (Refer to "Routine Cleaning" section of the manual). Failure to maintain your heater may lead to smoke spillage in your home.
- **Disconnect** the power cord from the electrical outlet before performing any maintenance. Pushing "OFF" Touch Pad does not disconnect all power to the heater.
- **BEFORE** carrying out any maintenance or cleaning, allow the heater to cool. Ashes must be disposed in a metal container with a tight lid and placed on a non-combustible surface or on the ground, well away from all combustible materials, pending final disposal.
- The exhaust system should be checked twice a year minimum for any build-up of soot or creosote. Do not touch the hot surfaces of the heater.

NOTE: Canadian Comfort Industries grants no warranty, implied or stated, for the installation or maintenance of your appliance, and assumes no responsibility of any consequential damage(s).



In accordance with the procedures and specifications listed in UL1482 – 1998 & ASTM E 1509-04, and ULC-S627-00 and ULC-S628-M93 for solid fuel room heater. Tested and listed for use in Manufactured Homes in accordance with Oregon Administrative Rules 814-23-900 through 814-23-909. The Canadian Comfort Industries pellet stove has been independently tested and listed by INTERTEK (an accredited testing laboratory) to UL, ULC and CSA standards. It is tested and listed for residential installation according to current national and local building codes as:

- A Freestanding Room Heater
- A Hearth Stove
- A Mobile Home Heater.

The Safety Listing Label is located on the rear inspection panel for model CCGB1 and CCGB2. Please read the label carefully. It contains important information about installation and operation of your pellet appliance.

Note that your STOVE'S serial number is located on the safety label. Your appliance serial Number is preceded by a "WH-" (example WH-00000). (see diagram)

Wornock Hersey LISTED FOR USE IN MANUFACTURED HOMES FOR USE IN MOBILE HOMES (COMMERCIAL MODELS) / LISTÉ POUR L'USAGE EN HABITATIONS MOBILES (MODÈLES COMMERCIAUX)

WH-

TESTÉ PAR UL 1482-1998, ASTM E 1509-04, ULC-S627-00, ULC-S628-M93, POUR L'INSTALLATION DANS LES HABITATIONS MANUFACTURIÈRES SELON LES RÈGLES ADMINISTRATIVES DE L'OREGON 814-23-900 À 814-23-909.

MINIMUM CLEARANCES TO COMBUSTIBLES / MINIMUM DE DÉGAGEMENTS À VOISIN LA COMBUSTIBLE

A. 1 IN./PO. (25.4 MM)	D. 18 IN./PO. (457.2 MM)
B. 2 IN./PO. (50.8 MM)	E. 6 IN./PO. (152.4 MM)
C. 1 IN./PO. (25.4 MM)	F. 2 IN./PO. (50.8 MM)

BUILT IN INSTALLATION: (REQUIRE ACH-302 OR ACH-301 BUILT IN KIT) SEE INSTALLATION MANUAL FOR DETAILS.

FRAMING OPENING: CLEARANCES: HEIGHT = 24" SIDE & REAR STAND-OFF TO FRAME = 0" WIDTH = 28" HOPPER TOP TO FRAMING = 4"

INSTALLER SELON ET UTILISER SOUS-ENTRETIEN D'INSTALLATION DE MANUFACTURIERS ET LES CONSIGNES D'UTILISATION. LES FONCTIONNEMENTS LOCALS ENTRE EN CONTACT AVEC MANÈGE OU PIÈCE AU BOUT DES RESTRICTIONS ET INSPECTION D'INSTALLATION DANS VOTRE ZONE.

AVERTIR MONTAGE PAS L'APPAREIL DANS UNE SALLE DE BAIN, POUR L'ÉCLAIRAGE ONY AVEC 1/4" (6.35 MM) 3/16" (4.76 MM) CARREMENT EN BOIS PRÉLUSÉ. L'UTILISATION EN L'UN BOUT CARREMENT PEUT ÊTRE DANGEREUSE ET CAUSER UN ÉTAT D'ÉCHAUFFEMENT.

INSTALLER SUR UN PROTECTEUR DE PLANCHER NON-COMBUSTIBLE ÉTENDANT SOUS L'APPAREIL ET LES 6 POUCHES (152.4 MILLIMÈTRES) AU DÉLÀ DE L'AVANT. MONTRE PAS L'ÉCLAIRAGE SOUS L'APPAREIL. INSTALLEZ ET UTILISEZ BIEN DANS UNE MACHONNÉE D'ACCROISSANCE DE COSE OU LAINE CHIMÉE.

NE RELEVEZ PAS CETTE UNITÉ À UNE CONDUITE DE CHIMÈNE DE CHIMÈNE SERVANT UN AUTRE APPAREIL.

CIRCUIT DE MISE À LA TERRE: UN CIRCUIT DE MISE À LA TERRE DE PL. DE TOUTE DOTE EN UTILISE, LES DÉGAGEMENTS AVEC L'ÉCLAIRAGE DE PL. SONT SELON LES INSTRUCTIONS OU CIRCUIT DE MISE À LA TERRE MANUFACTURIERS. VOIR LE STATUT LOCAL CODES ET LES INSTRUCTIONS D'APPAREIL ET D'ÉTENDRE MANUFACTURIERS POUR LES PRÉCAUTIONS REQUIÈRES POUR PASSER LE CIRCUIT DE MISE À LA TERRE PAR UN AIR OU UN PLANCHER COMBUSTIBLE. DANS CERTAINES CONDITIONS D'UTILISATION, L'ÉCHAUFFEMENT DE CIRCUIT PEUT SE PROCURER RAPIDEMENT. EXAMINEZ ET RETENEZ LE CIRCUIT DE MISE À LA TERRE PRÉCÉDEMMENT.

ATTENTION: L'UNITÉ ÉCLAIRÉ AVEC DES PORTES INTRÉVUES FERMÉES EMPÊCHENT LE VENTRE PAR LE VENTRE EN CHANGEMENT SÉLECTEMENT. ÉTENDRE, 120 VOLTS, 2,0 AMPÈRES 60 HERTZ. COSE D'ACCROISSANCE D'ÉCLAIRAGE LOCAL A PARTIR D'UNITÉ. INSTRUCTIONS DE L'ÉCLAIRAGE (BUT D'ÉCLAIRAGE) PLACES UN PIED DE GRANDES SUR LA GAUCHE. PLACES LE DÉMARRAGE DU PNEU DE PROPRIÉTAIRE SUR DES GRANDES - ATTENTION LE COMMANDEUR "CHAUFFAGE" EN MARCHE. LUMÈRE - À LA PORTE ÉCLAIRÉ, TOURNER LE COMMANDEUR DE "CHAUFFAGE" AU BAS POUR ÉCLAIRER, COMMANDEUR "CHAUFFAGE" EN MARCHE. NE TOUÇER POUR SE RAPPORTER HORS FONCTION AU MANUEL D'OPÉRATIONS, POUR LES DÉTAILS SUPPLÉMENTAIRES.

AVERTISSEMENT: LES PIÈCES MOBILES PEUVENT CAUSER DES DOMMAGES. NE FONCTIONNEZ PAS AVEC LE PANNÉAU OUVERT.

DANGER: RISQUE DE DÉCHARGE ÉLECTRIQUE. DÉBRANCHEZ LA PUISSANCE AVANT UNITÉ D'ENTRETIEN.

AVERTISSEMENT: LES PIÈCES CHAUDES NE FONCTIONNENT PAS AVEC LE PANNÉAU OUVERT.

FABRIQUÉ PAR: INDUSTRIES CANADIENNES DE CONFORT, ACHESON, AB, CANADA. VALÉZ À NE PAS ENLEVER NI À DISSIMULER CE COLLANT.

HOW YOUR APPLIANCE WORKS

The operations and maintenance of your **Glow Boy Series** of multi-fuel appliance are unique and should not be considered to be like a wood, coal, gas, electric, propane or oil heater, stove or appliance.

Cautions:



Do not try to operate your stove with viewing door open. Pellets will not feed under these circumstances and a safety concern may arise from sparks or fumes entering room.



If you are not drawing combustion air from outside, care must be taken to allow for adequate air make up, to avoid possible room air starvation when stove or other exhaust fans are in operation.



It is highly recommended that you install a high quality **smoke detector** as well as a **carbon monoxide gas** detector in the room where stove is installed. Care should be taken to make sure detectors are in working order at all times.

FUEL CONSIDERATIONS

Your **Glow Boy Series of Multi-fuel appliance** is designed to burn the following:

1. Wood pellets that comply with the Pellet Fuel Industries standards.
2. A combination of up to 50/50 Wood Pellet and Shelled Corn
3. 100% Shelled Corn or Grain, using the Multi—Fuel Grate, and manual start only, No Igniter.

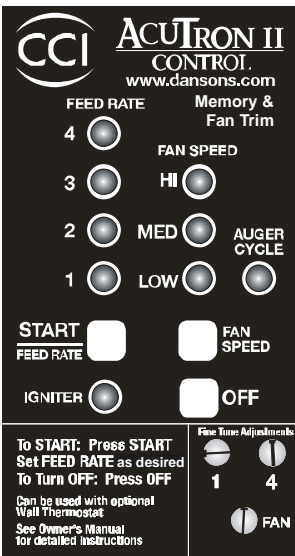

Fuel in the form of wood pellets, shelled corn or grain is stored in the hopper. An auger delivers the pellets to the burn grate. The fuel rate, or heat output, is set by adjusting the feed rate touch pad, (settings 1 to 4). A fan provides combustion air to the burn grate. The amount of combustion air in the burn grate is adjustable and automatically changes as the fuel rate changes. The higher the fuel rate, the larger the amount of combustion air and visa versa. The fuel burns in the burn grate, producing heat. Some heat radiates out the front of your stove. The majority of the heat passes around the heat exchange tubes and air plenum around the firebox and is then moved into the room by the room air fan. A small amount of heat must pass out the exhaust of your stove, along with gases, into the atmosphere.

Your stove's heat output can be adjusted from setting 1-4, through the FEED RATE touch pad, to vary your heat output from Low to High.

The room air fan can be manually adjusted through the FAN SPEED to run faster or slower to correspond to the amount of

heat being produced. The room air fan is also on a limit switch, controlled to run on high when the stove reaches higher temperatures and then resume the speed you had selected once it cools to a lower temperature.

Your stove can run efficiently over extended periods of time and at different heat output levels as long as the fuel supply is uninterrupted and **timely cleaning and maintenance is preformed**. An example of how improper cleaning effects operations is; the exhaust pressure switch will shut the pellet supply off and your stove will shut off if the exhaust system becomes plugged.

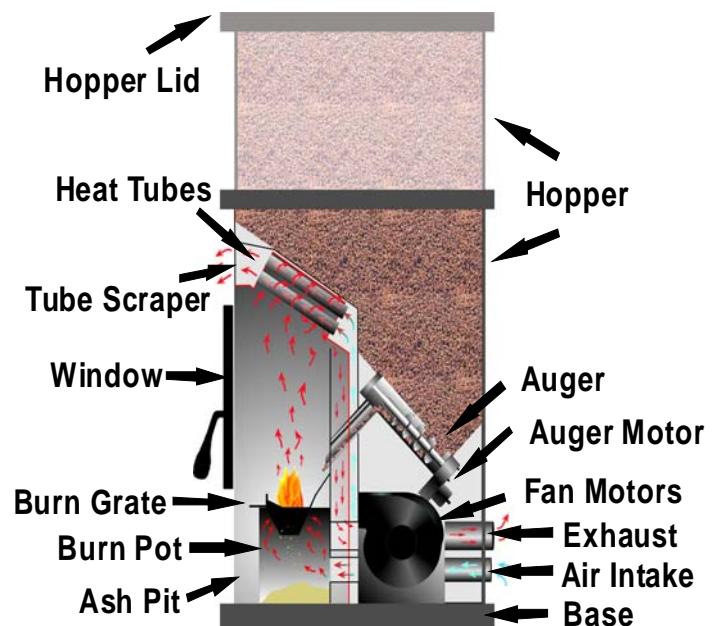

AUTOMATIC SAFETY FEATURES

L120 LOW LIMIT SWITCH

This limit switch is mounted on the exhaust blower housing and has 2 main functions:

Should the fire happen to go out, for any reason, this limit switch will shut the stove off when the exhaust temperature drops below 120° F.

Upon starting the appliance, the AcuTron control board has a 15 minute "Lighting Mode", if the stove exhaust does not reach 120° F in that 15 minutes the stove will shut off. As soon as the stove exhaust does reach 120° F, the limit switch opens and the AcuTron enters a 5 minute "Safety Delay" mode.

F140 FAN LIMIT SWITCH

Your pellet appliance has a convection fan control limit switch. The room air fan's (F140) temperature limit snap switch automatically operates the fan on high when your stove is producing heat faster than the fan is carrying it into the room. This may occur when the heat control lever is set at [3 or 4] and the **FAN SPEED** is set to a very low or off setting. After the fan runs at this automatic high setting a few minutes, it may cycle back to its lower setting and may continue to cycle between [HIGH] and your selected setting. The circulation (room air) fan cycling from high to low is a normal condition as well as a safety feature of your appliance. To compensate for the fan cycling, adjust the FAN SPEED to a higher setting.

L250 HIGH LIMIT SWITCH

Your pellet appliance has a high temperature limit switch installed. If the temperature at the back of the firebox reaches approximately 250° F., the switch will shut off the electricity going to the Vacuum Switch and to the Auger Motor. The auger will automatically stop, and the appliance will shut down when the exhaust temperature cools (120° F). If this happens call your dealer or Dansons Customer Service (1-866-456-9269).

IT IS IMPORTANT TO FIND THE REASON WHY THE UNIT OVERHEATED.

VACUUM SWITCH

This safety device (mounted on the back panel pillar) detects vacuum in the exhaust system, firebox, and air intake. If the exhaust blower fails, the vent pipe becomes plugged, the viewing door is open, or if you are out of pellets, this switch will sense that there is a lack of vacuum and will stop the auger from continuing to feed pellets.

HOPPER LID SWITCH

This device is mounted inside the hopper and is connected to the auger feed system.....

If the hopper lid is **OPEN** the switch **WILL STOP THE AUGER FEED SYSTEM**. This is to prevent fingers, clothing or other objects from coming in contact with the auger.

The auger is capable of causing serious injury and this switch MAY NOT be disconnected.

Left Hand Side View
/ Exhaust Fan Side

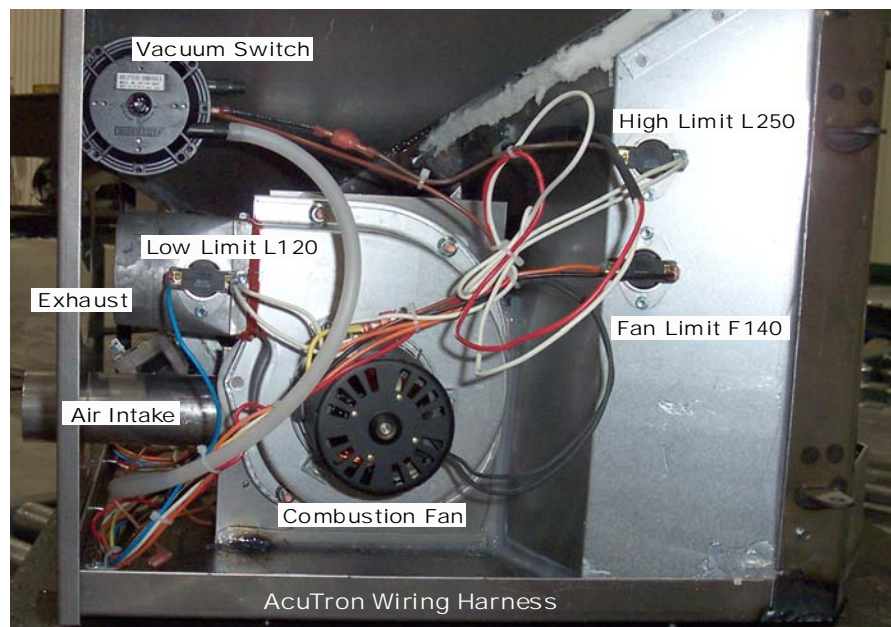

If the power does go out, the pellet appliance will stop running. When the power comes back on, the stove will remember the function it was performing and return to that function.

SPECIFICATIONS

HEATING SPECIFICATIONS

Approx. Heating capacity (sq. feet) *	800 – 2,000		
Approx. Fuel burn rate per hour **	1.5 – 5 lbs		
Hopper Capacity - Home 120	120 lbs	Approx. Burn time at lowest setting	90 hrs
Hopper Capacity – Home 300	300 lbs.	Approx. Burn time at lowest setting	200 hrs

1 Heating capacity will vary depending on floor plan layout of your home, degree of insulation, and the outside temperature. Fuel size, quality, density and moisture level will also have an effect.

11 Pellet size may affect the actual rate of fuel feed and burn times. Fuel feed rates may vary by as much as 20%. Use PFI listed fuel for best results.

DIMENSIONS

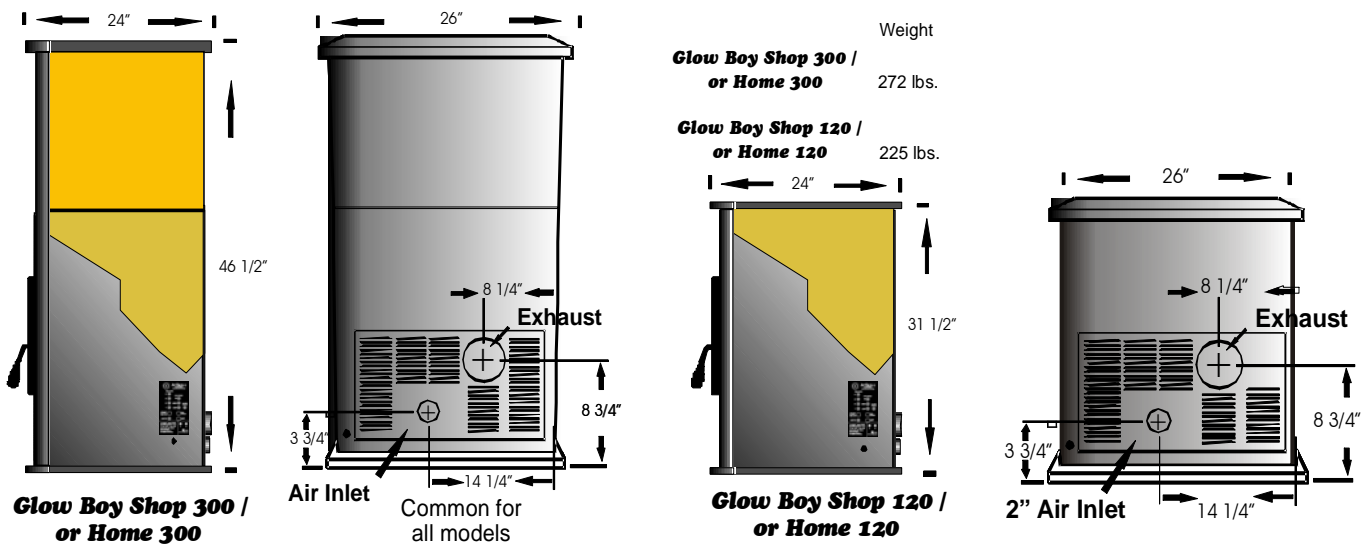

ELECTRICAL SPECIFICATIONS

Electrical Rating	= 115 Volts 60 HZ 2.0 Amps
Watts (operational)	= 175 (approximately)
Watts (optional igniter)	= 475 (approximately)

A voltage surge protector or ground fault outlet is required for this unit. The warranty on the circuit board will be voided if surge protection is not installed before operating this unit.

If power outages or disturbances are a concern, you may wish to purchase a gas powered generator, solar or battery back-up system. Ensure that it is a "Positive" sign wave and a minimum 1000 watts continual.

EPA COMPLIANCE

This heater is exempt from EPA Phase II requirements, but has been tested for emissions using EPA test methods by Warnock Hersey, US. Pellet appliances that are designed with the combustion air supply exceeding 35:1 (by ratio) are exempt from EPA regulations.

PRODUCT IS SUBJECT TO CHANGE WITHOUT NOTICE.

PLANNING & INSTALLATION CHECK LIST

Unless you are knowledgeable and experienced in stove installation, we recommend your Glow Boy Appliance receive a Pre-delivery Check and be installed by your local Specialty Retailer, NFI (National Fireplace Institute) Pellet Specialist (USA) or WETT Certified Installer (CAN) .

COMPLETE THIS CHECK LIST PRIOR TO INSTALLING YOUR MULTI-FUEL APPLIANCE:

- _____ Carefully read this "Owners Manual". **SAVE THIS MANUAL.**
- _____ Have your local Dealer **demonstrate all the operational, cleaning and maintenance steps necessary for your stove.**
- _____ **Select a location.** The design of your home and the stove placement will determine its value as a source of heat. A pellet appliance depends primarily on air circulation to disperse its heat. There are other practical considerations, which must be considered before a final placement is decided on:
Existing Chimneys, Pellet Fuel Storage, Aesthetic Considerations, Roof Design (rafter locations & roof pitch), Room Traffic, Clearances to Combustibles, and Existing Wiring.
- _____ The installation of this appliance **must conform to local codes and applicable state and federal requirements.** Becoming familiar with these requirements **before** installation is essential.
- _____ Sign and keep a copy of the **Pre-delivery Check List supplied by your Authorized Dealer, OR "Dansons Certified Installer", found inside our appliance or available online.**
- _____ **Attach your proof of purchase to this manual and keep on hand for warranty.**

COMPLETE THIS CHECK LIST WHILE INSTALLING YOUR MULT—FUEL APPLIANCE:

- _____ Carefully read the **ENTIRE** installation section first. Twice is better.
- _____ Read the Installing Freestanding, Insert or Built-In sections.
- _____ **Determine** the location and measurement needed your chosen location.
- _____ **Be sure to pre-fit** all items before you install, fasten or install the stove permanently.
Remember measure twice, cut once.
- _____ **Ensure ALL** joints of "PL" vent and single wall stainless steel liner are tightly connected, **sealed with RTV Silicone or Hi-Temp foil tape, including to the exhaust connector,** and is correctly installed. (Follow vent manufacturer's instructions.)

COMPLETE THIS CHECK LIST PRIOR TO LIGHTING YOUR FIRST FIRE:

- _____ **Obtain final inspection** and approval by local building officials.
- _____ Carefully **clean all marks off the brass, nickel or pewter parts** before the first fire is lit. Use a soft cloth and a gentle type cleaner. **Caution:** Never use an abrasive cleaner on any part of your stove.
- _____ **Polish the hopper** to remove the oil type coating used in manufacturing.
- _____ The high temp. stove paint used on your stove may take several hours of burning at a high fuel setting to fully cure. During this time an odor, which is not harmful, may be evident. The area around the stove should be well ventilated.
- _____ Review and follow the **Lighting and Controls Instructions.**
- _____ **Ensure that appliance is connected to a surge protection unit.**
- _____ **Fill the hopper with quality pellets, Close the Hopper Lid,** Using the CCI "AcuTron", (figure 5), PUSH the **FEED RATE** Touch Pad and this will start the auger and the combustion fan.

PLANNING—EXHAUST SYSTEMS

PELLET VENT MUST MAINTAIN A MINIMUM 3" CLEARANCE TO ANY COMBUSTIBLE (INSTALL VENT AT CLEARANCES SPECIFIED BY THE VENT MANUFACTURER).

DO NOT CONNECT THE PELLET VENT TO A VENT SERVING ANY OTHER APPLIANCE OR STOVE.

DO NOT INSTALL A FLUE DAMPER IN THE EXHAUST VENTING SYSTEM OF THIS UNIT.

PELLET VENT TYPE:

1. Must be an approved 3" or 4" Diameter Type "PL" vent, vented to the outside (fig. 7) or connect the vent to a factory built type "A" chimney using an adaptor.
2. Exception: A single wall "All Fuel" Stainless Steel chimney liner may be used inside a fireplace or fireplace installations (fig. 8) .
3. Some venting manufactures do make "PL" vent for use with wood pellet fuel only and another type of "PL" vent for corn or bio mass fuels. If in doubt, plan for the future and use the corn or multi-fuel

VENT SAFETY PRECAUTIONS:

- ☯ A "Clean Out Tee" (4) must be installed at the bottom of all vertical runs. These "Tee's" are to assist in periodically cleaning the vent. Single or Double clean out tees may be used. The exhaust system must be installed so the entire system can be cleaned without disassembly.
- ☯ Termination must exhaust above the fresh air inlet elevation, and parallel or above the exhaust output of the multi-fuel appliance.
- ☯ It is highly recommended that at least 3 feet of vertical pipe (5) be installed to create some natural draft. This is to help prevent the possibility of smoke or odor during the appliance shut down.
- ☯ Horizontal sections must have a 1/4" rise every 12" of travel after 3' long.
- ☯ Pellet vent connections must be sealed gas tight. Use Hi-Temp RTV Silicone, good for over 600° F or Hi-temp Metal foil tape, that meets UL181 standards,. DO NOT use "Duct Tape".
- ☯ Seal each vent section by injecting a liberal amount of sealant into the gap and/or wrap with foil tape.
- ☯ It is strongly recommended that the exhaust system be terminated on the prevailing wind side of the home.
- ☯ Appliance may not be placed in, or vented through a gas fireplace.

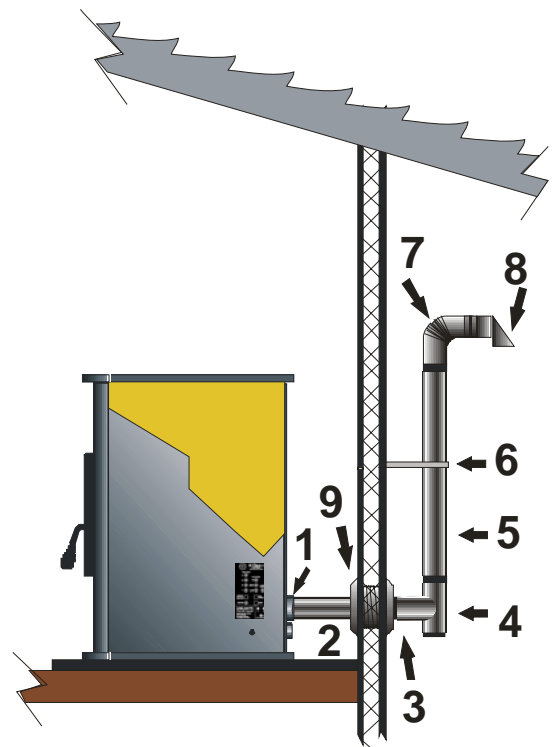

PLANNING— EXHAUST SYSTEMS ... CONTINUED

DETERMINE VENTING SIZE AND DISTANCE:

It is recommended that the vent system be installed with a minimum of three (3') of vertical rise above the appliance exhaust port.

Equivalent Vent Length (EVL) is the method of determining vent sizes and lengths, that takes into account the effect of different component parts on air flow.

STEP 1 To help you determine the correct size and/or run, simply fill in the chart below.

Pellet Venting Component	# of Elbows OR feet of Pipe	Multiply by	Equivalent Feet	Component Equivalent
90 Degree or Tee		X	5	
45 Degree		X	3	
Horizontal Pipe		X	1	
Vertical Pipe		X	.5	
			Total Equivalent	

Step 2 Ensure the Total Equivalent is or is less than 30.

Step 3 Use the Sizing Chart to determine the proper venting size according to the Total Equivalent and the Altitude above sea level.

NOTE: In some cases it may be necessary to contact Dansons Customer Service personal to determine acceptable venting configurations and altitude adjustments **1-877-303-3134**.

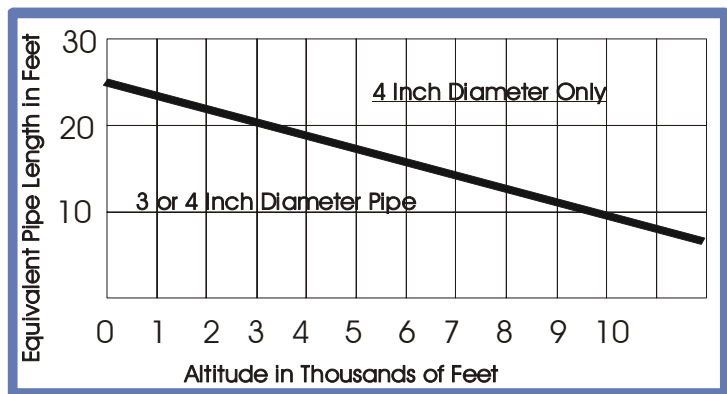

The diagram to the right will help to give you a visual reference.

Maximum venting height is 33'.
 Maximum horizontal offset is 10'.
 Use the Equivalent Vent Length Chart to determine proper combination of component parts.

Vent must have a support bracket every 5' when on the exterior wall.



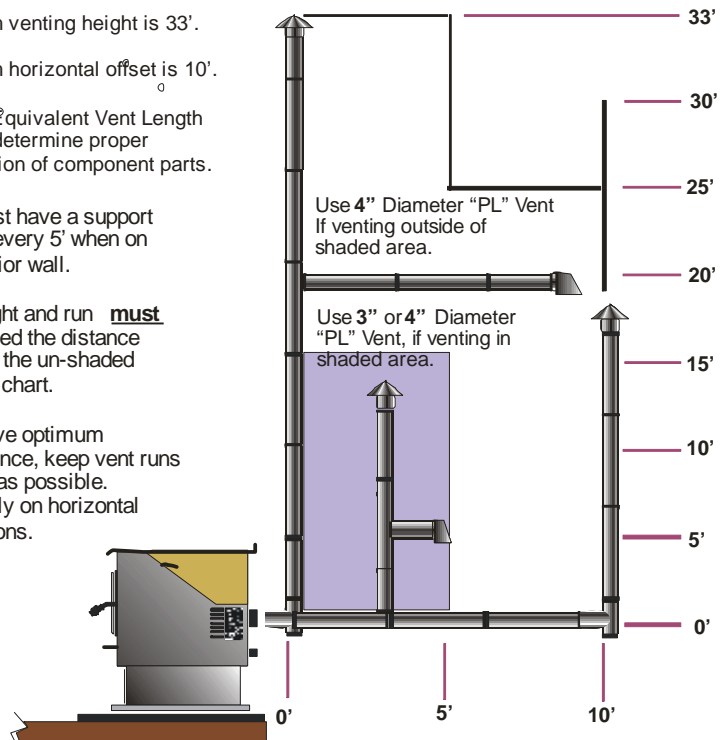

Vent height and run **must not** exceed the distance shown in the un-shaded region of chart.

To achieve optimum performance, keep vent runs as short as possible. Especially on horizontal installations.



PLANNING— EXHAUST SYSTEMS ... CONTINUED

PELLET VENT TERMINATION: (Figures 7 & 8)

-  Termination must be a minimum of 12" above the chase cap (B) (note: the chimney must meet local codes for height above the roof or other obstructions)
-  Must have an approved cap (G) (to prevent water from entering) or a 45° elbow downturn (F)
-  If the termination is located on a windy side of house, an approved house shield is recommended to prevent soot from accumulating on the side of the house.
-  Must not be located where snow or other materials such as leaves, snow or grass, could block it.
-  Must have a "Metal Seal Plate" or "Wall Thimble" at point (A)

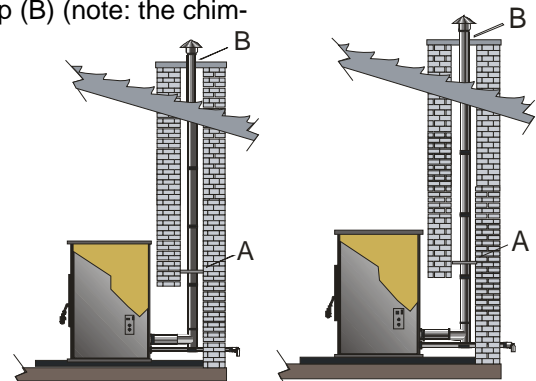
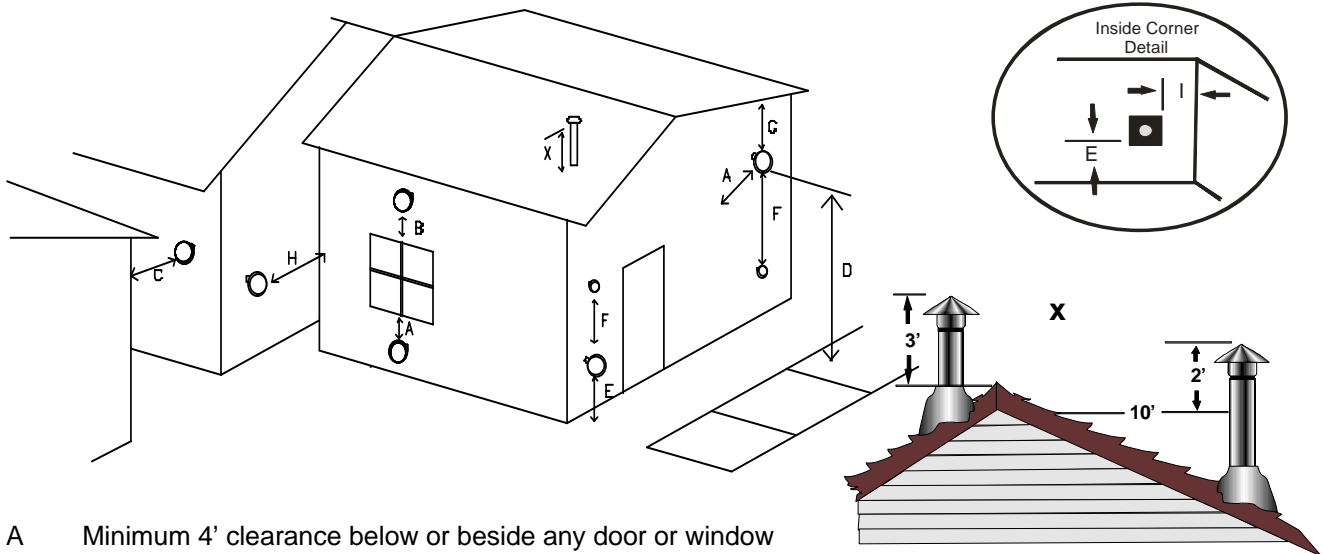

Figure 7

Figure 8

VENT TERMINATION CLEARANCES:

NOTE: Horizontal terminations must protrude 12" from the wall, vertical terminations 24"









- A Minimum 4' clearance below or beside any door or window which opens.
- B Minimum 1' clearance above any door or window that opens.
- C Minimum 3' clearance from any adjacent building.
- D Minimum 7' clearance above any grade when adjacent to public walkways.
- E Minimum 2' clearance above any grass, plants, or other combustible material.
Minimum 1' clearance above grade.
- F Minimum 3' clearance above any forced air intake of any other appliance within 6'.
- G Minimum 2' clearance below eaves or overhang.
- H Minimum 1' clearance horizontally from combustible wall.
- I Minimum 1' clearance to inside corner
- X Must be a minimum of 36" above the roof and 24" above the highest point of the roof within 10'.

NOTE: The following are not found on the above diagram.

- Minimum 3' above a gas meter/regulator within 3' horizontally of the vertical centre line of regulator.
- Minimum 6' clearance to a gas service regulator vent outlet.
- Minimum 1' clearance under veranda, porch, deck or balcony. Permitted only if structure is fully open on a minimum of two sides beneath the floor.

PLANNING— OUTSIDE AIR

-  Outside air is **REQUIRED ON ALL MOBILE HOME INSTALLATIONS.**
-  Outside air is strongly recommended for all other installations. Failure to install intake air may result in improper combustion as well as the unit smoking during power failures.
-  Metal pipe, **ONLY**, either solid or flexible, must be used in all outside air installations. (B)
NOTE: Non-metallic material, such as PVC or ABS plastic, MUST NOT BE USED for outside air installations.
-  A wind shield, (C), over the termination of the outside air pipe or a 90 degree elbow or bend directed away from the prevailing winds **MUST** be used when an outside air pipe is in-stalled through the side of a building. Keep the outside air pipe termination at least 1 foot away from the exhaust system termination.
-  When outside air is taken from an existing chimney, the exhaust system must not terminate in the same chimney.
-  The outside air pipe on your stove is 2" OD. The outside air connecting pipe must be at least 2" ID The outside air connecting pipe must be as short and free of elbows as possible, and **must fit over**, (A), not inside, the outside air pipe on your stove.
-  For distances over 10' long, 3" or 4" OD pipe is recommended, then reduce to 2".

Through The Wall Kits Include:

3 FOOT PACKAGE – PART# 5150-1450

- 1 – 2" Galvanized Hood c/w screen
- 1 – 2" Aluminum Flex Duct – compressed 15" length, extends to 30" – 36"
- 2 – 2" Worm Gear Clamps

10 FOOT PACKAGE – PART# KS5150-1460

- 1 – 2" Galvanized Hood c/w screen
- 1 – 2" Aluminum Flex Duct – compressed 4' length, extends to 120"
- 2 – 2" Worm Gear Clamps



NOTE: Available from your local Authorized Dealer or Dansons Inc.
1-877-303-3134

Figure 11

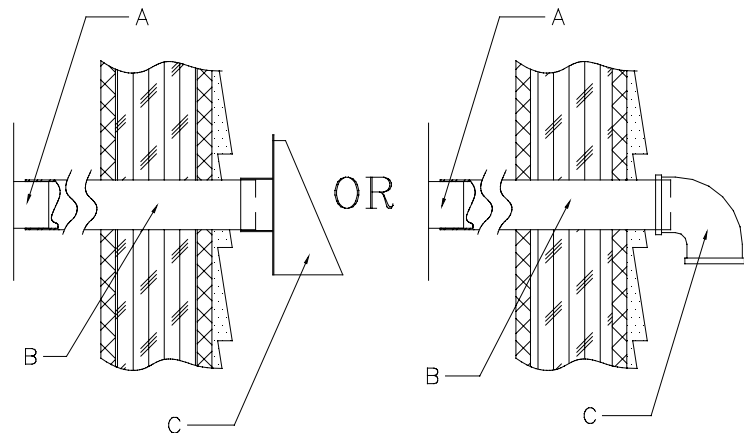

PLANNING— PROTECTION & CLEARANCES

STOVE PLACEMENT:



Stove must be placed so that no combustibles are within, or can swing within (i.e. drapes doors), 36" of the heater.



Keep in mind the following placement concerns; venting obstructions, outside air, electrical outlet, wall thermostat, heat distribution, traffic patterns and room use/size.



If the stove is placed in a location where the ceiling height is less than 7', it must follow the requirements in the section "Alcove Installation".

FLOOR PROTECTION REQUIREMENTS:



Stove and floor protection must be installed on a level secure floor

NOTE: It is important for your appliance to be level. Leveling should occur below the floor protection pad.



The stove must be installed on a continuous (grouted joints) non-combustible floor protector such as ceramic tile, cement board, brick, 3/8" millboard or equivalent, or other approved or listed material suited for floor protection.



THE MATERIAL(S) USED MUST HAVE, OR COMBINE TO HAVE, A MINIMUM INSULATIVE RATING OF "R1".



Must extend 6in (300mm) beyond the front of the stove as well as 6 in (300mm) beyond each side of the fuel loading and ash removal opening(s)
Must extend under and 2" to each side of chimney tee (if used).

MINIMUM CLEARANCES TO COMBUSTIBLES: Figure 10—15

2" From Back Of Stove to Combustibles

3" From PL Vent to Combustibles

10" From Front Side of Stove to Combustibles

2" From Back Corner of Stove to Combustibles

6" Non Combustible Surface In Front Of Heater

16" From Top Of Stove to Combustibles

36" to drapes, doors, anything that can swing

NOTE: Although not required for safety reasons, it is strongly suggested that sufficient space be provided (a minimum of 24") on each side of the appliance and at the back of the appliance to enable servicing the unit if necessary. If this space is unavailable, a provision must be made to enable sliding the appliance out.

CLEARANCES – "STRAIGHT INSTALLATION":

THROUGH THE WALL

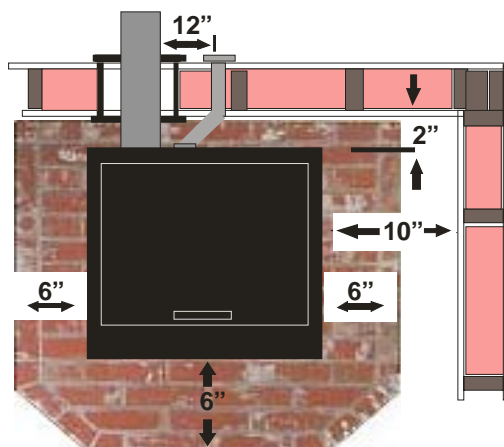

INTERIOR VERTICAL

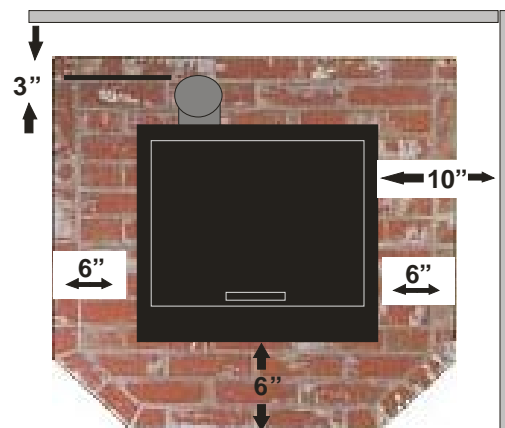

PLANNING— PROTECTION & CLEARANCES ... CON'T

CLEARANCES – “CORNER INSTALLATION”:

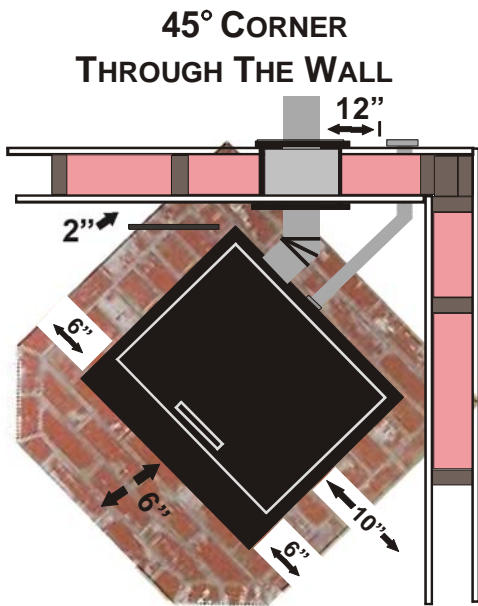

Figure 12

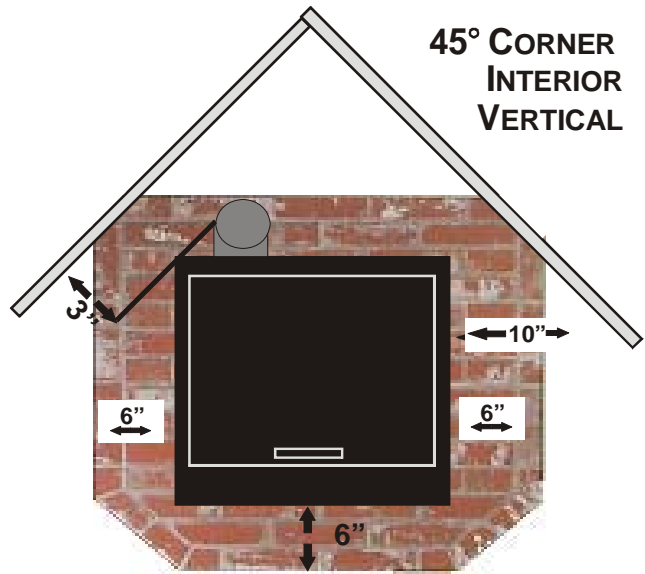

Figure 13

Note: If interior vertical vent is used (figure 13), the clearance to the back wall is determined by the upward-turned “Clean Out Tee”. It will vary in depth depending on the brand of PL vent used. Before placing the stove, connect the “Tee” and measure off the 3” clearance.

ALCOVE INSTALLATION:

Minimum clearances to combustibles: (Figure 14 & 15)
 2 inch from back of appliance 10 inches from the sides
 16 inches from the top 30 inches deep

ALCOVE - THROUGH THE WALL

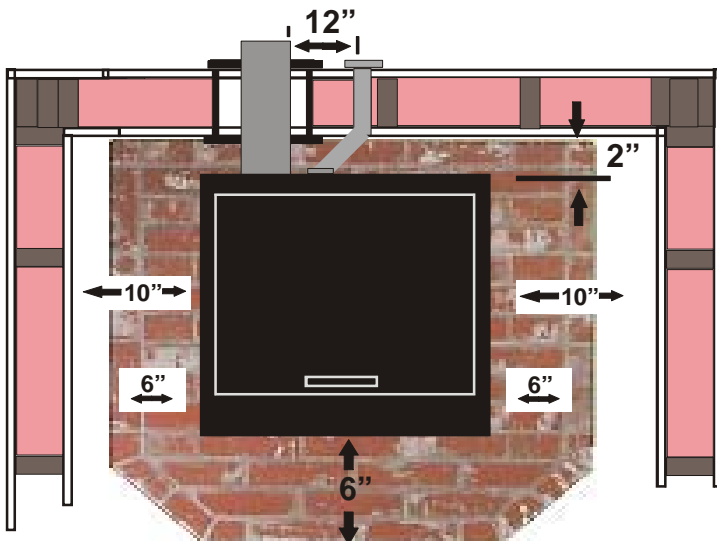

Figure 14

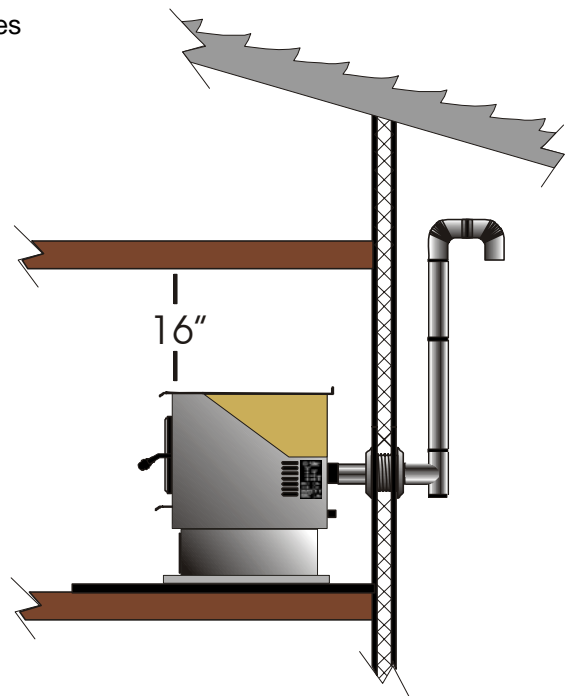

Figure 15

TOOLS REQUIRED

Before starting your Glow Boy Multi-Fuel install, we recommended you have the following list of tools ready. This is not an exhaustive list, but should go along way in making your installation easier.

Power Tools

- Shop Vacuum WITH Filter
- Jigsaw or Reciprocating saw
- Electric drill
- Extension cord
- 4" or 5" diameter coring bit and drill
(if going through concrete)

Hand Tools

- Tape Measure
- Caulking Gun
- Circle Maker
- Allen (Key) wrench set
- Stud Finder
- Set of sockets or nut driver 1/4", 5/16" and 7/16"
- Assortment of Phillip, Robertson and slot screwdrivers
- Assortment of sheet and wood drill bits
- Flashlight
- Wire stripper and wire cutter
- Hammer
- Bubble Level
- Utility knife
- Adjustable pliers (6 to 8 inches)
- Small hand broom and dustpan
- Furniture and Floor Protection

Supplies

- Caulking tube of RTV Hi-Heat Silicone
- Caulking tube of Clear Silicone
- Hi-Heat Aluminum Foil Tape
- 2" long Wood screws (10+)
- Assortment of sheet and wood screws
- "Stove Bright" Hi-Heat Stove Paint

INSTALLATION—FREESTANDING

THROUGH THE WALL, DIRECT VENT INSTALLATION. (not preferred) (Figure 18)

1. Select the location for your stove, design the exhaust system and determine the brand and size of "PL" vent to be used.
2. Position the floor pad.
3. Following the "PL" vent manufacturer's specifications, mark and cut a hole through the wall to accommodate the wall thimble, (F), and the outside air pipe, (I), if outside air is to be used. Remember that the outside air intake must be located no closer than 12" from the vent exhaust. Try to avoid cutting wall studs, and use extreme caution to avoid cutting into power or water lines within the wall of your home.
4. Install the wall thimble, (F). Be sure to run a bead of silicone around the outside edges of the wall thimble to reduce drafts, both inside and outside. Insert the proper size of "PL" vent, (E), through the wall thimble, (F).

THROUGH THE WALL

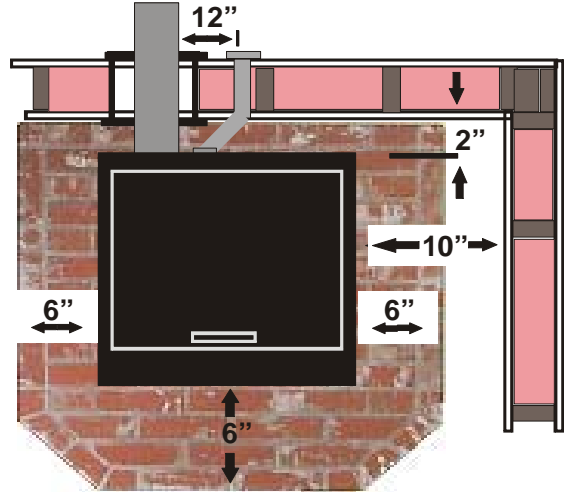

5. Place your stove on the floor pad, close to its final position. Leave room to connect the "PL" vent to "Quick Connect" end collar. If not already factory installed, Install the gasket (B) and "Quick Connect" exhaust end (C) to your stove to the "Quick Connect" mounting plate. Use the 4 x 7/16" nuts, supplied and secure tightly.
6. Place a bead of RTV silicone around the end collar of the "Quick Connect" of your stove's exhaust, (C). Firmly push the "PL" vent pipe adaptor (J) into the bead of RTV silicone.
Note: If 4" PL vent is required, use an 3" to 4" Pipe Adaptor Increaser, (J), on the stove exhaust pipe.
7. Connect the length of "PL" vent, (E), that is in the thimble, (F), onto the pipe adaptor (D). Fasten together with at least three sheet metal screws (approx. 3/8" in length). Place a bead of RTV silicone around the connection.
8. Place your stove in its final position on the pad. Place another bead of RTV silicone around the "PL" vent (E) and the inside of the wall thimble, to stop cold air drafts.
9. On the outside of the building, place an exhaust cap (G) or a 45 degree "PL" type elbow, (G), onto the end of the horizontal "PL" vent, (E). Optionally, place a rodent screen cap, (G), (may be required in some locals), on the end of the elbow, (G). run a bead of RTV silicone around all connections and around the "PL" vent pipe and the outside of the wall thimble.
Note: The end of the exhaust pipe must extend a minimum of 12" from the outside of the building.

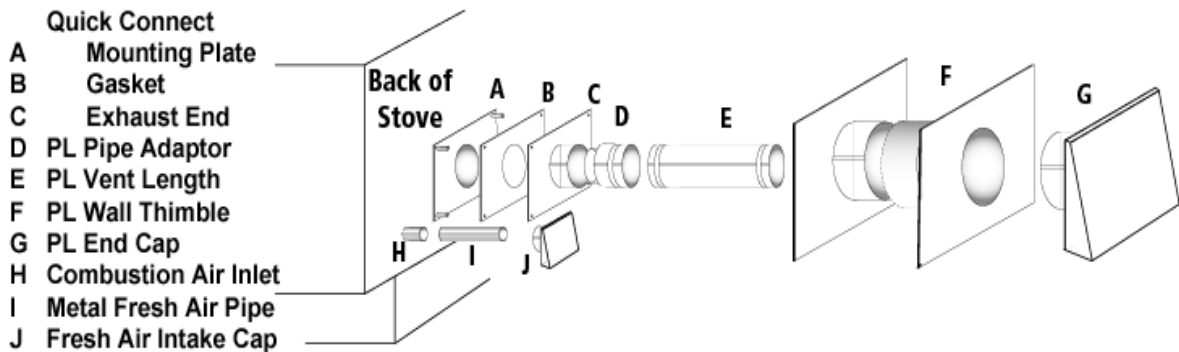





Note: Most horizontal, through the wall installations may require a Clean-out Tee and minimum 3' vertical rise of pipe, inside or outside the building. See Next Page.

MOBILE HOME INSTALLATION

**CAUTION: DO NOT INSTALL STOVE IN SLEEPING ROOM
THE STRUCTURAL INTEGRITY OF THE MANUFACTURED HOME FLOOR,
CEILING and ROOF MUST BE MAINTAINED!**

Your **Glow Boy** appliance has been tested and listed for mobile home installation. It may be installed in a mobile home as a "Free Standing Stove" or a "Hearth Stove", see detailed install and clearance requirements in these sections as they imply there.

In addition to all previously detailed installation requirements, mobile home in-stallations must meet the following requirements in accordance with the Manufactured Home and Safety Standard (HUD) CFR 3280, Part 24:

-  Permanently bolt your stove to the floor, (A), figure 25.
-  Electrically ground your stove or the pedestal to the steel frame of the home. Use a number 8 gauge copper wire, (B), figure 25, or equivalent.
-  The stove must have a permanent outside air source with a ¼ inch screen over the inlet. Figure 26, (B, C & D)
-  For transportation all chimney/vent above the mobile home must be removed.
-  Chimney/PL Vent must be 3" or 4" PL Vent and must extend a minimum of 36" above the roofline of the mobile home and must be installed using a UL / ULC listed ceiling fire stop (J), figure 26, and rain cap (L), figure 26., when installing as a vertical run. See diagram below.

**REFER TO THE VENTING DIAGRAMS IN THIS MANUAL FOR FURTHER EXHAUST CONFIGURATIONS.
INSTALL VENT AT CLEARANCES SPECIFIED BY THE VENT MANUFACTURER.**

A	Floor Pad
B	Combustion Air Intake
C	Fresh Air Duct
D	Fresh Air Hood
E	Stove Exhaust
F	Pipe Adapter
G	Clean Out Tee
H	Tee Support Bracket
I	Pipe
J	Firestop Spacer / Ceiling Support
K	Roof Flashing / Storm Collar
L	Rain Cap

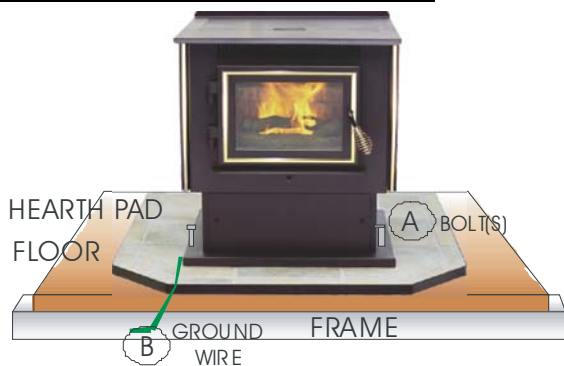

Figure 25

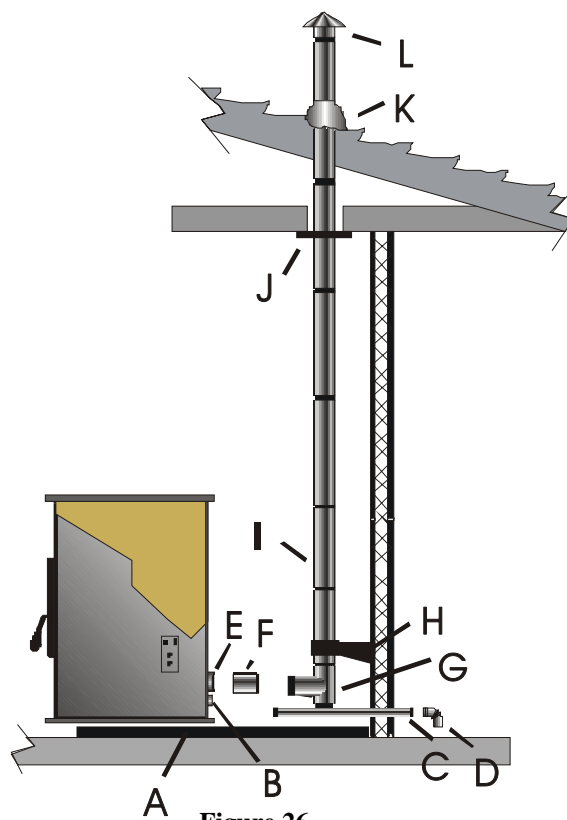

Figure 26

Note: When moving your mobile home, all exterior venting must be removed. Upon completion of relocation, all venting must be reinstalled, gas tight, and securely fastened.

FREESTANDING INSTALLATION ... CON'T

These styles of installation are highly recommended, due to possible backpressure in the exhaust caused by airflow around the outside of the structure, snow build-up, or power failure, etc.. These designs will improve venting performance and provide natural draft to help evacuate smoke from the appliance in case of power failure.

Follow the same basic steps in locating your appliance, attaching the exhaust system and outside air intake to your stove as the previous examples.

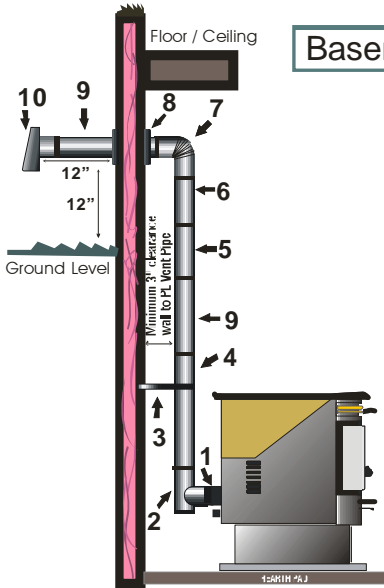

Basement or Main Floor

- 1 Pipe Adapter
 - 2 Clean Out Tee & Cap
 - 3 Tee Support Bracket
 - 4 36" Pipe Length
 - 5 12" Pipe Length
 - 6 12" Adjustable Pipe Length
 - 7 90 Deg Elbow
 - 8 Wall Thimble
 - 9 24" Pipe Length x 2
 - 10 Horizontal Rain Cap
- Tube of RTV Silicone
Roll of Foil Tape
3/8" Stainless Self-Tapping Screws x 27
2" Wood Screws x 10

Walkout Basement or Main Floor

- 1 Pipe Adapter
 - 2 12" Pipe Length
 - 3 12" Adjustable Pipe Length
 - 4 Clean Out Tee & Cap
 - 5 36" Pipe Length
 - 6 Tee Support Bracket
 - 7 90 Deg Elbow
 - 8 Horizontal Rain Cap
 - 9 Wall Thimble
- Tube of RTV Silicone
Roll of Foil Tape
3/8" Stainless Self-Tapping Screws x 21
2" Wood Screws x 10
- Options

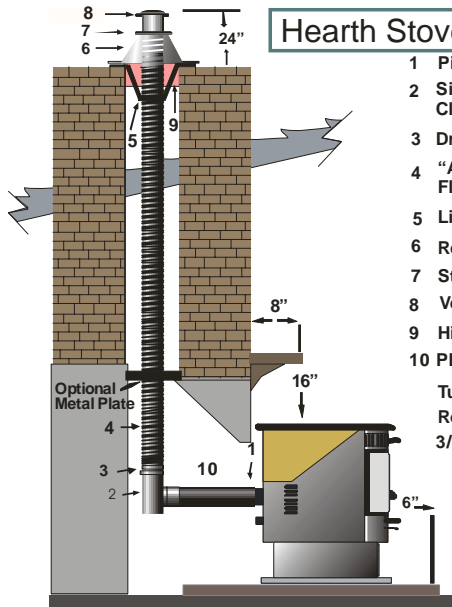
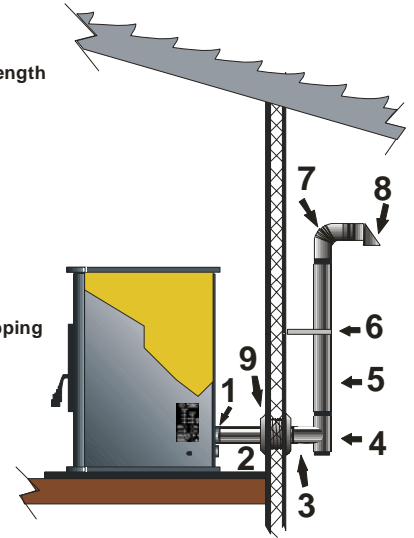

Hearth Stove - Existing Reline

- 1 Pipe Adapter
 - 2 Single Wall Stainless Steel Clean Out Tee & Cap
 - 3 Dripless Connection
 - 4 "All Fuel" Stainless Steel Flex Liner
 - 5 Liner Support
 - 6 Roof Flashing
 - 7 Storm Collar
 - 8 Vertical Rain Cap
 - 9 Hi Heat Insulation
 - 10 PL Vent Length
- Tube of RTV Silicone
Roll of Foil Tape
3/8" Stainless Self-Tapping Screws x 27

Outside Air may be obtained from a suitable duct passing through the ash clean-out opening.

Ensure the chimney top is properly sealed to prevent intrusion of weather and down drafts with suitable flashings, collars, and sealants.

Main Floor - Vertical

- 1 Pipe Adapter
 - 2 Clean Out Tee & Cap
 - 3 3 x 60" (15') Pipe Length
 - 4 Tee Support Bracket
 - 5 Ceiling Support / Firestop Spacer
 - 6 Roof Flashing
 - 7 Storm Collar
 - 8 Vertical Rain Cap
- Tube of RTV Silicone
Roll of Foil Tape
3/8" Stainless Self-Tapping Screws x 27
2" Wood Screws x 10

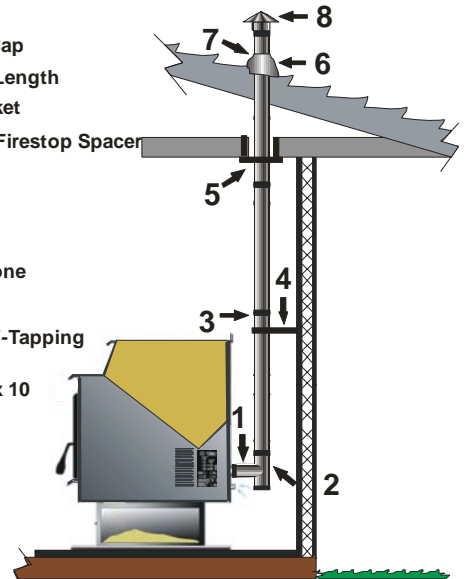

FREESTANDING INSTALLATION ... CON'T

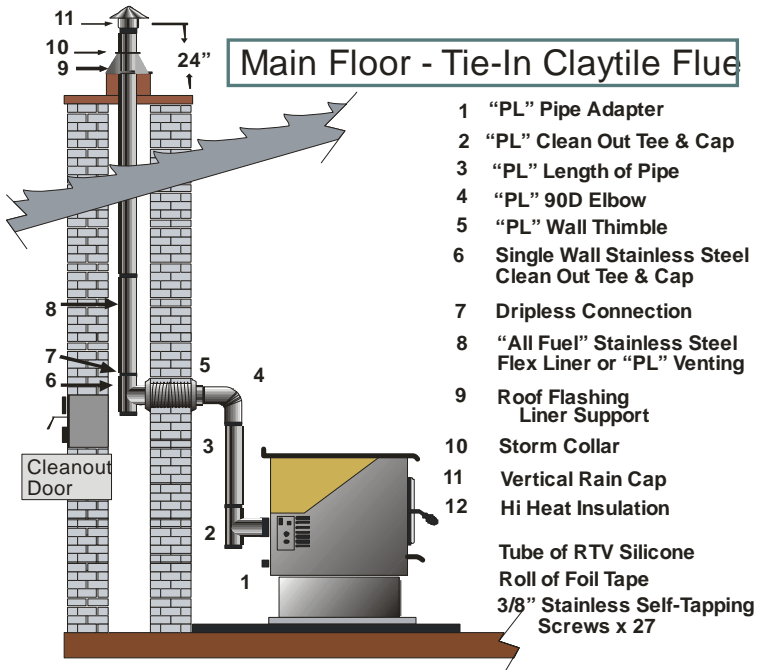

- 1 "PL" Pipe Adapter
 - 2 "PL" Clean Out Tee & Cap
 - 3 "PL" Length of Pipe
 - 4 "PL" 90D Elbow
 - 5 "PL" Wall Thimble
 - 6 Single Wall Stainless Steel Clean Out Tee & Cap
 - 7 Dripless Connection
 - 8 "All Fuel" Stainless Steel Flex Liner or "PL" Venting
 - 9 Roof Flashing Liner Support
 - 10 Storm Collar
 - 11 Vertical Rain Cap
 - 12 Hi Heat Insulation
- Tube of RTV Silicone
Roll of Foil Tape
3/8" Stainless Self-Tapping Screws x 27

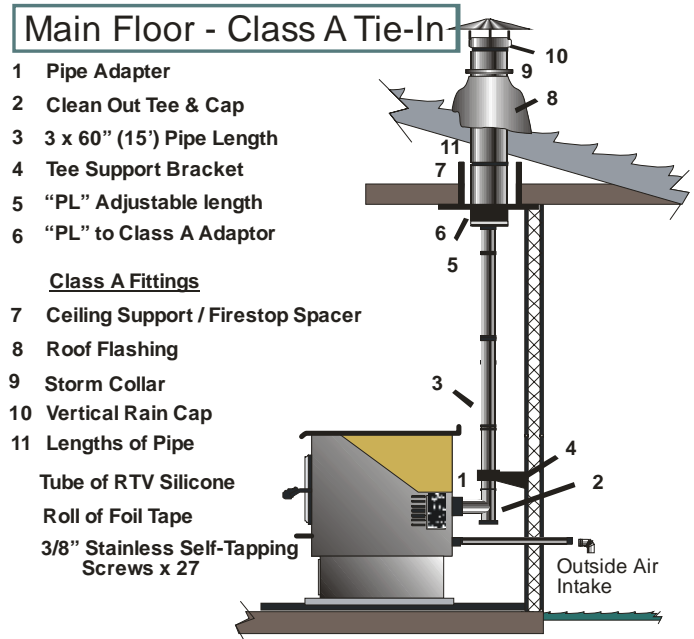

- 1 Pipe Adapter
 - 2 Clean Out Tee & Cap
 - 3 3 x 60" (15') Pipe Length
 - 4 Tee Support Bracket
 - 5 "PL" Adjustable length
 - 6 "PL" to Class A Adaptor
- Class A Fittings**
- 7 Ceiling Support / Firestop Spacer
 - 8 Roof Flashing
 - 9 Storm Collar
 - 10 Vertical Rain Cap
 - 11 Lengths of Pipe
- Tube of RTV Silicone
Roll of Foil Tape
3/8" Stainless Self-Tapping Screws x 27

OPERATING INSTRUCTIONS

COMPLETE THE CHECK LIST (Page 9) PRIOR TO LIGHTING YOUR FIRST FIRE

FOLLOW THE ARROWS TO START YOUR APPLIANCE FOR THE FIRST TIME

IT IS CRITICAL FOR THE CORRECT OPERATION OF YOUR STOVE THAT THE FOLLOWING STEPS BE PERFORMED! A pellet stove, like most things in life is NOT a plug and play appliance.



SETTING THE AIR INLET DAMPER

Because the appliance is made in one location and elevation, then shipped, moved and installed to a different location, at a different elevation, vented differently and then using different fuels. It is not possible for the manufacture to factory set your stove to work properly without some adjustments.

The damper helps to control the amount of airflow supplied for combustion.

Damper **pushed in** all the way airflow is minimum.

Damper **pulled out** all the way airflow is increased.

To get the appliance started, push the air damper in all the way, then pull outward approximately 1/2".

This may not be the final setting.

We will cover FINE TUNNING YOUR STOVE later in this manual.

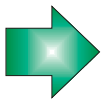

OPENING AND CLOSING THE MAIN DOOR:

Open the stove door by rotating the handle COUNTER CLOCKWISE, toward the TOP of the stove, until the handle is about the 3 o'clock position. Swing door open to the left.

Close the stove door by keeping the handle at the 3 o'clock position. Push the door firmly against the stove. Rotate the handle downward to the 6 o'clock position to lock.

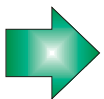

SEATING THE BURN GRATE:

Diagram A

The SUPER GRATE multi-Fuel Burn Grate comes in one piece: (B) and sits in the Burn Pot (A)

Diagram B

Ensure the Multi-Fuel Burn Grate (A) is properly seated in the burn pot and holes are free from obstructions .

The burn grate front lip must sit firmly on the top of the burn pot.

Diagram B and C

You may need adjust the spacer tab (C) if the burn grate fits loosely in the burn pot or if the Igniter hole needs to be closer to the igniter.

To do so grasp the burn grate adjustment tab (C) with a pair of pliers and bend it slightly inward or outward, until the burn grate top rest tightly onto the burn pot and grate fits firmly, with slight play, in the burn pot.

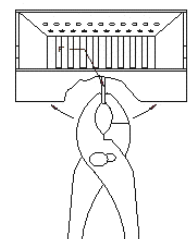
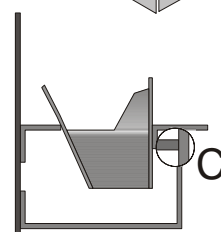
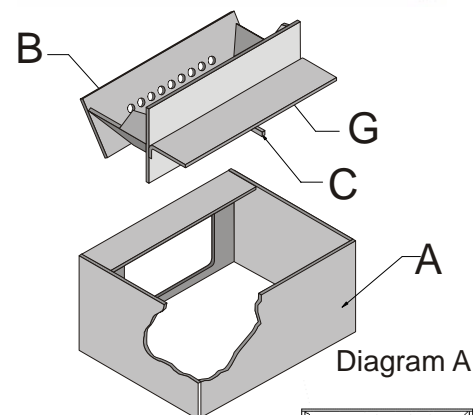
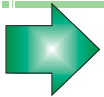

Diagram B

Diagram C

OPERATING INSTRUCTIONS



FILL THE HOPPER WITH FUEL:

Open the hopper lid by placing your fingers in the recessed handle on the hopper lid and lifting upward. Lift the lid until the lid is fully open, toward the back of the stove, and stays open by itself.

Ensure the hopper is clean of any debris, MANUALS, or other foreign objects that could jam up the fuel feed auger.

You may wish to wipe clean any oils, or manufacturing leftovers, using any cleaning agent and a cloth. As well a light application of car wax to the hopper will aid in reducing build-up of dust and fines within the hopper.

Be careful not to spill any fuel on the top of the stove and adjoining gaps. Spilling fuel on the floor can also pose a slipping hazard.

CLOSE THE LID, place finger into the recessed handle and With control, pull the lid toward the front of the stove.

CAUTION: WATCH YOUR FINGERS.

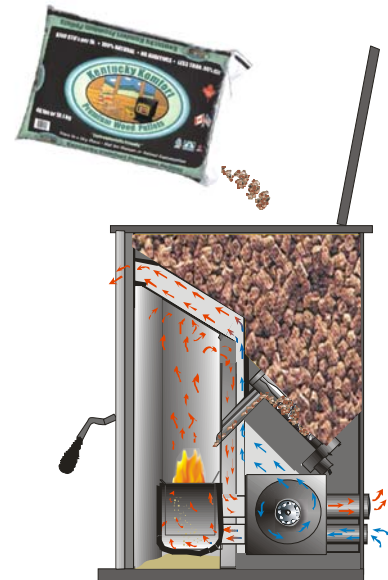

ACUTRON CONTROL II or III w/Memory & Fan Trim

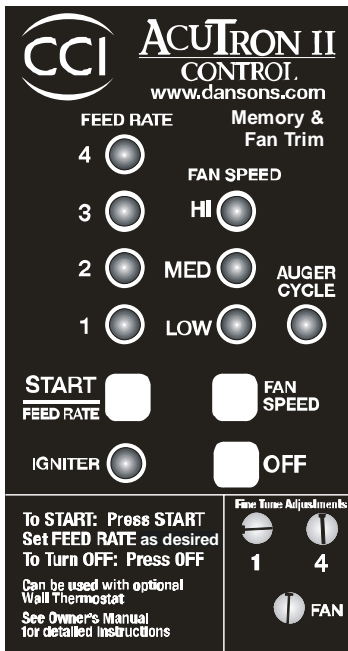

Basic Overview

The AcuTron digital control board with Memory was designed to give you flexibility on how you want to operate your stove. The AcuTron can be operated as a MANUAL control or by a THERMOSTAT. When operating in the Thermostat option, you can also choose to run your appliance in the ON/OFF mode or the LOW/HIGH mode.

The **START** or **FEED RATE** touch pad allows electricity to flow to your stove's electrical components for 15 minutes. If after 15 minutes your stove has heated to normal operating temperatures your stove will continue to run. If the fire does not light and/or burn properly, the electricity to your stove's components will be shut off at the end of 15 minutes.

The **FAN SPEED** controls the speed of the room air fan. This fan blows room air through the heat exchange tubes and back into the room. When the **FEED RATE** is set to a higher position, the **FAN SPEED** should be set higher and visa versa. To achieve optimum heat transfer it is recommended to set the FAN SPEED to LOW or LOW/MED when running the FEED RATE at 1 or 2, and Fan on MED OR MED/HIGH on FEED RATE #3 or 4.

When the **START / FEED RATE** is **ON**, the **AUGER CYCLE** LED will turn on when the auger is active. When the **OFF** touch pad is pushed [OFF], the auger motor will not run, fuel stops feeding and the fire will die.

The **FEED RATE** works in a synchronized manner setting both the fuel rate and combustion air at the same time. When fuel is increased by setting the **FEED RATE** higher, combustion air is automatically increased and visa versa.

MEMORY— If a power outage occurs, the board will remember the function it was performing and return to that function when the power returns.

MODE OF OPERATION SELECTION - All 3 modes of running the control are now activated by using the OFF button to program. (More detail to follow in this section)

FAN TRIM—Allows for fine tuning of the exhaust fan, at the Lower (#1) Feed Rate. This aids in adjusting for fuel, elevation, venting and heating requirements.

OPERATING INSTRUCTIONS

IMPORTANT: If at anytime your appliance does not seem to be operating as it had, **ALWAYS** confirm the mode of operation.

CHOOSE MODE OF OPERATION:

STEP 1 Decide on mode of operation:

Manual Operation Thermostat On/Off or Thermostat Low/High

STEP 2 Find mode of operation:

(For this example we desire the Manual Operation Mode.)

Press and hold in the **OFF** button, while you are holding in the off button the following cycle will

NOTE: The Starting Point of the cycle, depends on what mode the control was in.

Manual
"You are in
control"

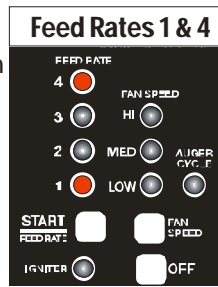

Lights may be difficult
To see from an angle.

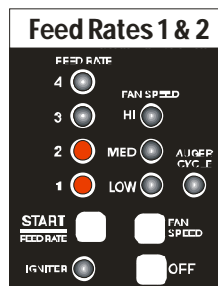
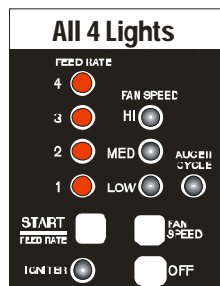

Only be concerned with the **FEED RATE** lights. All others do not effect the mode selection process.

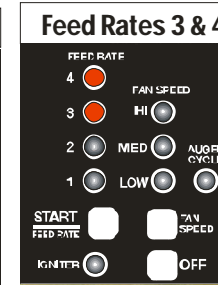
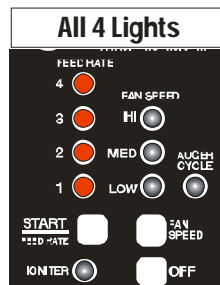

Thermostat
On / Off Mode

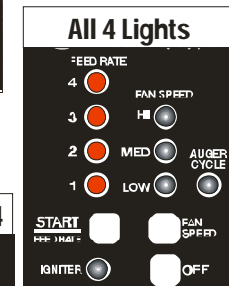

Thermostat
Low / High Mode

Step 3 Set mode of operation:

To choose the mode you want the board to operate in, simply let go of the OFF button when the proper lights flash.

Then press the START touch pad to activate the setting.

OPERATING IN MANUAL MODE:

TO START

Step 1 Press the **START** touch pad. It's that easy!

The control board goes through the entire start up automatically

- Convection (heating) fan will start

- (if a speed was selected before)

- The 300 watt Auto-Igniter will begin to glow and the IGNITER LED will be solid.

- The AUGER CYCLE LED will go solid for 3 seconds, indicating signal is being sent to the Auger motor.

- Combustion (exhaust) fan will start and operate at full speed for

Then will adjust speed automatically to match the feed rate.

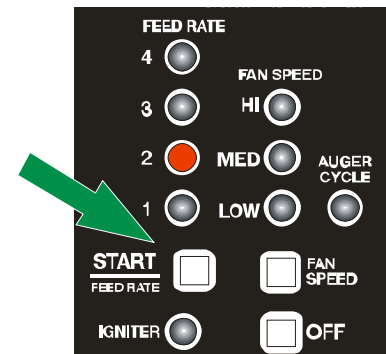

60 seconds,

OPERATING INSTRUCTIONS

TO START ... con't

After Pushing the START touch pad:

The appliance will automatically start in the #1 or low feed rate, no matter where you set it.

When the FEED RATE LED is flashing FAST, this indicates the unit has not reached 120° F exhaust temperature.

When the FEED RATE LED flashes at a SLOWER rate, this indicates the control has reached the 120°F temperature and as entered a 5 minute "Safety Delay"

When the 5 minute "Safety Delay" is complete the IGNITER LED and igniter will turn off and the FEED RATE LED will become solid, meaning you are now in control.

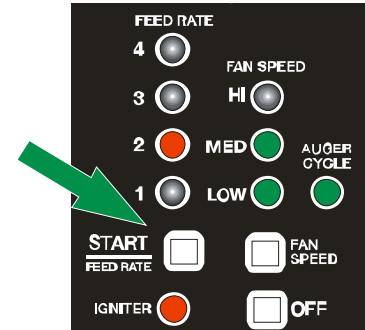

TO ADJUST HEAT

Simply press the START/FEED RATE touch pad to adjust heat output.

Note: During start-up you may adjust the feed rate. This setting will take affect once the Start-up sequence is complete.

TO SHUT DOWN

Press the OFF pad.

OPERATING IN THERMOSTAT HIGH / LOW CYCLE (Flashing 3 & 4)

This requires purchasing the optional "Wall Thermostat Add-on Kit".

This mode of operation is preferred over the ON/OFF mode, during those long and chilly winter nights. The life of the Auto Igniter is greatly increased, and once you have the room to temperature it does not take as much energy to keep it at that temperature.

TO START

Once this mode has been selected, you simply press the START touch pad to activate the stove.

TO ADJUST HEAT

You can now select the HIGH heat output level (2,3 or 4) by pushing the START / FEED RATE touch pad, you can also select the FAN setting you desire. When you have selected your high level and fan speeds the LED's will continue to flash. The appliance will automatically start at the #1 feed rate until the Start-up procedure is complete.

The LOW (number 1) or selected High (2,3 or 4) Feed Rate indicator light will light up depending on if the thermostat is calling for heat or not. When the desired room temperature is reached the stove will automatically go into the low heat (#1) cycle. When the temperature in the room drops to the level set at the thermostat, the stove will again cycle to the HIGH (#2,3 or 4) preselected setting. For optimum heat transfer, the FAN setting should be set at LOW or MEDIUM. The appliance will run the FAN at HIGH speed when needed, automatically.

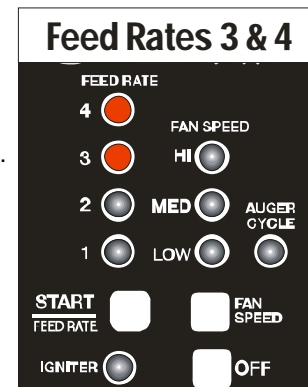

TO SHUT DOWN

To turn off the appliance press the OFF touch pad.

OPERATING INSTRUCTIONS

OPERATING IN THERMOSTAT ON / OFF (Flashing 1 & 2)

This also requires purchasing the optional "Wall Thermostat Add-on Kit"

This mode of operation is best suited for those "Take of the Chill" nights of spring, summer, fall.. The thermostat should be set for the desired room temperature. If the room temperature drops below the level on the thermostat the stove will automatically begin the start-up cycle, as explained in the manual operation section.

In this mode the life of the IGNITER is reduced and the power consumption will be higher. If the thermostat calls for heat while the stove is still cooling down, the stove will go through the START-UP cycle.

TO START

Once this mode has been selected, you simply press the START touch pad to Activate the stove. Once the start-up cycle is completed the stove runs on the pre-selected "HIGH" (number 2,3 or4) setting, till the temperature is reached.

TO ADJUST HEAT

You can select the HIGH heat output level (2,3 or 4) by pushing the START touch pad, you can also select the FAN setting you desire. The stove will now go through its normal start up cycle. Once completed the appliance is now in the ON / OFF mode.

For optimum heat transfer, the FAN setting should be set at LOW or MEDIUM. The appliance will run the FAN at HIGH speed when needed, automatically.

TO SHUT DOWN

The thermostat will shut the stove down when the desired room temperature is reached. The Feed Rate numbers 1 & 2 will flash while the appliance is in the OFF part of this mode to give you a visual indication that the appliance is still active and in the ON / OFF cycle.

HINT: If you find that the stove turns off and on repeatedly, you may wish to turn the FEED RATE to a lower setting. The lower setting will provide a more consistent heat output over time, eliminating the need for the thermostat to repeatedly turn the stove off.

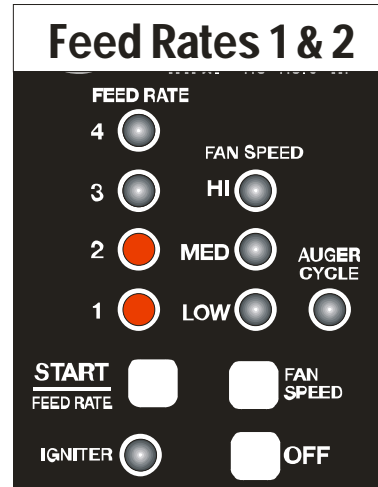

UNDERSTANDING THE CONTROL

TRIM POTS (Fine Tune Adjustments)– Factory Settings

FUEL FEED rates at the Lowest (number 1) and highest (number 4) settings can be adjusted by adjusting the fine tune trim pots located on the control panel. To **raise fuel feed** turn trim pot **counter clockwise** and to **lower** turn **clockwise**. To assist in knowing what the change is you should note the amount of time the light on the AUGER CYCLE LED stays OFF. *(Note: The light stays on when ever the fuel feed motor, AUGER CYCLE, is running).* **Lengthening the time this LED stays OFF lowers the fuel feed and shortening the off-time increases the fuel feed.**

FAN (Combustion) TRIM; this trim may be used to raise or lower the amount of air moving through the burn grate for the cleanest burn, **ONLY** when the control is on the Low Feed Rate (1), and only after the Air Inlet damper has been set during the High Feed Rate (4)..

Note: If you attempt to adjust the Trim Pots, use a small precision screwdriver.

The Trim Pots do not make a full rotation. If using a metal screwdriver, be gentle as the plastic trim pot slot can be damaged or stripped.

AUGER CYCLE

The **AUGER CYCLE** LED indicates when an electrical signal is being sent to the auger motor. It is NOT used to indicate the actual movement of the auger. When the signal is being sent the LED will be solid for 3 seconds. When the LED is off no signal is being sent.

FAN SPEED (Convection or heating)

The **FAN SPEED** controls the speed of the room air fan. This fan blows room air through the heat exchange tubes and back into the room. The FAN SPEED has 5 different speeds, these are controlled by pushing the FAN SPEED touch pad. The Low LED will be solid when on the lowest fan speed, the LOW & MED will both be solid when the next highest speed is selected and so on. When the **FEED RATE** is set to a higher position, the **FAN SPEED** should be set higher and visa versa.

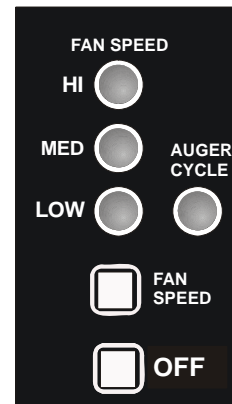
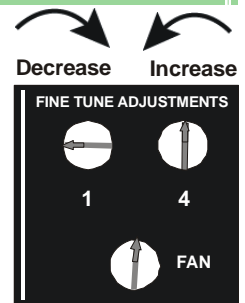

OPERATING INSTRUCTION— LIGHTING YOUR APPLIANCE

Before lighting a fire check to ensure the Burn Grate is clean and adjusted and the Ash Tray is not full.
For safety reasons use extra caution when lighting a stove that is HOT!

Lighting stove manually (No Igniter) In the NON-Thermostat Mode

1. Push firmly on the **FEED RATE** or **START** touch pad.
 - The **COMBUSTION FAN** (exhaust) will start and operate at full speed for 60 seconds, then adjust downward to match feed rate #1
 - The **CONVECTION FAN** (heating) will start and the LED will go solid on LOW setting
 - The **AUGER CYCLE** LED will go solid for 3 seconds, indicating signal being sent to auger motor.
2. Place a small amount of a solid fuel fire starter, such as those made from sawdust and wax or use wood shavings, in the bottom of the burn grate.
Add a small handful of pellets to the starter material.
Add a small amount of fire starter over the pellets.
CAUTION: DO NOT USE ANY FLAMMABLE LIQUIDS SUCH AS GASOLINE, GASOLINE-TYPE LANTERN FUEL, KEROSENE, CHARCOAL LIGHTER FLUID, OR SIMILAR LIQUIDS TO START OR FRESHEN-UP THE FIRE! KEEP ALL SUCH LIQUIDS WELL AWAY FROM THE HEATER WHILE IT IS IN USE.
3. Light the fire starter and slowly close the **MAIN DOOR**, leaving it about 1 inch open. When the pellets are burning, close and latch the main door. If the fire goes out when the main door is closed, add more fire starter, re-light the fire and leave the main door open an inch or so until the pellets start to burn, then close and latch the main door.
4. Adjust the **FUEL RATE** and the **FAN SPEED** to your desired settings you require upon completion of startup sequence.

NOTE: If the fire does not start, your stove will continue to feed pellets and the fans will run for approximately 15 minutes. The stove will then automatically shut off. If this happens, some unburned pellets will build up in the burn grate. To restart the fire, clean the excess pellets out of the burn grate and follow the above "Lighting a Fire".

NOTE: Some odors may be given off a new stove during the initial few hours of burning while the stove and the paint are being cured. These odors are not harmful. However, ventilating the room until the odors disappear is strongly recommended. Run your appliance on HIGH #4 setting and turn off the room heating fan for approximately 1/2 hour, to quickly aid in limiting these odors.

Lighting stove with Auto-Ignitor In the NON-Thermostat Mode

1. Push firmly on the **FEED RATE** or **START** touch pad.
 - The **COMBUSTION FAN** (exhaust) will start and operate at full speed for 60 seconds, then adjust downward to match feed rate #1
 - The **CONVECTION FAN** (heating) will start and the LED will go solid on LOW setting
 - The **AUGER CYCLE** LED will go solid for 3 seconds, indicating signal being sent to auger motor.
 - The **IGNITER** LED will light up solid and the 300 watt igniter will begin to operate.
2. On a primed **AUGER** system pellets will begin to fall into the **BURN GRATE**, and the **AUTO SELF IGNITER** will automatically ignite the pellets in approx. 3 – 5 min.
Note: If stoves fails to light within 15 minutes, shut off the stove, remove the pellets from the burn grate and repeat step 2. If stove fails to ignite a second time, disconnect and contact your dealer.
3. Adjust the **FUEL RATE** and the **FAN SPEED** to your desired settings you require upon completion of startup sequence.

CAUTION: Never use liquid or volatile fire starters to start a fire in your stove! Do not in-stall or operate your stove in any room where any liquid or volatile fuels or any other highly combustible items are in the air or stored in the room. These could cause a safety hazard.

OPERATION— PERFORMANCE ENHANCEMENTS

IT IS CRITICAL FOR THE CORRECT OPERATION OF YOUR STOVE THAT THE BURN GRATE, AIR INLET DAMPER, FAN TRIM AND 1 & 4 FUEL RATE BE SET CORRECTLY!

A **HIGH QUALITY FIRE** should burn with a brisk, vibrant, yellow to white color flame. When watching the fuel burn in the grate, you should see a slight movement. The fuel should not be just setting there, doing nothing, like couch potatoes. At the same time you should not see most the fuel being blown out of the burn grate, commonly know as “Pop Corning”.

Another way to confirm a proper air and fuel mixture is to **view the amount the glowing embers off to the left and right of the burn grate**. If there are no or little embers, the appliance requires more air. If there are a large amount of embers and they continue to glow for over 15 to 30 seconds, the appliance requires less air.

The proper setting will give you some embers, and these embers will last no longer then 15 seconds.

A flame exhibiting a lazy, orange or sooty characteristic is a poor quality and inefficient flame. A poor flame produces less heat, increases sooting and may cause a smoky exhaust. If a poor flame exists for any period of time, clean your stove and exhaust system.

NOTE: It is a good practice to check the quality of your burn every time you start on a new skid of pellets. Because of handling, tree quality, season, transportation, etc., fuel may not be consistent from ton to ton or even bag to bag.

Before performing a “Tune-Up”, ensure the burn grate, burn pot and glass window are clean and free of debris.

If log option is purchased, do not install until fine tuning is complete.

GIVING YOUR APPLIANCE A “TUNE-UP”

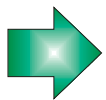

START APPLIANCE AS PER LIGHTING INSTRUCTIONS,

Let the appliance go through the entire START-UP procedure. When the FEED RATE LED stays solid, turn the feed rate to the # 4 setting (or High).

Allow the appliance to run on HIGH for 10 minutes before you begin to make adjustments.



Adjust the AIR INLET DAMPER. This will have to be set, as the factory can not send the units out with the damper pre-set. This is done to accommodate a wide range of installations, elevations and fuel type and quality.

Slide the damper closed (pushed in all the way)

Now open (pull out) the damp approximately 1/8”. Watch the fire.

Check for the characteristics of a good fire, **see above for details.**

If not happy, pull out the damper another 1/8”, again check the fire.

Continue opening the air inlet damper as needed to obtain a fire that is brisk enough to carry ash out of the grate, but not so brisk that it carries full sized pellets out as well (known as “Pop corning”).

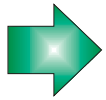

Mark the Adjusted AIR INLET DAMPER.

Once the damper is adjusted correctly, simple take a screwdriver and scrape the paint off the rod, right at the rubber grummet. This will help in finding the right location again if the damper gets moved or adjusted accidentally.

NOTE: The best way and only way to set the Air Inlet Damper is at the FUEL SETTING #4.

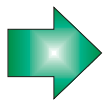

Confirm Low (1) Feed Setting and burn,

only after performing the Air Inlet Damper setting. Check for the characteristics of a good fire, (see above for details, the flame height will not be as tall). If you need to adjust the amount of air going through the burn grate, you can adjust the FAN TRIM pot. Using a small screwdriver, carefully, adjust the FAN TRIM, either up or down (see diagram) to give you the optimum burn and heat desired.

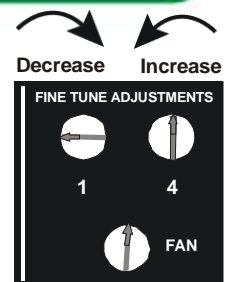

FUEL SPECIFICATIONS—WOOD PELLETS

The performance of your pellet appliance is greatly affected by the type and quality of wood pellets burned. As the heat output of various quality wood pellets differ, so will the performance and heat output of your appliance.

PELLET QUALITY

Your **Glow Boy Series** appliance, with its standard "SUPER Grate", is designed to burn PFII, "Premium" or "Standard" quality wood pellets along with corn and grain or combinations. Pellets that are soft, contain excessive amounts of loose sawdust, have been or are wet, produce clinkers and/or heavy ash will result in reduced performance and may actually cause the fire to go out.



PELLET CONSUMPTION

Fuel consumption will vary somewhat between fuel brands and stoves. The following "**ROUGH GUIDE**" to pellet usage's may be useful in assessing your stove's operation, in ordering fuel and in providing information to your Authorized Dealer.

Fuel Rate Setting...

Setting	Approximate Burn Time on		Amount of pellets burned
	120 lb. hopper	55 lb. hopper	
1	40 – 80 hours	35 – 22 hours	1.50 to 3.00 lbs. Per hour
2	35 – 48 hours	22 – 12 hours	2.50 to 3.50 lbs. Per hour
3	27 – 35 hours	12 – 15 hours	3.50 to 4.50 lbs. Per hour
4	22 – 30 hours	10 – 14 hours	4.00 to 5.50 lbs. Per hour

* Fuel flow and burn times quoted are approximate. And may vary with type of fuel used.

FACTORS EFFECTING PELLET FEED RATES

Generally, the smaller, harder and cleaner, free from fines the pellets are the faster they will feed at a given setting and visa versa. The extremes in pellet size and quality can cause several hours difference in burning time for a 40 pound bag of pellets. Heat production is directly related to the pounds of fuel burned per hour. As fuel consumption goes down so will heat output and visa versa. Pellet feed rate, at the same fuel settings, may vary greatly from brand to brand and may vary somewhat from batch to batch within the same brand.

FINES

FINES in pellets are pieces of sawdust that were not properly formed or are the results of pellets breaking down from handling, transporting and/or storage. Fines adversely affect the operations and heat production of a pellet shop and home heater and greatly increase the requirements for daily and periodic cleaning. Fines cause pellets to feed slower thus reducing the amount of heat produced at any given heat setting.

PFI PELLET STANDARDS www.pelletheat.org

The Pellet Fuel Institute, standards for residential quality pellets are:

Length	1.5 inches, maximum.	Fines:	.1/4 lb. max. per 40lb. Bag
Diameter	.235 to .350 inches, (approx. 1/4" to 3/8").	Salts:	.005 % by weight, maximum
Ash Content:	- Premium Quality .75% by weight, maximum, (.3# per 40# of pellets.) - Standard Quality 2.5% by weight, maximum, (1# per 40# of pellets.)		

Check with your Authorized Dealer on the quality of pellets in your local area and for information on what can be expected from the various local brands.

NOTE: Since Dansons Group Inc. or Canadian Comfort Industries has no control over the quality of pellets, corn or grains that you use, we assume no liability caused by the quality of fuel used.

FUEL SPECIFICATIONS—SHELLED CORN

The performance of your multi-fuel burning appliance is greatly affected by the type, quality, moisture content and consistency of the shelled corn burned. As the heat output of various quality corn differ, so will the performance and heat output of your appliance.



CORN QUALITY

Your **Glow Boy Series** appliance, with its “**Super Grate**”, is designed to burn only dry, clean, quality shelled corn, up to a 50/50 mixture with wood pellets. Cleaning intervals will vary in time from a low of 8 hours to as much as 30 hours of more depending on such factors as; fuel feed rate, hybrid of corn being used, cleanliness, and dryness of fuel, etc.

Shelled Corn must be 14% or lower in moisture. Corn over 14% moisture will not burn.

NOTE: The lower the moisture content the better the burn and higher the heat output. **Problems relating to burning dirty, high moisture corn are not covered under warranty.**

Corn must be screened to make sure it is free of dirt and other debris such as husks, large pieces of cob or other foreign matter. The presence of any of the mentioned items may cause auger jams, inconsistent feed and will result in poor combustion or the fire going out. **Damage caused by dirty corn and other foreign objects are not covered under warranty.**

DO NOT BURN “TREATED” SEED CORN IN YOUR STOVE. Seed corn is treated with chemical pesticides that are harmful if swallowed; therefore, seed corn is dangerous to have in the house, especially where children can access it. **Burning treated seed corn in your heater will void the warranty and will destroy the exhaust system on the unit.**

Do not carry your corn supply over into the next heating season, unless properly stored. If you do decide to carry it over, make sure to check the corn for proper moisture content.

FACTORS EFFECTING FEED RATES

Generally, the smaller and cleaner (free from fine dust and debris) the corn is, the faster it will feed at a given setting and visa versa. The extremes in corn size, moisture and quality can cause several hours difference in burning time for a hopper full of fuel. Heat production is directly related to the pounds of fuel burned per hour and moisture content of the fuel. As fuel consumption goes down so will heat output and visa versa. It is also important to vacuum out your hopper once to twice a month to assure trouble free auguring of the corn.

CORN DUST OR FINES

FINES in corn are dust and pieces of corn shells, cobs, or husks, and are the results of the corn breaking down from handling, transporting and/or storage. Fines adversely affect the operation and heat production of a corn shop and home heater and greatly increase the require-ments for daily and periodic cleaning. Fines cause fuel to feed slower thus reduc-ing the amount of heat produced at any given heat control setting.

STORAGE

STORE corn in a tight container or use other methods to ensure they do not become rain soaked or absorb moisture from damp or wet floors. This will also help to prevent rodents from becoming a problem. Do not store corn within the stove installation clearances or within the space required for clinker removal.

NOTE: It is much easier to remove fines from the fuel before it is placed in the stove than it is to service your stove for a plugged hopper, jammed auger and plugged exhaust system. Pellets, Corn or Wheat with excessive dust or fines may be screened to remove most of the fines. Screeners using a 3/16” mesh screen may be built or purchased from most dealers.

MAINTENANCE—ROUTINE CLEANING

WARNING: Regular maintenance must be conducted for safe and efficient operation. Disconnect power to the stove if maintenance requires the opening of service panels. Conduct maintenance on a COLD appliance only.

Proper care of your **Glow Boy SERIES** pellet appliance is required for peak, sustained performance. The need for and frequency of cleaning depends on the amount of pellets burned, pellet quality, length of time since last cleaning and the quality of the fire. While becoming acquainted with your new stove and the types of local pellets, **inspect your BURN GRATE, BURN POT, HEAT EXCHANGE, ASH PIT, and WINDOW daily and clean until a pattern of cleaning re-requirement is determined.** As heating demands increase the need for stove and exhaust system cleaning and ash removal will increase.

EVERY 2 –3 DAYS / WEEKLY

CHECK BURN GRATE FOR CLINKERS: (B)

If the flames seem to be coming only from the sides, or are orange/black in color, turn the stove off and check for build up in the grate.

The most likely causes are:
Poor quality pellets, exhaust system requires cleaning
The air-inlet damper requires adjustment

To Clean: (Cold Stove Only)

Open door, remove the burn grate, knock out any debris. It may be necessary to scrape the holes clean. Clean between the Burn Grate and Burn Pot as well.

BURN POT: (A) [COLD STOVE ONLY]

Remove the burn grate. Clean out the burn pot area of all debris.

CAUTION: When replacing the grate make sure it fits properly in the burn pot.

WINDOW CLEANING:

[COLD STOVE ONLY as hot glass may cause serious burns]

To enjoy a clear view of the fire you should clean your window as needed with a soft cloth or paper towel. You may use a Fireplace glass cleaner or vinegar water to remove heavy build up on the window.

Mirror cleaners and oven cleaners will leave a film on the glass and attract smoke like a magnet.

HOME TIP: Dampen a piece of newsprint with water, dip this into the fly ash, then rub down the glass. This works like a charm. Do not use abrasive chemical cleaners.

DO NOT OPERATE STOVE WITH BROKEN GLASS AS LEAKAGE OF FLUE GASES MAY RESULT.

DOOR & TRIM CLEANING:

Fingerprints or other marks left on gold surfaces may become etched in place, if they are not wiped clean prior to turning the stove on. Use a damp cloth to wipe clean.

DO NOT USE ABRASIVE CLEANERS AS YOU WILL REMOVE OR SCRATCH THE PLATING!

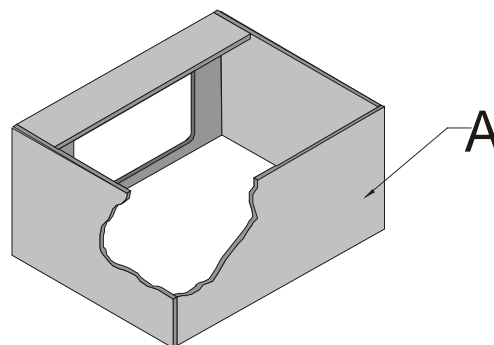
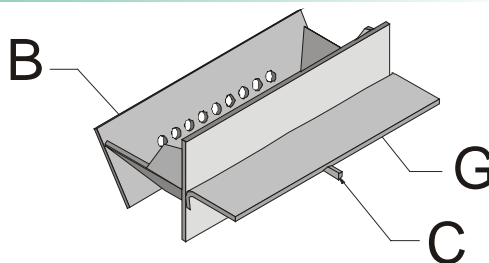

MAINTENANCE— PERIODIC CLEANING

1 TON, SEASONAL OR BI-SEASONAL

The #1 reason for a service call or unit failing is: **FAILURE TO DO SIMPLE PERIODIC MAINTENANCE.**

With proper cleaning and the use of quality pellets, your **Glow Boy Series appliance** requires very little maintenance. However, **the following periodic maintenance is strongly recommended.**

WARNING: Unplug your stove's electrical cord prior to opening the sides of the stove or opening the exhaust system for any inspection, cleaning, maintenance or service work.

NEVER perform any inspections, cleaning, maintenance or service on a HOT STOVE.

ASH CATCH: Open the front door to expose the ash catch area, on the left and right of the burn pot area. Dispose ashes into a metal container with a tight fitting lid. The closed container of ashes should be placed on a Non-combustible floor or on the ground, well away from all combustible materials, pending final disposal.

ASH TRAP: [COLD STOVE ONLY] Remove the back plate from the back of the firewall, by removing the 3 1/4" hex screws. This will expose the 2ash trap. Fly ash may be removed by vacuuming inside the trap area. It is also good to use a brush (bottle cleaner) to reach up and down to scrape the build up off the metal areas.

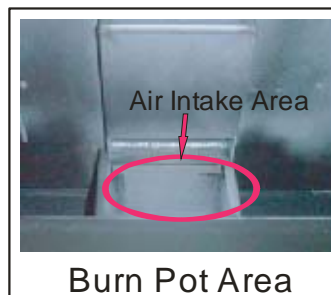

BURN POT: This is the "pot" where the pellets are burned in the grate. When removing your grate for cleaning, check the burn pot area for ash build up. Some ash will fall through the grate holes and build up under the grate. This needs to be cleaned out to prevent lack of air flow through the burn grate. DO NOT push the ash to the back of the opening, as this not an ash trap and will effect or block off the air flow to the grate.

DOOR GASKET: Inspect the main door gasket periodically. The main door may be removed to have frayed, broken or compacted gaskets replaced.

EXHAUST VENTING:

The by products of combustion contain small particles of fly ash. Fly ash will collect in the exhaust venting system and restrict the flow of flue gases. Incomplete combustion, (such as during startup) shutdown or incorrect operation of the room heater will lead to some sort of soot formation which will collect in the exhaust system. Because of this it is important that the exhaust system be **inspected and cleaned at least once a year to determine if cleaning is needed. It is a good practice to inspect after every 1–2 tons of pellet fuel burning.**

Check the clean out tees (4) and elbows (7) in the exhaust system periodically to determine the cleaning schedule. To remove dust from the vent pipe, tap lightly on the pipe to dislodge any loose ash. Open the bottom of the "T" (4) to dump the ash, then vacuum as much of the ash out of the vent pipe as possible.

3 or 4-inch diameter chimney brushes are available for chimney cleaning.

If the exhaust system has a screen (8) on it, frequently clean the screen. A plugged screen will shut off combustion air and cause a fire to die or burn poorly.

WARNING: Whenever any portion of the pellet venting is disconnected, the joints must be sealed, gas tight with High Heat RTV silicone sealant.

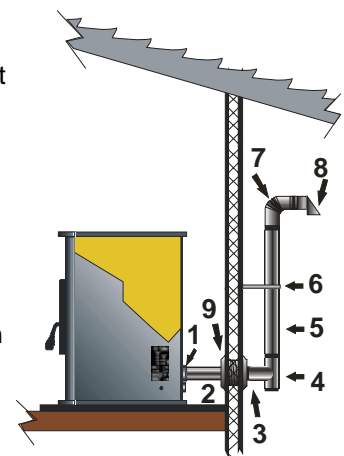

MAINTENANCE— PERIODIC CLEANING

FAN MOTORS: Clean the in-take on CONVECTION (ROOM AIR) fan as well as the air holes on the motors of both COMBUSTION and CONVECTION fans annually.

FRESH AIR INTAKE: Inspect periodically to be sure that it is not clogged with any foreign materials. A plugged screen will restrict or shut off combustion air and cause a fire to die or burn poorly.

GOLD / BRASS / NICKEL /PEWTER TRIM CLEANING: Use a damp cloth to clean your door. **DO NOT USE ANY ABRASIVE CLEANERS AS YOU WILL REMOVE OR SCRATCH THE PLATING!**

CHECK AND CLEAN THE HOPPER:

Check the hopper periodically to determine if there is any sawdust or pellets that are sticking to the hopper surface. Clean as needed. An excess build up of fines, will lead to improper feeding and possible auger jams.

HINT: To aid in the fuel sliding easily down to the auger, you can wipe down the inside of the hopper with a car wax.

GASKET INSPECTION: Air leaks into the firebox will decrease the appliance's performance greatly, leading to excessive sooting inefficient burning and perhaps a malfunction.

Door Gasket—Inspect the door gasket to make sure it is fully attached. Use stove gasket cement to re-attach if necessary. If the door gasket is worn, badly torn or flattened, replace.

Ash Pan—Remove the ashpan and inspect the gasket around the perimeter of the pan. Re-attach or replace the gasket if necessary.

Glass Gasket— There is no gasket across the top or bottom edges of the glass. This is to allow for air wash. Check these areas for build-up or obstructions and clean as needed. The gasketing found on either side edge of the glass does go completely around the corners on the top and bottom to act as a spacer for the glass. If replacing this gasket, ensure the gasket covers the entire side and approximately 1 inch of the top and bottom edges..

GLASS CLEANING : We recommend using a high quality fireplace or stove glass cleaner or a vinegar and water solution along with a rag. Oven cleaner and window cleaners will leave a film on the glass that will attract smoke and creosote like a magnet. Should a build up of creosote or carbon accumulate you may wish to use 000 steel wool and water to clean glass. Ceramic is very hard and will not scratch from the steel wool.

GLASS REPLACEMENT: In the event you need replacement only Hi-Temp Neo-Ceram of the correct size and thickness may be used. Contact your local **Glow Boy SERIES** dealer to obtain this glass. **DO NOT OPERATE STOVE WITH BROKEN GLASS AS LEAKAGE OF FLUE GASES MAY RESULT.**

PAINTED SURFACES: Painted surfaces may be wiped down with a damp cloth. If scratches appear or you wish to renew your paint, contact your Dealer to obtain a can of Satin Black ("Stove Bright") paint.

Tip: use a hair dryer to warm the surface prior to touching up the paint, this helps to reduce paint runs.

Note: Do not use any other brand other than "Stove Bright" as they may not be compatible.

FALL START UP: Prior to lighting the first fire check the outside area around the exhaust and air intake systems for obstructions. Clean the screens on the exhaust system and the outside air intake pipe. Turn all controls on to make sure they are working prior to lighting the first fire. Clean and remove fly ash from exhaust venting.

SPRING SHUTDOWN: [COLD STOVE AND COLD ASHES ONLY]. After the last burn in the spring remove pellets from the hopper and the auger. Scoop out the pellets then run the auger until the hopper is empty and pellets stop flowing. Vacuum out the hopper. Thoroughly clean the burn grate, burn box, ashtray and ash traps. It's desirable to spray the inside of the cleaned hopper with an aerosol silicone spray if your stove is in a high humidity area. The **exhaust system** should be thoroughly cleaned. Disassemble the EXHAUST FAN and CONVECTION FAN and clean off the internal fan blades. Once you are finished, unplug the appliance for added electrical protection.

YEARLY MAINTENANCE

SERVICE CONTRACTS

Many Dansons Authorized Dealers as well as NFI or WETT Certified Pellet Specialists offer yearly customer service contracts. The advantages of these are they establish an ongoing, mutually beneficial relationship with a qualified service technician. Many will offer an end of the season service such as a through cleaning and equipment inspection and repair or replacement, if necessary. There will be a charge for this service.

TROUBLE SHOOTING

Proper cleaning, maintenance and the use of clean, dry, quality fuel will prevent the more common stove operational problems. However, when your stove is simply operating poorly or not at all, the following trouble shooting tips may be helpful.

The following is not an exhaustive list. For more details or updated information please check our website www.dansons.com, and click on customer service, contact your local authorized Dealer or **Dansons Customer Service at 1-877-303-3134.**

**DO NOT return the appliance without calling
Dansons Customer Service for assistance.**

WARNING: Disconnect the electrical cord prior to opening the sides of your stove for any inspection, cleaning, maintenance or service work. **NEVER** perform any inspection, cleaning, maintenance or service on a **HOT STOVE.**

PROBLEM	CAUSE	SOLUTION
Stove Will Not Start	1. No electrical power.	<ul style="list-style-type: none"> *Ensure the stove is plugged in to a 120VAC electrical outlet and a Surge Protection unit. *Check outlet for electrical power and proper voltage. *Check spade connections from the stove power cord to the main wiring harness.
	2. Control Board	<ul style="list-style-type: none"> *Confirm mode of operation. (see OPERATION section for details) *Confirm power to the board by pressing the START touch pad. Do any LED's light up? *Check the 9 pin wire connection to the board. *Inspect the board for any blown circuitry. Before replacing check for the cause of the blown circuit. *It could be a short-out wire or defective electrical component. *Inspect the main wire harness, connections and wire.
	3. No Fuel feed.	<ul style="list-style-type: none"> *Ensure the hopper is filled with fuel. *Securely latch the door. An open door will trip the vacuum switch and disengage the feed auger. *Check the Auger Cycle LED on the control if flashing on and off rapidly this indicates a vacuum problem. *Check vacuum hose for blockage or disconnection *Listen for a faint intermittent hum of an operating feed auger motor. The motor only runs for 3 seconds at a time. *When did the stove stop feeding? During the last use or when you went to start this time. Last use—Check for possible jam, clean out drop chute area.
<p>Ensure door is closed and securely latched.</p> <p>Ensure ash pan is tightly secured.</p> <p>If this is the initial start up or the hopper has run completely empty, it may require a second start-up.</p>		

TROUBLE SHOOTING

PROBLEM	CAUSE	SOLUTION
Stove Will Not Start (cont....)	4. Air Inlet Damper setting	*Check for proper setting. Too much air or not enough air will effect starting time. *Check for blockage in the air intake connector and fresh air intake.
	5. Excessive negative pressure in the room	*Balance pressure in the room by opening a window. *Turn off fan forced exhaust systems.
	6. Clogged exhaust fan or exhaust system	*Inspect and clean venting. *inspect, remove and clean exhaust fan. *Check air passage below and behind the burn grate area.
	7. Defective exhaust fan	*Check for operation of the exhaust blower. Turn off the heating fan, listen for hum next to the exhaust side of the appliance.
Fuel feeds into the burn grate but will not start. Burn grate fills with fuel and then shuts down.	1. Burn Grate is not installed or seated properly.	*The auto igniter will only start wood pellets, corn and grain have to high a moisture content. *Ensure both parts of the grate are installed and seated properly.
	2. Burn Grate is clogged.	*Remove and inspect burn grate. Remove all ash and clinkers. *Ensure air holes are free of debris or build-up.
	3. Igniter is not glowing	*Remove burn grate, close door, and re-start the appliance. If the igniter does not glow red inside the tube it is defective. *Remove back panel and confirm wire connections and condition of wires. *If igniter is defective, the stove can be started manually. See manual lighting instructions.
	4. Air Inlet Damper setting, if igniter is glowing and burn grate is seated properly.	*Check for proper setting. Too much air or not enough air will effect starting time. *Check for blockage in the air intake connector and fresh air intake.
Unit starts, fuel feeds and starts properly, but no heat output	1. Control Board	*Ensure Feed Rate is set to a higher level, *Turn Heating Fan speed down. *Confirm mode of operation.
	2.. Air Inlet Damper setting	*Check the setting of the air damper. It may have be accidently closed or opened all the way. *Follow "Fine Tuning" procedure in this manual.
	3. Fuel	*Check on quality or amount of fines found in the fuel and hopper. *Check the moisture content. *Try different brand or different batch.
	4. Room or Home	*Check air flow patterns, amount of insulation, Location, size of room, ceiling heights and obstructions.

TROUBLE SHOOTING

PROBLEM	CAUSE	SOLUTION
Fire burns with a yellow flame. Fuel builds up in the burn grate. Window gets real dirty quickly.	1. Insufficient combustion air.	<ul style="list-style-type: none"> *Adjust the air inlet damper. *Check for blockage of air intake both inside as well as outside. *Confirm proper placement of burn grate. *Inspect and clean burn grate.
	2. Fuel	<ul style="list-style-type: none"> *Inspect fuel for amounts of fines and debris. *Change to dry clean fuel. *Use high quality premium grade fuel. *Adjust or fine tune feed rates.
	3. Air Leaks	<ul style="list-style-type: none"> *Ensure glass and gasket seated properly *Ensure door is close and latched securely *Check ash pan and gasket, secure and tight.
	4. Combustion Fan	<ul style="list-style-type: none"> *Check and clean ash build up on fan propellers and exhaust intakes and venting. *Check for blockages. *Check for proper voltage to the stove *Replace defective part and gasket.
	5. Exhaust System	<ul style="list-style-type: none"> *Check for blockage, ash build. *Inspect vent cap and clean out tee. *Too many elbows, too long of run, or change size *Protect venting from extreme weather elements.
Smoke or smoke smell spillage.	1. Exhaust System	<ul style="list-style-type: none"> *Hi-Heat RTV silicone all joints even manufactured. Ensure venting is gas tight. *Inspect exhaust fan and gasket area, ensure a tight fit *Proper maintenance and cleaning.
	2. Over Feeding. Fuel overflowing burn grate	<ul style="list-style-type: none"> *Check air inlet damper for proper setting. *Adjust feed rate to lower level
The stove keeps going out.	1. Fresh unburned fuel or powder like ash build up in the grate.	<ul style="list-style-type: none"> *Check air inlet damper, may need more air. *Fine tune feed rate, to lower amount of fuel *Ensure good quality day fuel supply. *Proper maintenance and cleaning.
	2. No fuel or ashes found in The burn grate	<ul style="list-style-type: none"> *Adjust air inlet damper to reduce amount of air to burn grate. Exhaust temperature to low and temperature disk is turning off stove. *Adjust control to increase fuel feed rate.
The stove will not shut off.	1. Control	<ul style="list-style-type: none"> *Press OFF touch pad, the stove will continue to run for 30 minutes after the exhaust has cooled properly *Confirm mode of operation
	2. Wall Thermostat	<ul style="list-style-type: none"> *Ensure wall thermostat is turn down below the room temperature.(Thermostat On/Off Mode) *Unit will not shut off in the (Thermostat Low/High mode). You must press the OFF touch pad.

OPTIONAL ACCESSORIES

OPTIONAL ITEMS

Part No.	Description
KS5150-1450	Fresh Air Intake Kit 3'
KS5150-1460	Fresh Air Intake Kit 10'
KS5130-1480	Hopper Extension—12"
KS5130-1490	Hopper Extension—24"
KS5120-1370	Wall Thermostat Kit Assembly—F



REPLACEMENT ITEMS

Part No.	Description
KS5010-1010	Auger Motor Assembly
KS5010-1020	Auger Shaft Assembly
KS5080-1240	Burn Grate—Super Grate
KS5020-1040	Combustion Fan w/gasket
KS5020-1070	Convection Fan w/gasket
KS5040-1090	Control Board— AcuTron 2
	Door Assembly—black
	Door Assembly—brass trim
	Door Handle
KS5050-1130	Firebrick
KS5060-1160	Gasket—Door
KS5060-1150	Gasket—Window
KS5060-1200	Gasket—Ash Pan
KS5060-1190	Gasket—Exhaust
KS5070-1210	Glass—Neo-Ceramic
KS5030-1060	Igniter Assembly—Home Heater
KS5100-1340	Switch—L120
KS5100-1320	Switch—F140
KS5100-1330	Switch—L250
KS5090-1290	Switch—Vacuum
	Switch—Hopper Lid
KS5110-1350	Wire Harness—Main AcuTron



SEE YOUR "Glow Boy" DEALER FOR ADDITIONAL INFORMATION OR TO ORDER.

ACCESSORIES

Hopper Clean-Out Drop Chute



You would have found this along with your Owner's Manual, Allen –Key, exhaust gasket and inspection card. This can have two purposes. The main one is to be an attachment to the side of the hopper to help with cleaning out the hopper.

The second purpose would be used as a dust pan for your shop.

Keep this separate till needed.

Purpose:

Should you find in necessary to remove the pellets from your hopper, for any reason, this handy attachment will save time and a lot of effort.

Tools Needed:

¼" Hex Nut setter & Driver or Flat Head Screwdriver
Pail or bin

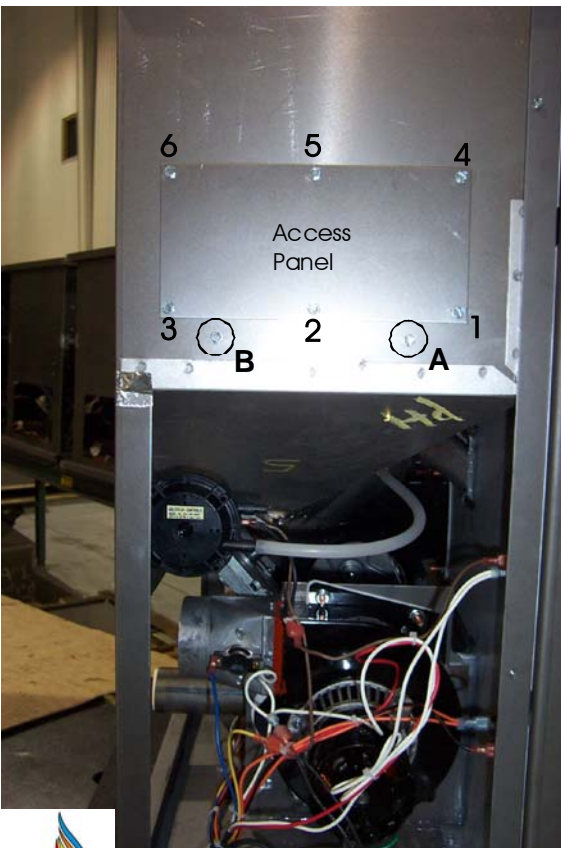

How to Install:

Unplug the appliance power cord from the wall outlet.

To gain access to the inside of the appliance, remove the ¼" hex screws from the LEFT HAND SIDE PANEL (looking from the front of the heater). These are located on the back left hand side corner of the appliance.

Remove the panel simply by sliding it back toward the exhaust.

Remove the 2 – ¼" hex screws, labeled A & B.

Install the Hopper Drop Chute, re-installing the screws.

Remove the 5 - ¼" hex screws from the side hopper access panel. Number 1 – 5 (see picture)

Loosen the #6 screw, but leave it attached. This now allows the access panel to act as a door.

Place a catch pail under the drop chute.

Raise and lower the access panel as needed.

When finished cleaning out as many pellets as possible, re-install the 5 screws, remove the drop chute, replace the 2 screws and then install the side panel.



LIMITED WARRANTY

The "**Glow Boy**" wood pellet appliance, carries a five (5) year limited warrant for from the date of sale to the original owner against defects and workmanship on all steel parts, (excluding the burn grate), and one (1) year on electrical components. There is no specific warranty on the paint, glass, burn grate, fire brick and all gaskets or against damage caused from corrosion.

Extended Warranty

Canadian Comfort Industries will offer an additional **one (1)** year limited warranty on electrical component parts, when your "**Glow Boy**" wood pellet appliance is installed by a "**Dansons Certified Installer**".

To qualify for this extended warranty the unit must be installed by a "Dansons Certified Installer" and the "**Pre-Delivery & Install Check List**" form must be filled out and received at Canadian Comfort Industries Fax 1-780-960-0430 or online at www.dansons.com/support

There is no written or implied performance warranty on "Glow Boy**" stoves, as the manufacturer has no control over the installation, operations, cleaning, maintenance or the type of fuel burned.**

This limited warranty will not apply if your stove has not been installed, operated, cleaned and maintained in strict accordance with the manufacturer's instructions. Burning other than quality wood pellets may void the warranty. The warranty does not cover damage or breakage due to misuse, improper handling or modifications.

The limited warranty registration card must be signed and returned to **CANADIAN COMFORT INDUSTRIES, INC.** by the owner. Appropriate information is to be noted on the card.

All claims under this limited warranty must be made through the dealer where your stove was purchased. If an inspection by the dealer indicates that a limited warranty claim is justified, and all conditions of this limited warranty have been met, the manufacturer's total responsibilities and liabilities shall be to repair or replace, at the manufacturer's option, the defective part(s). All costs of removal, shipment to and from the dealer or manufacturer, any losses during shipment and reinstallation, and any other losses due to your stove being removed, shall be covered by the owner of the stove.

NEITHER THE MANUFACTURER, NOR THE SUPPLIERS TO THE PURCHASER, ACCEPTS RESPONSIBILITY, LEGAL OR OTHERWISE, FOR THE INCIDENTAL OR CONSEQUENTIAL DAMAGE TO THE PROPERTY OR PERSONS RESULTING FROM THE USE OF THIS PRODUCT. ANY WARRANTY IMPLIED BY LAW, INCLUDING BUT NOT LIMITED TO IMPLIED WARRANTIES OF MERCHANTABILITY OR FITNESS, SHALL BE LIMITED TO ONE (1) YEAR FROM THE DATE OF ORIGINAL PURCHASE. WHETHER A CLAIM IS MADE AGAINST THE MANUFACTURER BASED ON THE BREACH OF THIS WARRANTY OR ANY OTHER TYPE OF WARRANTY EXPRESSED OR IMPLIED BY LAW, MANUFACTURER SHALL IN NO EVENT BE LIABLE FOR ANY SPECIAL, INDIRECT, CONSEQUENTIAL OR OTHER DAMAGES OF ANY NATURE WHATSOEVER IN EXCESS OF THE ORIGINAL PURCHASE PRICE OF THIS PRODUCT. ALL WARRANTIES BY MANUFACTURER ARE SET FORTH HEREIN AND NO CLAIM SHALL BE MADE AGAINST MANUFACTURER ON ANY ORAL WARRANTY OR REPRESENTATION.

Some states do not allow the exclusion or limitation of incidental or consequential damages, or limitations of implied warranties, so the limitations or exclusions set forth in this limited warranty may not apply to you. This limited warranty gives you specific legal rights and you may have other rights, which vary from state to state.

Parts, Service and Returns

It is Dansons Inc. policy, that NO pellet appliance be returned to any dealer without prior authorization from Dansons Technical Service Department.

We strongly suggest that if you do need to order any parts or options or require service, that you first deal with your local dealer. Many dealers do stock parts and options. The majority of the parts names can be found within this manual.

If for any reason you do not have a local dealer, Dansons Inc. is proud to offer the best technical and sales support in the industry. **Call TOLL FREE 1-877-303-3134.**

Additional Dansons Products

www.louisiana-grills.com

www.countrysmokers.com

[Check our website for up to date accessories, options and information!](#)



