

FLAME WOOD STOVE MANUAL



By:



STOVE BUILDER INTERNATIONAL INC..

1700, Leon-Harmel, Quebec City (Quebec)

Canada G1N 4R9

Tel : (418) 527-3060

Fax : (418) 527-4311



All Flame stoves are tested by Warnock Hersey according to CSA and ULC standards

THE FLAME WOOD STOVE MANUAL

TABLE OF CONTENTS

INTRODUCTION	3
THE FLAME WOOD STOVE MANUAL	3
WOOD HEATING.....	3
THE CONTROLLED COMBUSTION WOOD STOVE.....	3
INSTALLATION OF YOUR FLAME WOOD STOVE.....	4
<i>POSITIONING THE STOVE</i>	4
<i>FLOOR PROTECTION</i>	4
<i>CLEARANCES TO COMBUSTIBLE MATERIALS</i>	5
<i>INSTALLATION OF A HEAT RADIATION SHIELD</i>	6
<i>STEP BY STEP INSTALLATION OF YOUR CHIMNEY</i>	8
<i>COUPLINGS</i>	15
EXTERIOR AIR INTAKE.....	16
AIR CIRCULATION SYSTEM.....	16
OPERATING YOUR FLAME WOOD STOVE.....	17
<i>FUEL</i>	17
<i>IGNITION</i>	18
MAINTENANCE OF THE HEATING SYSTEM.....	21
<i>MAINTENANCE OF THE STOVE</i>	21
<i>MAINTENANCE OF THE CHIMNEY</i>	22
PROCEDURES IN CASE OF FIRE.....	22
FREQUENTLY ASKED QUESTIONS.....	23
LIMITED LIFETIME WARRANTY.....	30

INTRODUCTION

THE FLAME WOOD STOVE MANUAL

Stove Builder International inc (SBI), one of the most important wood stove and fireplace manufacturers in North America, congratulates you on your purchase and wishes to help you get maximum satisfaction from the wood stove you have selected. In the pages that follow, we will give you advices on wood heating and controlled combustion as well as technical specifications regarding installation, operation and maintenance of the model you have chosen.

The instructions pertaining to the installation of your wood stove comply with ULC #S627 standards. You must follow them very carefully in order to eliminate any chance of encountering major problems.

Read this entire manual before you install and use your new stove. If this stove is not properly installed, a house fire may result. To reduce the risk of fire, follow the installation instructions. Failure to follow instructions may result in property damage, bodily injury or even death.

PLEASE CONSULT LOCAL AUTHORITIES, BUILDING DEPARTMENT OR FIRE MARSHALL ABOUT RESTRICTIONS, INSTALLATION REQUIREMENTS AND FOR THE NEED TO OBTAIN A PERMIT BEFORE YOU INSTALL YOUR WOOD STOVE.

KEEP THIS INSTRUCTION MANUAL FOR FUTURE REFERENCE.

WOOD HEATING

Many consumers choose wood as the main or auxiliary energy source for heating their dwelling or secondary residence. This source of energy has the advantage of being abundant, relatively cheap and easy to store so that you are assured of energy autonomy for more or less longer periods.

THE CONTROLLED COMBUSTION WOOD STOVE

The main feature of a controlled combustion wood stove is an air tightness that is the most perfect possible, and must of course be equipped with the most efficient heat exchanger possible in order to transfer maximum heat to the ambient air. It is generally doubled with firebricks, and it may have a glass door, with steel or cast iron frame. The main feature that makes it a controlled combustion wood stove remains its air tightness, which allows the user to control the quantity of oxygen admitted into the wood stove.

The wood will burn slowly if the wood stove draught keys are adjusted in order to reduce the oxygen supply in the combustion chamber to minimum; on the other hand, wood will burn quickly if the draught keys are adjusted to admit a larger quantity of oxygen in the combustion chamber.

INSTALLATION OF YOUR FLAME WOOD STOVE

POSITIONING THE STOVE

It is very important to position the wood stove as close as possible to the chimney, and in an area that will favor the most efficient heat distribution possible throughout the house. The stove must therefore be installed in the room where the most time is spent, and in the most spacious room possible. Recall that wood stoves produce radiating heat, the heat we feel when we are close to a wood stove. A wood stove also functions by convection, that is through the displacement of hot air accelerated upwards and its replacement with cooler air. If necessary, the hot air distribution from the stove may be facilitated by a blower or the installation of floor or wall grids. **Except for model The Lieutenant II, it is strictly forbidden to install your wood stove in a mobile home.**

Important:

A wood stove must never be installed in a hallway or near a staircase, since it may block the way in case of fire or fail to respect required clearance. The wood stove must not be hooked up to a hot air distribution system since an excessive accumulation of heat may occur.

FLOOR PROTECTION

Your woodstove should be placed on a non-combustible surface. Having these minimum specifications.

FLOOR PROTECTION				
Models	Thickness of floor protection	Front protrusion	Side protrusion	Rear protrusion
The Advantage I	1/4" (6 mm)	18" (457 mm)	8" (203 mm)	8" (203 mm)
The Diplomat	1/4" (6 mm)	18" (457 mm)	8" (203 mm)	8" (203 mm)
The Ambassador	1/4" (6 mm)	18" (457 mm)	8" (203 mm)	8" (203 mm)
The Lieutenat II	1/4" (6 mm)	18" (457 mm)	8" (203 mm)	8" (203 mm)
The Executive	1/4" (6 mm)	18" (457 mm)	8" (203 mm)	8" (203 mm)
The senator II	1/4" (6 mm)	18" (457 mm)	8" (203 mm)	8" (203 mm)
The General II	1/4" (6 mm)	18" (457 mm)	8" (203 mm)	8" (203 mm)

CLEARANCES TO COMBUSTIBLE MATERIALS

It is of utmost importance that the clearances to combustible material mentioned on your wood stove certification plate be scrupulously respected upon installation.

CLEARANCES				
Model	Back wall	Side walls	Corners	* Height
The Advantage I	24" / 610 mm	24" / 610 mm	24" / 610 mm	7' / 2,13 m
The Diplomat	26" / 660 mm	26" / 660 mm	26" / 660 mm	7' / 2,13 m
The senator	16" / 406 mm	17" / 430 mm	17" / 430 mm	7' / 2,13 m
The Lieutenant II	15" / 381 mm	16" / 406 mm	8" / 203 mm	7' / 2,13 m
The Executive	15" / 381 mm	22" / 559 mm	14" / 360 mm	7' / 2,13 m
The General II	17" / 430 mm	18" / 457 mm	18" / 457 mm	7' / 2,13 m
The Ambassador	24" / 610 mm	26" / 660 mm	26" / 660 mm	7' / 2,13 m
	Single pipe / Double pipe	Single pipe / Double Pipe	Single pipe / Double pipe	
The Lieutenant II	15" (381mm) / 7" (180mm)	16" (406mm) / 12" (305mm)	8" (203mm) / 5" (130mm)	7' (2,13 m)
The Lieutenant II (Mobile Home)	15" (381mm) / 10" (255mm)	16" (406mm) / 14" (360mm)	8" (203mm) / 6" (150mm)	7' (2,13 m)

* Height, from floor protection to ceiling.

You may decrease these clearances by installing heat radiation shields between the walls or the ceiling and the stove. These heat radiation shields must be installed permanently, and can include sheet metal, a rigid non-combustible sheet or a masonry wall. The installation standards of such heat radiation shields are listed on the following page.

IT IS STRICTLY FORBIDDEN TO PLACE WOOD WITHIN THE MINIMUM CLEARANCES.

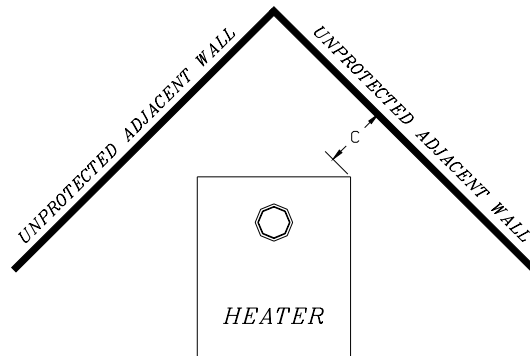
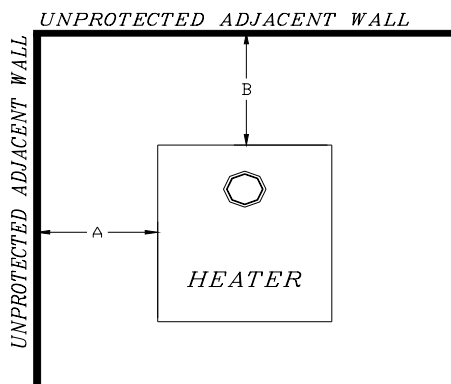

INSTALLATION OF A HEAT RADIATION SHIELD

Following the installation of a heat radiation shield, the clearances mentioned on the stove certification plate may be reduced as stated in the following table.

TYPE OF PROTECTION	Reductions in clearance to a combustible wall (or ceiling) and the heating device, %	
	SIDES AND REAR\BACK	TOP
Minimal requirements: 0,013" (0,33 mm) sheet metal with 1" (25.4mm) fire-proof braces	67%**	50%
Ceramic tile or an equivalent fire-proof material resting on fire-proof brackets spaced 1" (25.4mm) apart by fire-proof braces	50%	33%
Ceramic tile or an equivalent fire-proof material built on a fire-proof base resting on sheet metal of at least 0,013" (0,33 mm) thick spaced 1" (25.4mm) by fire-proof braces.	67%	50%
Solid bricks, spaced 1" (25.4mm) from the rear wall using fire-proof braces.	50%	N/A
Solid bricks, resting on sheet metal 0,013" (0,33 mm) thick spaced 1" (25.4mm) from the rear wall using fire-proof braces.	67%	N/A

**Example: 15 inches x (100% - 67%) = 4,95 inches.

This reduction in clearance, when in compliance, is accepted by insurance companies.

CHIMNEY

Your wood stove may be hooked up with a prefabricated or masonry chimney. If you are using a prefab chimney, it must comply with S-629 standards; therefore it must be approved for up to 1200°F (650° C). It is extremely important that it be installed according to the manufacturer's specifications.

If you are using a masonry chimney, it is important that it be built in compliance with the specifications of the National Building Code. It must be lined with refractory bricks, metal or clay tiles sealed together with fire cement. (Round flues are the most efficient).

The interior diameter of the chimney flue must be identical to that of the stove smoke exhaust. A flue which is too small may cause draft problems, while a large flue favors rapid cooling of the gas, thus enhancing creosote build-up and the risk of chimney fires. Current practice requires that the area of the chimney flue do not exceed the stove exhaust area by more than 35%. For a round pipe, 35% of the area represent approximately 1" (25 mm) on the diameter. (ex: For a stove with an exhaust of 6", the chimney flue should not exceed 7" of diameter.) Note that it is the chimney and not the stove which creates the draft effect; your stove's performance is directly dependent on an adequate draft from your chimney.

The following recommendations may be useful for the installation of your chimney:

- 1) It must rise above the roof at least 3' (0,9 m) from the uppermost point of contact.
- 2) The chimney must exceed any part of the building or other obstruction within a 10' (3,04 m) distance by a height of 2' (0,60 m).
- 3) Installation of an interior chimney is always preferable to an exterior chimney. Indeed, the interior chimney will by definition be hotter than an exterior chimney, being heated up by the ambient air in the house. Therefore the gases which circulate will cool more slowly thus reducing the build-up of creosote and the risk of chimney fires.
- 4) The draft, which is created by the tendency for hot air to rise, will be better with an interior chimney.
- 5) You must not install more than one heating unit per chimney flue.
- 6) The use of a fire-screen at the extremity of the chimney requires regular inspection in order to insure that it is not obstructed.

STEP BY STEP INSTALLATION OF YOUR CHIMNEY

Note: The way to install your chimney may vary from one chimney manufacturer to another. The instructions contained in this manual are based on the recommendations of chimney manufacturers whose products are sold at many Canadian retailers of wood stoves and related heating accessories.

WALL SUPPORT SYSTEM

If your chimney must rise along an outside wall, you need to connect it to your stove through an adjacent wall. For this type of installation, the following items are normally required :

Chimney

- Suitable lengths of chimney (enough to go up to your roof)
- An adjustable wall support
- A wall thimble
- An adequate number of wall bands (one for every 8 feet of chimney, excluding the roof portion)
- A stove pipe adapter
- One insulated tee & plug
- A chimney cap.
- Roof guys (if required)

Stove pipe

- An adequate number of stove pipe sections.
- A 90° elbow

- 1- Start by positioning your stove where you would like it to go, taking into account the minimum clearances to combustible material. You will then be able to determine where the chimney will pass through the wall. You will probably have to adjust the stove position slightly to ensure that your chimney will run between the studs. You can use a stud finder to locate the studs. Use a spoke saw or jig saw to cut a hole, remembering that you need to maintain a clearance of 2 inches between the chimney and any combustible materials. For concrete walls, cut a hole slightly larger than the outer diameter of the chimney.



- 2- Once the opening completed, you need to frame in the area to allow for the installation of a wall thimble. A wall thimble is not required for installations through concrete walls.



- 3- You must first secure the wall thimble into the exterior wall surface. Then, do the same inside and fasten the trim plate.



- 4- Then, from outside the building, slide a short chimney length (attached to the tee) through the wall thimble. The chimney must extend at least 3 inches into the living space where it attaches to the stove pipe.



- 5- You can now install the wall support. Simply slide the wall support up to the tee, ensuring that the adapter on the support engages with the female coupler on the bottom of the tee. When the wall support is level and properly positioned, you can use lag bolts to secure it into the wall studs. TO complete the installation, install an insulated tee plug below the wall support.



- 6- You can start to add chimney sections. We recommend that you also use locking bands to secure all connections. You will need to secure the chimney to the house using wall bands. Wall bands wrap around the chimney and then attach to the wall. Install the first one 3 feet above the wall support. Then, you will need another band for each 8 feet of chimney. **Note: if your chimney must be installed through your soffit, install a roof flashing above and finishing plate below where the roof is cut. Consult the following section called "CEILING SUPPORT SYSTEM" for more details.**



- 7- Authorities require that the chimney extend not less than 3 feet above the highest point where it passes through the roof of a building and not less than 2 feet above any portion of the building within 10 feet. If the chimney extends more than 5 feet above the roof deck, roof guys with telescoping legs and draw bands are required.



- 8- Finally, twist on your rain cap and you can head back inside.



- 9- You are now ready to connect your chimney to your stove. Simply install the inter-connecting stove pipe between the stove pipe adapter and the stove. You can follow the instructions in the following sections of this manual under « COUPLINGS ».



CEILING SUPPORT SYSTEM

If your chimney must rise inside the house and go through the ceiling, you need to connect it to your stove at the ceiling level. For this type of installation, the following items are normally required :

Chimney

- An adequate number of chimney sections (enough to go up to your roof)
- A ceiling support kit with stove pipe adapter
- An attic insulation shield
- A roof flashing kit
- A chimney cap
- Roof guys (if necessary)

Stove pipe

- Suitable lengths of stove pipe
1. Place your stove where you would like it located and use a plumb line to mark the ceiling directly above your stove flue. You will probably have to adjust this position slightly to ensure that your chimney will run between the joists. You can use a stud finder to locate the joists. You also need to take into account the minimum clearances to combustible materials. After you have determined where the chimney will go through the ceiling, use a spoke saw or power jig saw to cut a hole, remembering that you need a minimum 2-inch clearance between the chimney and

any combustible materials. Depending on whether you have a one or two story structure, you will need to cut a matching hole through the floor of the attic or second floor living space.



2. Before you install the ceiling support, you need to frame the area.



3. To install the ceiling support, just slide the assembly into the framed opening from below. Once you ensure that the finishing plate is flush with the underside of the ceiling and assembly is level, secure it with screws.



4. Once the support is secure, you can begin to assemble the chimney by lowering the first section into the support. Make sure that the male coupler is pointing upwards, as indicated by the arrow on the chimney label.



5. Then, from beneath the support, insert the stove pipe adapter and twist-lock it into place.



6. Now, you can add additional chimney sections. Continue adding chimney lengths until a height of about 2 feet below the next ceiling level. An attic insulation shield must be installed where a chimney passes from a lower living space into an upper living space or attic space. It is designed to keep insulation materials away from the chimney. A second attic insulation shield must be installed if your chimney passes from a lower living space into an upper living space. As we, you must enclose all sections of the chimney where it passes through a living space. Elbows (15° or 30°) are used when you need to offset your chimney to clear an obstruction or to avoid having to cut joists.

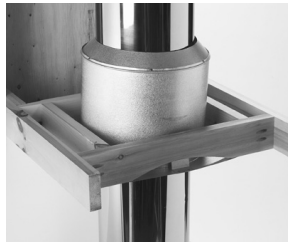

7. Once you have cut through your roof and framed the joists, it is time to work outdoors. Authorities require that the chimney extend not less than 3 feet above the highest point where it passes through the roof of a building and not less than 2 feet above any portion of the building within 10 feet. You will need to install a roof flashing. The roof flashing slides over your chimney pipe and goes under your shingles. Once you have done that, check that everything is plumb, and nail the flashing into the roof deck. Seal the joint between the shingles and the plate with silicone.



8. Next, slide the storm collar down the chimney until it contacts the flashing. Tighten the nut and bolt and seal the collar to the chimney with a waterproof, non-combustible silicone sealant.

Finally, twist on your rain cap and you can head back inside. If the chimney extends more than 5 feet above the roof deck, roof guys with telescoping legs and draw bands are required.



9. You are now ready to connect your chimney to your stove. Simply install the inter-connecting stove pipe between the stove pipe adapter and the stove. You can follow the instructions in the following sections of this manual under “COUPLINGS”.



COUPLINGS

It is very important to measure the clearance between your connectors (commonly called stove pipe) and the surrounding combustible surfaces. If the normal 18 inches clearance required cannot be obtained, you may have to use an insulated flue pipe in order to install. You must read the flue pipe manufacturer's instructions before installation.

Your connectors and chimney must have the same diameter as the stove outlet. If this is not the case, we recommend you contact your supplier in order to insure there will be no problem with the draft. Your connectors should be made of aluminized or ordinary steel with a minimum 24 gauge thickness.

Your smoke exhaust system (connectors) should be assembled in such a way that the male section of the pipes faces down. Attach each of the sections to one another with three equidistant metal screws.

The connectors must be short and straight. All sections installed horizontally must slope at least 1/4 inch per foot, with the upper end of the section toward the chimney.

To insure a good draft, the total length of the exhaust system should never exceed 8 to 10 feet. (Except for cases of vertical installations or cathedral-roof, where the smoke exhaust system can be much longer and connected without problem to the chimney at the ceiling level). There should never be more than one 90° elbow in the smoke exhaust system.

Installation of a "barometric draft stabilizer" (fireplace register) on a smoke exhaust system is prohibited.

Furthermore, installation of a draught damper is not recommended. Indeed, with a controlled combustion wood stove, the draught is regulated upon intake of the combustion air in the stove and not at the exhaust.

The connectors must not go through a ceiling, a storage area, a floor, or any other combustible partition.

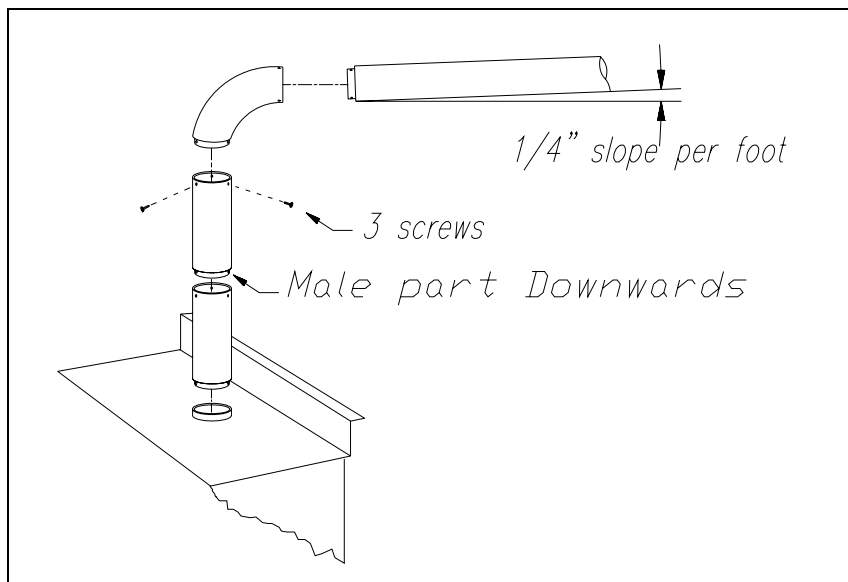

EXTERIOR AIR INTAKE

Since the Lieutenant has been approved for installation in mobile homes, it is equipped with an optional exterior air intake kit. The procedure for installation of the exterior air intake is as follows:

Rear wall connection

Determine the position on the wall, cut out a 4" (152 mm) diameter hole, position the screen from outside and join the insulated duct from the screen to the attachment flange on the back of the pedestal of the stove.

NOTE: Spacing between the wall and the insulated duct will be sealed with silicone in order to insure continuity to the vapor barrier.

Attach the unit to the floor using the two screws provided for this purpose.

AIR CIRCULATION SYSTEM

In order to improve air circulation in the room where the wood stove is installed, certain options are available for specific stove models.

Blower: A variable speed-control blower is available. Consult your dealer.

Thermodisc kit: Available on most models, the thermodisc is a sensor that connects to the blower's electrical supply cord, and it will start the blower when the stove's temperature reaches 120° F (49°C) and cut off power when the stove cools down below 100° F (37°C). Information regarding installation of the thermodisc is included with the device. Consult your dealer.

OPERATING YOUR FLAME WOOD STOVE

FUEL

Your stove was designed to burn wood only. No other type of fuel should be used. Waste and other flammable materials are prohibited. Any type of wood may be used in your stove, but specific varieties have better energy yields than others. Please consult the following table in order to make the best possible choice.

AVERAGE ENERGY YIELD OF ONE AIR DRIED CORD OF CUT WOOD

High energy yield	
Wood type	Energy yield (in millions of BTU/cord)
Oak	29
Sugar maple	28
Beech	26
Medium energy yield	
Yellow	25
Ash	24
Elm	23
Douglas fir	23
Red maple	23
Larch	23
Silver birch	22
Low energy yield	
Alder	18
Poplar	17
Hemlock	17
Spruce	17
Pine	17
Bass	16
Fir	13

Data provided by Energy, Mines and Resources - Canada

It is **EXTREMELY IMPORTANT** that you only use **DRY WOOD** in your wood stove. The wood must have dried for 9 to 15 months, so that the humidity content is reduced below 20% of the weight of the log. It is very important to keep in mind that even if the wood has been cut for one, two or even more years, it is not necessarily dry, especially if it has been stored in poor conditions. Under extreme conditions, it may even have rotten instead of drying. This point cannot be overstressed enough; the vast majority of the problems related to the operation of a wood stove is caused by the fact that the wood used was too damp or had dried in poor conditions. These problems can be:

- Ignition problems.
- Creosote build-up causing chimney fires.
- Low energy yield.
- Blackened glass door.
- Incomplete log combustion.

Smaller pieces of wood will dry faster. All logs exceeding 6" (152 mm) should be split. The wood should be stored in a place where the grass is not too long, in such a way that prevailing winds may circulate through the fire logs. A 24" to 48" (610 mm to 1219 mm) air space should be left between each row of fire logs, which should be placed in the sunniest location possible. If the wood must be stored outside, the upper layer of wood should be protected from rain and bad weather but not the sides.

Before your first fire:

- Check if firebricks are lined-up properly.
- If applicable, remove the plastic protector covering the gold trims.
- Make sure that the chimney and flue pipe are well installed according to specifications.
- Respect all clearances to combustibles and floor protection according to the unit you have chosen.
- If you are not sure that your installation is adequate, do not hesitate to contact your Flame dealer.

IGNITION

The installation of a log cradle is **NOT RECOMMENDED** in your **FLAME** wood stove.

After making sure that the stove air intake controls are fully open, place several crumpled sheets of paper at the center of the firebox. Place 8 to 10 pieces of small dry kindling wood over the paper in the form of a tent. You may also place a few pieces of firewood, but choose them as small as possible. No chemical product (or accelerant) should be used to light the fire.

Before igniting the paper and kindling wood, it is recommended that you warm up the chimney. This is done in order to avoid backdraft problems often due to negative pressure in the house; cold air from the outside tends to penetrate into the house by the chimney and creates a "clog" effect.

If such is the case, open a window slightly near the stove and twist together a few sheets of newspaper into a torch. Light up this paper torch and hold it as close as possible to the mouth of the pipe inside the firebox to warm up the chimney. Once the updraft movement is initiated, you are ready to ignite the stove by lighting the paper and kindling wood inside the combustion chamber.

We advise you to leave the door slightly open (a few inches) for a 5 to 10 minutes period, under supervision, in order to allow for good combustion. After this time, you may close the door and progressively adjust the air controls to obtain the desired temperature.

CAUTION:

- Do not leave the stove unattended when the door is slightly open.
- When the stove is used for the first time, intense fire is prohibited in order to allow adequate curing of the paint covering the stove and to prevent a "thermal shock" which may remove or whiten the paint.
- Make sure the room is well ventilated, to remove the bad odors emitted from the paint, during the first two or three hours of usage.
- Never heat the stove outside the house before you install it. It is impossible to adequately monitor the combustion intensity, which may cause overheating and a thermal shock to the paint.
- Never use fluid or chemical products to ignite the fire.
- Do not burn wastes, flammable fluid such as gasoline, naphtha or motor oil.

HEATING

Once you have obtained a good bed of embers you should reload the unit. In order to do so, open the air control completely for a few seconds prior to opening the stove door. Then, proceed by opening the door very slowly. Open it by one or two inches for 5 to 10 seconds before opening it completely. This will increase the draft and will eliminate the smoke, which is stagnant in a state of slow combustion. Then, bring the red embers to the front of the stove and reload the unit. Use only the quantity of wood required depending on the circumstances; for example, in severe cold weather, load the stove to maximum. During milder temperatures, the stove should be only half loaded. **CAUTION : DO NOT PLACE LOGS TOO CLOSE TO THE GLASS OR THE DOOR. IF LOGS ARE TOO CLOSE TO THE GLASS OR THE DOOR, THEY MAY FALL WHEN YOU OPEN THE DOOR. FURTHERMORE, THE LOGS THAT ARE TOO CLOSE MAY DAMAGE THE GLASS IF YOU SHUT THE DOOR TO HARD.**

When possible, we recommend that you operate the stove with a wood load approximately equivalent to the height of the fire bricks. If you constantly load the stove above the fire bricks, you may damage the firebox and cause the paint to whiten.

It is extremely important that you use your stove in such a way that you do not lower the temperature of the combustion gases inside the chimney too much. For this purpose, we strongly recommend that you install a chimney thermometer on your exhaust pipe, approximately 18" above the stove. Contact your Flame dealer in order to buy one. This thermometer will indicate the temperature of your exhaust gases inside the exhaust system. The ideal temperature range is indicated on the thermometer. If temperature is too low, the build-up of creosote is promoted while if temperature is too high, heat is wasted since too large a quantity is emitted into the atmosphere.

In summary, it is very easy to operate your wood stove and you can prevent all potential problems by following these recommendations:

- 1) Select a stove of adequate size: selecting a stove that is too big for the area to be heated is a common mistake;
- 2) Follow the installation standards scrupulously and respect the clearances to combustible material;
- 3) Burn only dried wood, that is, with a maximum 20% humidity content;
- 4) Install a chimney thermometer on your stove pipe, 18" (457 mm) above the stove, and maintain the temperature of your exhaust gases between 250°F and 475°F.

Keep in mind that the most difficult months for wood heating are October and November. Indeed, during this period, the atmosphere is often very heavy and humid, and may hinder the chimney draft. Moreover, the wood is often too damp, since it has not had a sufficient drying period, or it has been stored outside in the rain. Combustion problems may then occur.

Important:

It is important to note that wood combustion consumes ambient oxygen in the room. In the case of negative pressure, it is a good idea to allow for a fresh air intake in the room, either by opening a window slightly or by installing a fresh air intake system on an outside wall.

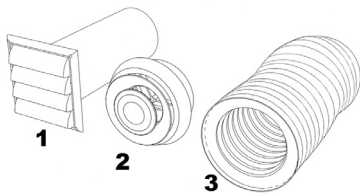

MAINTENANCE OF THE HEATING SYSTEM

MAINTENANCE OF THE STOVE

Our wood stoves are designed so that they will require little maintenance:

- It is wise to perform a visual inspection of the stove approximately once a month, in order to insure that no parts have been damaged, in which case repairs must be performed without delay.
- If the glass on your stove breaks, you must replace it with one of the same type, namely, a 3/16" (5 mm) thick ceramic glass; never replace the glass with another material.
- To replace the glass, remove the screws retaining the window moldings inside the door, (except for the Royal Comfort where the screws are located on the outside of the door). Remove the moldings and replace the damaged glass with a new one.
- Never wash the windows with a product that may scratch it. Use a specialized product, available in the stores where wood stoves are sold.
- Windows should be washed only when they are cold.
- It is recommend that you change the fiber ceramic gasket that makes the door on your stove airtight. Replacement should take place once a year under normal conditions. This is important to insure good control over the combustion, maximum efficiency, and security. To change your door gasket, simply remove the old gasket and carefully clean the door groove. Install the new gasket by carefully following the instructions on the gasket packaging. **IMPORTANT: different models of Flame wood stoves require different types of gasket. You need to buy the original gasket supplied by the manufacturer. Avoid low density gasket, which often comes with liquid glue. Only high temperature silicone should be used. Consult your dealer.**
- You should regularly dispose of the ashes, as soon as they prevent you from placing a normal load of logs. We recommend that you always leave one to two inches of ashes in the bottom of the stove in order to insure maximum efficiency.
- Always use a metal container with a lid to save the cooled ashes you remove from the stove. Make sure that there are no live embers. Moreover, it is important to place the metal container on a non combustible surface.
- Never bang the door and never hit the glass. When you close the door, make sure the logs are placed in such a way that they do not lean on the glass. Otherwise, someone could open the stove door and cause the burning logs to fall on the floor.
- It is possible to give your wood stove a brand new look by repainting it with a 1200° F (649 °C) heat resistant paint. For this purpose, simply rub the surface with fine sand paper #180. The closer to the metal you go, the tougher the paint coat will be. Clean the stove and apply thin coats of paint successively. Remember that upon ignition of the stove, the new paint will go through a "curing" process and will produce smoke and odors. This is normal. Leave a window open.

MAINTENANCE OF THE CHIMNEY

Whether you have a prefab or masonry chimney, you must conduct a visual inspection at least once a month in order to be sure that it is in good shape and that there is no excessive creosote build-up. If there is the slightest crack, or undulation of the interior or exterior surface of the chimney, repairs or replacements of defective parts must be carried out without delay.

You should do at least one chimney sweeping per year, or more if your visual inspection reveals creosote deposits exceeding 1\4" (6 mm). **It is important to remove all creosote which has been detached with the sweeping brush, in order to prevent it from igniting when you start your next fire.**

PROCEDURES IN CASE OF FIRE

IN CASE OF FIRE:

- **POSITION THE AIR INTAKE OF THE STOVE AT THE MINIMUM TO DEPRIVE IT FROM OXYGEN.**
- **CALL IMMEDIATELY THE FIRE DEPARTMENT.**
- **IF YOU HAVE A FIRE EXTINGUISHER, USE IT.**
- **IF THE FIRE AND THE SMOKE PREVENT YOU FROM APPROACHING THE STOVE, TELL ALL THE OCCUPANTS OF THE HOUSE TO IMMEDIATELY GO OUTSIDE AND LEAVE THE HOUSE.**

FREQUENTLY ASKED QUESTIONS

WHAT DO THE WORDS “DRAFT” AND “NEGATIVE PRESSURE” MEAN?

The word “**draft**” refers to the hot air movement that circulates in your stove’s exhaust system, moving from the stove to the outside of the house, and carrying with it the combustion residues. The draft is a natural phenomenon. Hot air weights less than cold air, causing it to rise. This is why the higher the temperature in the exhaust system, the stronger the draft. It is also important to say that the “tunnel effect” created by the exhaust system contributes to increase the draft effect. This is why chimneys that are excessively long often create excessive draft, while chimneys that are abnormally short will have an excessively low draft. The following are often symptoms of a draft problem:

- Excessively dirty (blackened) glass;
- A fire that has a tendency to die quickly when the stove door is closed;
- A stove that does not heat enough.

“**Negative pressure**” can be seen as a “reverse draft”. That is, air will circulate from the chimney toward the interior of the house. Negative pressure is often what causes smoking problems. In general, negative pressure is the result of either one or a combination of the three factors explained below:

- 1- A cold chimney. Cold air, which is heavier than hot air, has a tendency to go down the chimney and create the effect of a “clog”. This explains why a stove that has not worked for a long time and which chimney is very cold will sometimes be hard to light and cause smoking problems.
- 2- Negative pressure can also be caused by a “vacuum effect” in the room or the house. The air in a house is constantly moving. Hot air rises, cold air moves down. Air can also be mechanically expelled outside of the house with the use of air-moving devices, such as a range hood, a air exchanger, a dryer, a bathroom fan, etc. Furthermore, air goes in and out of the house through cracks, doors, windows, etc. If air leaves a room without being replaced, a “vacuum effect” is created. Therefore, if a house is well insulated and all windows are closed, the room will source its air through the easiest alternative route, which is often your stove’s exhaust system. This creates a negative pressure in your exhaust system. You now understand why it is often suggested that a window be slightly open in the room where the stove is located. This enables the room to easily source its air from outside the house without searching for an alternative route. The vacuum effect can amplified when your stove is located in the basement. This is due to the fact that your house itself acts like a chimney. Since hot air will rise to upper floors, it will “draw” air from the basement of the house. This phenomenon is called the “chimney stack effect”.
- 3- Wind can also be a third cause of negative pressure. When your house is located near a structure which height is superior to your roof’s, wind currents can create an interference with your chimney, leading to negative pressure problems.

Drawings #1 to #5 starting on the next pages will help you understand the explanations provided in this section.

DRAWING #1

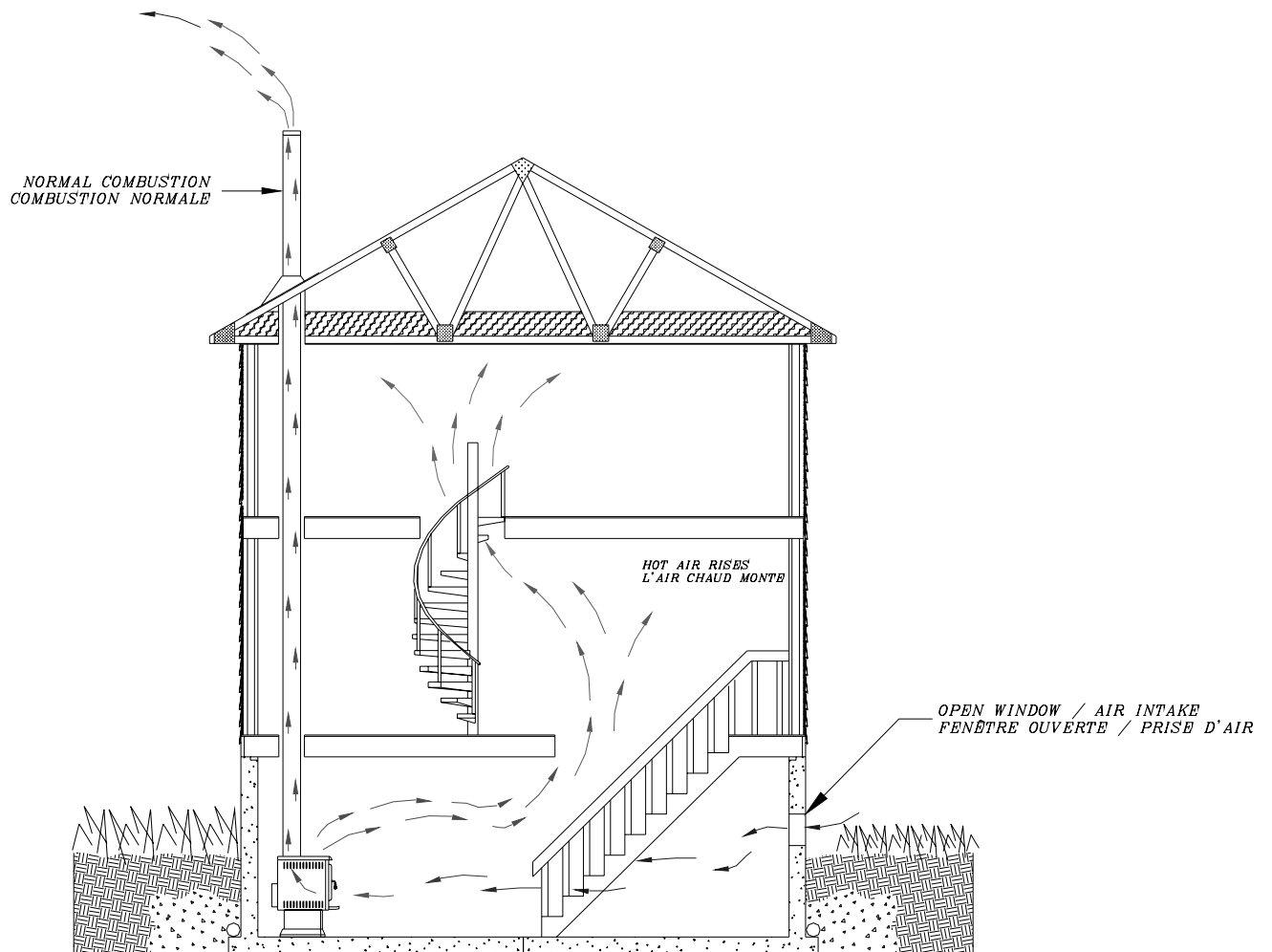

DRAWING #1 shows a stove functioning under normal and adequate conditions. Heat rises to the upper floors and the room where the stove is located has an adequate supply of oxygen. The chimney draft is sufficient and the combustion gases are evacuated normally through the exhaust system.

DRAWING #2

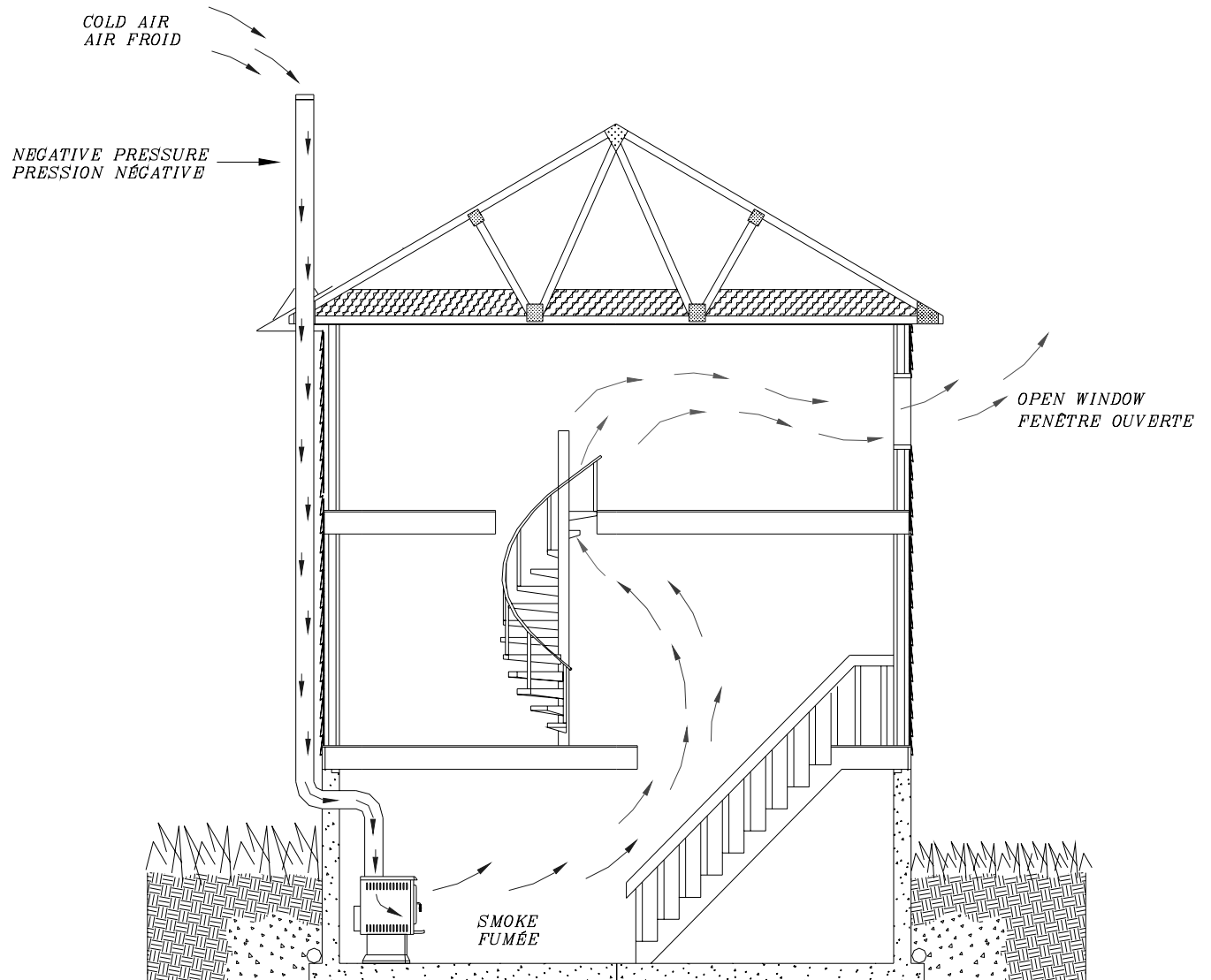

DRAWING #2 shows the effect of a cold chimney. Cold air creates a reverse draft (negative pressure), which causes smoking problems. This phenomenon is amplified by the fact that heat rises, which creates a draft from the basement of the house to the upper floors (“chimney stack effect”).

DRAWING #3

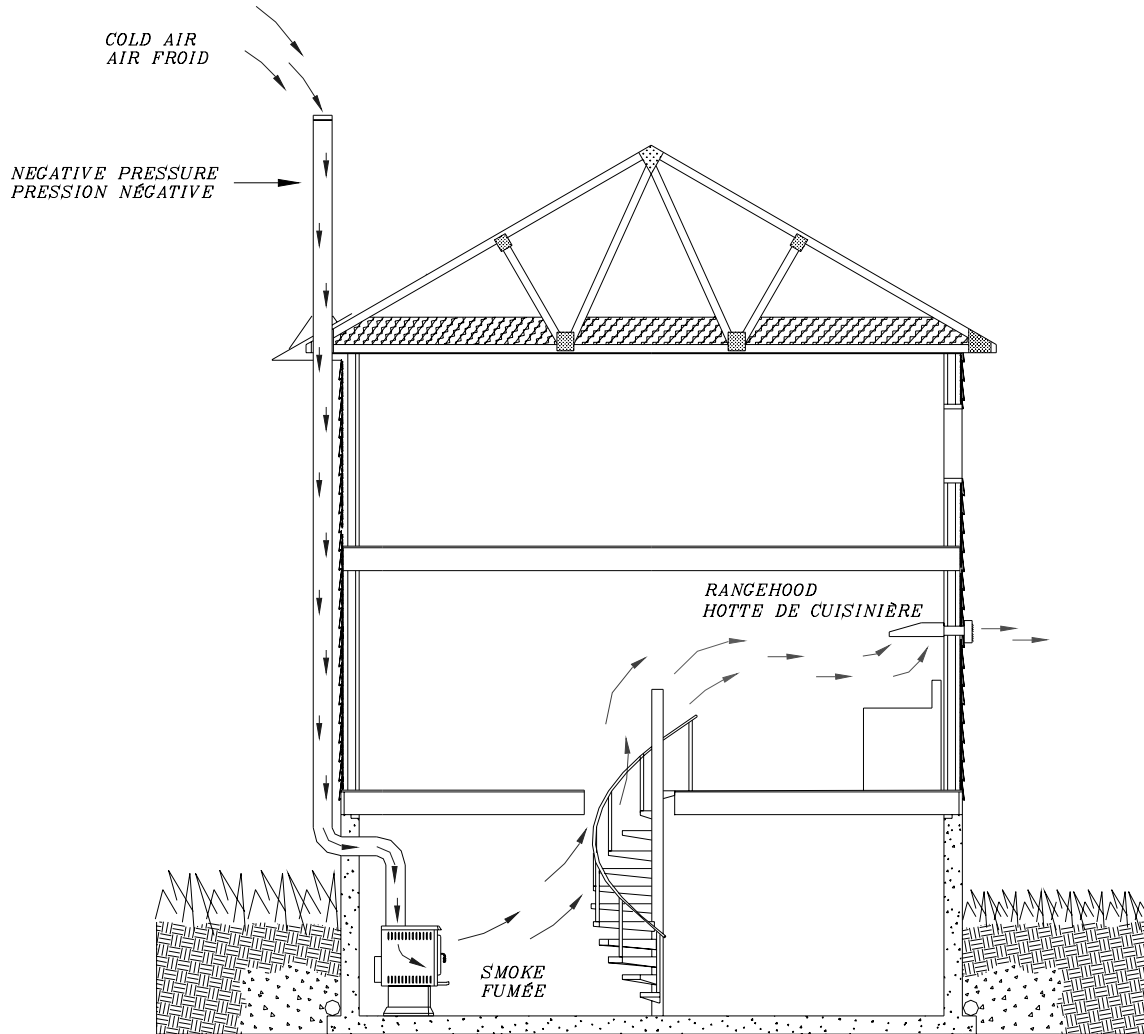

DRAWING #3 shows the effect of negative pressure caused by an air-moving device inside the house. In the example above, the range hood draws air from inside the house, which is replaced by air coming from the chimney. The result is a smoking problem.

DRAWING #4

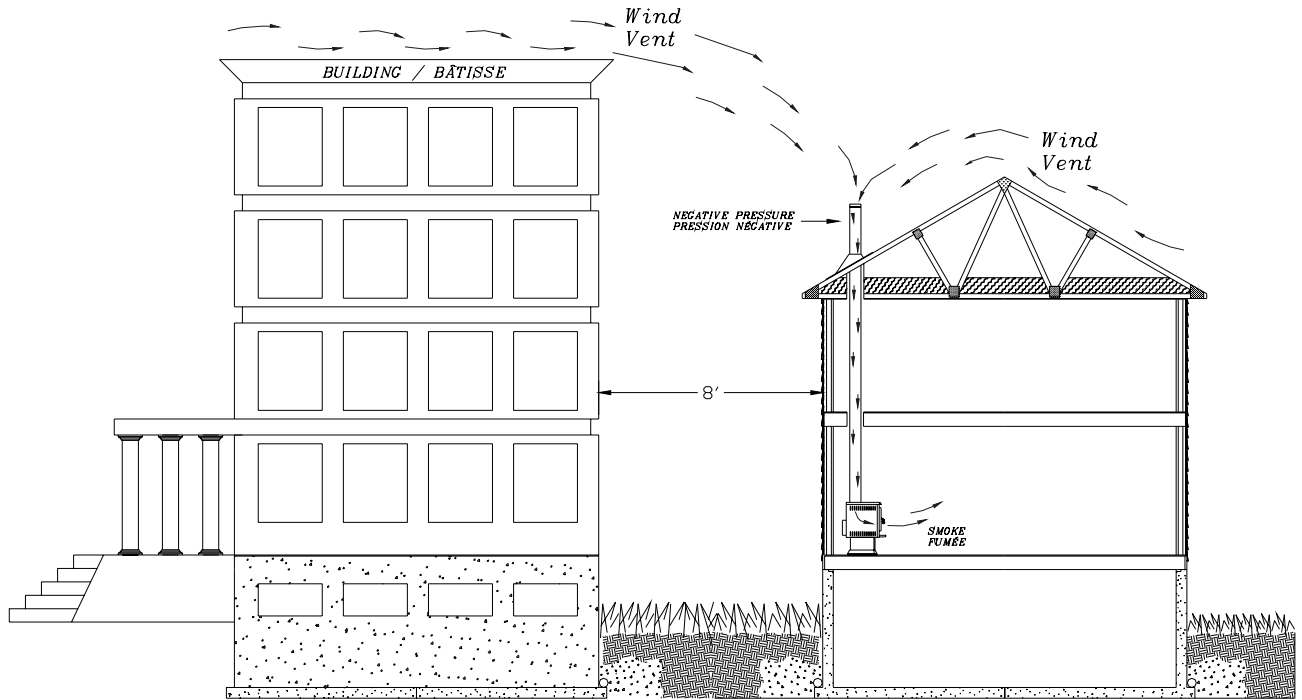

DRAWING #4 shows the negative pressure effect caused by wind, influenced by nearby structures such as a building.

DRAWING #5

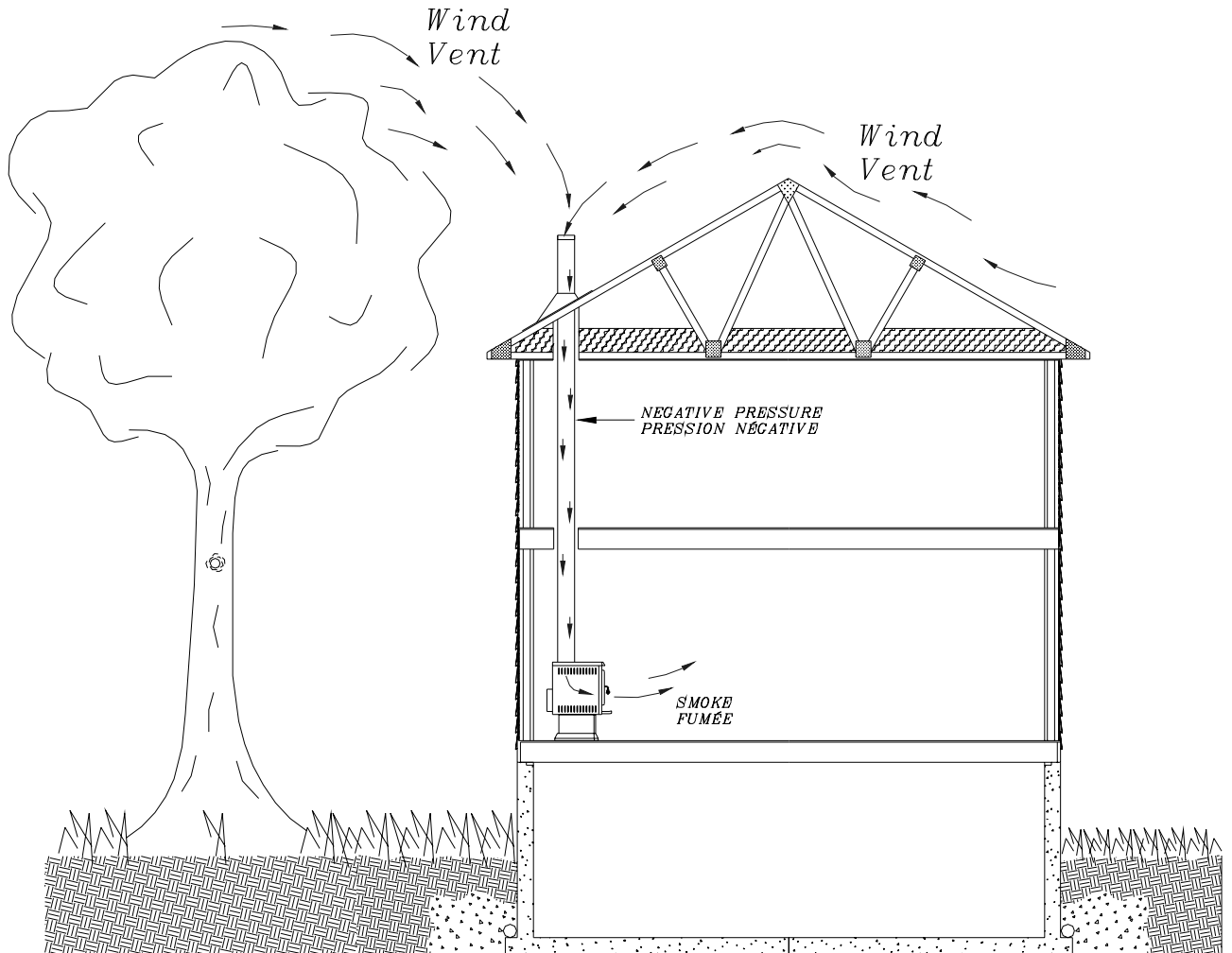

DRAWING #5 shows the negative pressure effect that can be caused by wind, influenced by nearby structures such as a tree.

CAN I MODIFY MY STOVE TO INSTALL A GLASS DOOR?

It is forbidden to modify a stove. Stoves are safety tested with a specific configuration, drawings of which are filed with the regulating authorities. Changing the type of door could lead to serious difficulties with your insurance company in case of fire. It would also automatically nullify your warranty.

WHEN DO I NEED TO REPLACE THE FIREBRICKS?

The firebricks in your stove are there to protect the steel from the excessive heat of the flames and embers. Without firebricks, your stove would wear out prematurely. It could also become too hot and cause objects or structures nearby to catch fire. If you notice that some firebricks are disintegrated and the steel is directly in contact with the fire or embers, replace the firebricks immediately. If you only notice cracks on some firebricks, it is not necessary to replace them. The frequency at which you will change your firebricks depends on how often you use your stove.

There are different sizes of firebricks. Most stores will sell firebricks with a dimension of 4,5"X9"X1,25". These firebricks are adequate for many stoves, but will not fit on all Flame units. It is preferable that you visit our parts section in order to clearly identify the type of firebrick that you need.



1700 Leon Harmel, Quebec City (Quebec), Canada G1N 4R9
 Tel. : (418) 527-3060 Fax : (418) 527-4311

LIMITED LIFETIME WARRANTY

The warranty of the manufacturer extends only to the original consumer purchaser and is not transferable. This warranty covers brand new products only, which have not been altered, modified nor repaired since shipment from factory. Proof of purchase (dated bill of sale), model name and serial number must be supplied when making any warranty claim to your Flame dealer. **This warranty applies to normal residential use only. Damages caused by misuse, abuse, improper installation, lack of maintenance, over firing, negligence or accident during transportation are not covered by this warranty.** This warranty does not cover any scratch, corrosion, discoloration or warping caused by over firing, abrasives or chemical cleaners. Any defect or damage caused by the use of unauthorized parts or others than original parts void this warranty. An authorized qualified technician must perform the installation in accordance with the instructions supplied with this product and all local and national building codes. Any service call related to an improper installation is not covered by this warranty. Returned products are to be shipped prepaid to the manufacturer for investigation. If a product is found to be defective, the manufacturer will repair or replace such defect and reasonable transportation fees will be refund. Repair work covered by the warranty, executed at the purchaser's residence by an authorized qualified technician requires the prior approval of the manufacturer. Labour cost and repair work to the account of the manufacturer are based on predetermined rate schedule and must not exceed the wholesale price of the replacement part. The manufacturer at its discretion may decide to repair or replace any part or unit after inspection and investigation of the defect. The manufacturer may, at its discretion, fully discharge all obligations with respect to this warranty by refunding the wholesale price of any warranted but defective parts. The manufacturer shall in no event be responsible for any special, indirect, consequential damages of any nature, which are in excess of the original purchase price of the product.

DESCRIPTION	WARRANTY APPLICATION	
	PARTS	LABOUR
Combustion chamber (welds only)	Lifetime	5 years
Stainless baffle	5 years	1 year
Carbon steel baffle and secondary air tubes	2 years	1 year
Handle assembly	5 years	n/a
Ash drawer	Lifetime	1 year
Cast iron parts	5 years	1 year
Ceramic glass (thermal breakage only)	1 year	n/a
Paint, refractory bricks, gasket, blower, thermal switch (thermodisc) and rheostat	1 year	n/a
Plated surfaces (tarnishing)	1 year	n/a

Should your unit or component be defective, contact immediately your **Flame** dealer. Prior to your call make sure you have the following information necessary to your warranty claim treatment:

- You name, address and telephone number;
- Bill of sale, dealer's name;
- Serial number and model name as indicated on the nameplate fixed to the back of your unit;
- Nature of the defect and any relevant information.

Before shipping your unit or defective component to our plant, you must obtain from your Flame dealer an Authorization Number. Any merchandise shipped to our plant without authorization will be refused automatically and returned to sender.