

The One & Only
EARTH STOVE™

PELLET APPLIANCE SERVICE MANUAL

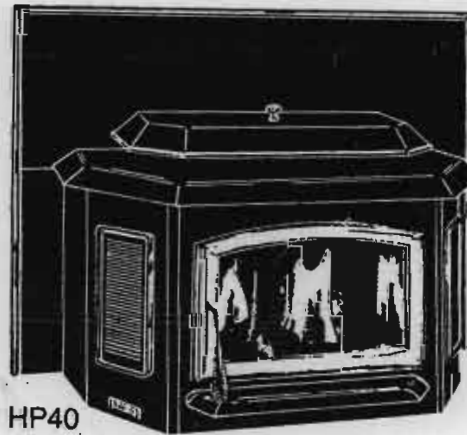
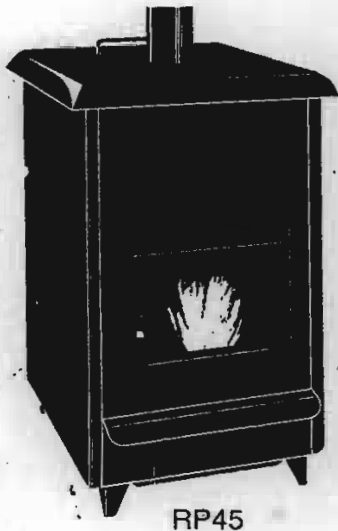
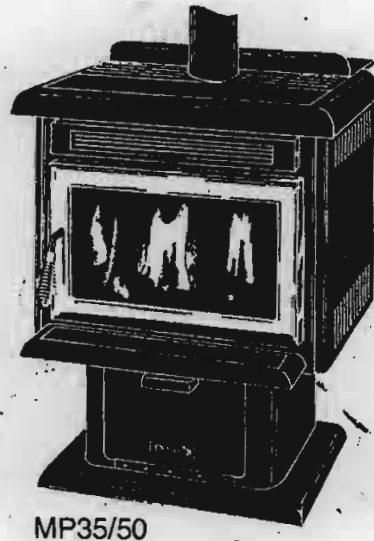
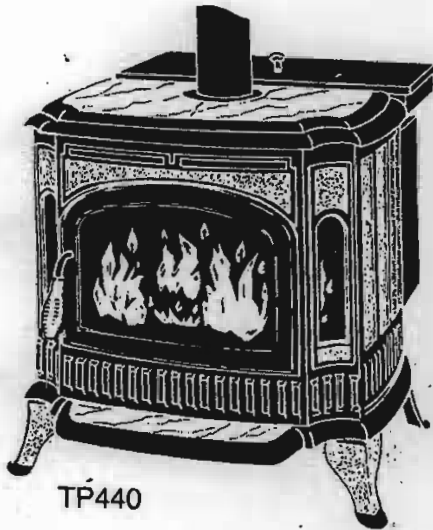

This Pellet Appliance Service Manual is intended for use by qualified service persons only.

TABLE OF CONTENTS

MP35/50

Specifications	1
Component Diagrams	2
Clearances	3
Maintenance	4-6

TP440

Specifications	7
Component Diagrams	8
Clearances	9
Maintenance	10-12

HP40

Specifications	13
Component Diagrams	14
Clearances	15
Maintenance	16-18

RP45

Specifications	19
Component Diagrams	20
Clearances	21
Installation	22-23
Maintenance	24-25

HOW IT WORKS	26-31
---------------------	-------

PRE-INSTALLATION	32
-------------------------	----

MAINTENANCE	33
--------------------	----

BURNING CORN	34-35
---------------------	-------

TOOLS/SUPPLIES/PARTS	36
-----------------------------	----

TROUBLE SHOOTING	37-41
-------------------------	-------

WIRING DIAGRAMS	42-43
------------------------	-------

WARRANTY	44-49
-----------------	-------

FLEXIBLE METAL HOSE	50
----------------------------	----

MODEL MP35/50

SPECIFICATIONS

Approx Sq Ft Heat Capacity	Up to 1800 Sq. Ft.
Flue Size	4" Top/Rear
Width	24"
Depth Overall	33"
Height Overall	33.5"
Height	31.75"
Floor to Rear Flue Center	17.5"
*L.H.Side of stove to cntr/flue.....	4.25"
Outside Air Provision	Yes
Floor Protection Requirements	
Mobile Home	Yes
Residential	** No
Fuse	3 amp
Hopper Capacity	55 lbs
Heat Input (Max.)	35,000-50,000 BTU/hr
Ship Weight	350 Lbs.
Room Blower	210 CFM 1.2 amps
Cup Motor	Approx. 1 RPM .34 amps
Auger Motor	Approx. 6 RPM 1.12 amps
Draft Fan	Approx. 60 CFM .65 amps

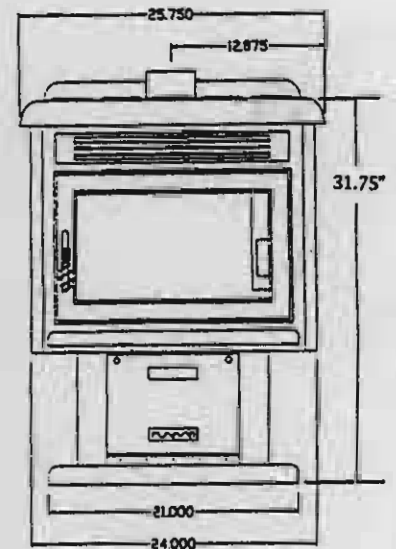
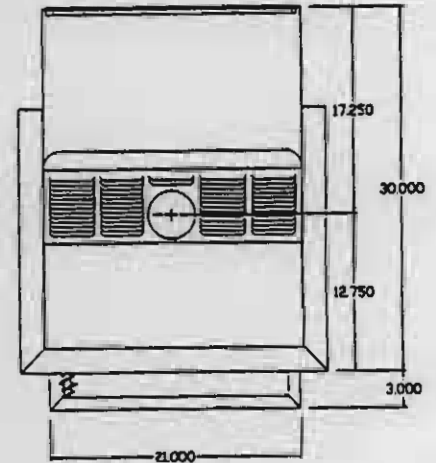

* Viewed from behind unit, facing forward.

** If installed on a solid level surface (no carpet).

~ Square feet heating capacities are approximations only. They will vary depending upon the level of insulation, climate, house design, ceiling height, ambient outside temperatures and how the stove is operated.

COMPONENT DIAGRAMS

Top Vent Outlet

Gold Door

Ash Drawer

Hopper

Rear Vent Outlet

Burner Manual Reset (15011)

Draft Fan (15001-1)

Safety Disc (11565)

Blower Manual Reset (15011)

Fan Speed Disc (15057)

Cup Motor (15060)

Auger Motor (15070)

Room Air Fan (16490)

(Shown with Motor Cabinet Removed)

Control Board (15023)

Rheostat (02082)

Motor Cabinet

Power Cord (02071)

CLEARANCES

The termination of the outside chimney of the pellet stove shall be located in accordance with the following:

1. Higher than 3 ft. above any forced air inlet (air conditioner, etc.) located within 10 ft.
2. Not less than 4 ft. below, 4 ft. horizontally from or 1 ft. above any gravity air inlet (door, window, etc.).
3. Not less than 2 ft. from an adjacent building and not less than 7 ft. above grade when located adjacent to the public sidewalks (access).
4. Not less than 3 ft. below an eave or any construction that projects more than 2" from the plane of the wall.

Note: Do not use class B venting intended for gas appliances as a chimney or connector pipe on a pellet fired unit.

Minimum Clearances to Combustibles

Side: 12"
 Back: 1"
 Front: 48" horizontal from door

Single Wall pipe: 9"
 Maximum horizontal run: 36"
 Offsets allowed: 2

Alcove Clearances *

The MP35/50 pellet stove may be installed in an alcove with the following minimum clearances:

Alcove height: 72"
 Side Wall Clearance: 12"
 Back Wall Clearance: 1"

The stove cannot be recessed into the alcove more than 6" from the face of the stove to the plane of the opening of the alcove.

Floor Protection

If placing units on a combustible surface, the following requirements must be met:

Residential Installation: No floor protection required when installed on a solid level surface (no carpet).

Mobile Home Installations: The floor protection must cover the area beneath the stove and extend one inch beyond the base on all sides.

Corner

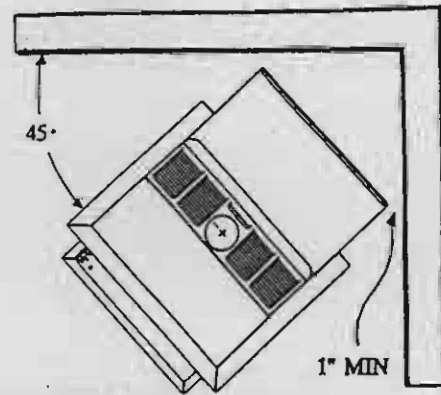

Rear Wall or Alcove

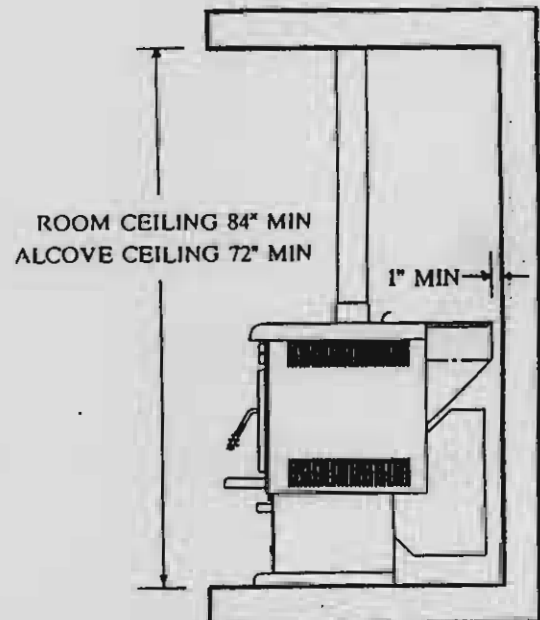
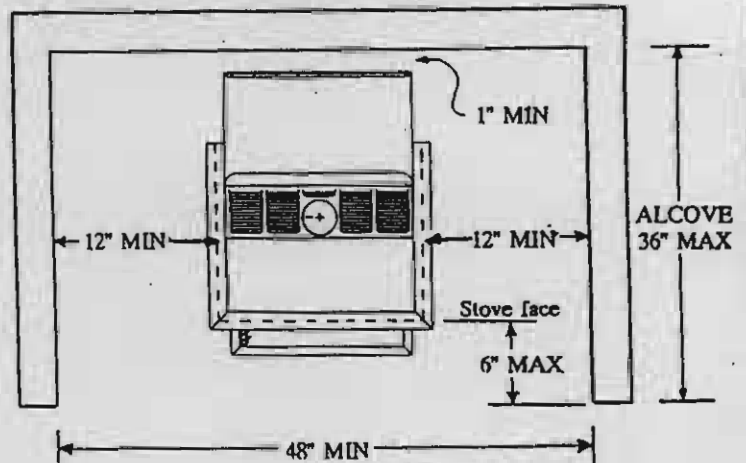

*** IF INSTALLED TO THE MINIMUM SIDE AND REAR CLEARANCES IN AN ALCOVE, REMOVAL OF THE APPLIANCE MAY BE NECESSARY FOR SERVICING.**

MAINTENANCE

Firepot

Keep the Firepot inner holes free of obstructions (buildup). Pull the Firepot and empty it when this occurs. The quality and quantity of pellets used will dictate the necessary cleaning. Remove clinkers or carbon build up.

Clinkers are a byproduct of the fuel. Silica (or dirt) in the fuel, along with other impurities can fuse under heat and cause clinkering. Clinkering is a function of the fuel, not the stove. A clinker should be removed using a clean out tool.

Refractory Logs

The following steps will insure the longevity of your logs:

1. Never attempt to handle them while they are hot.
2. Use a "Natural Fire" Firepot cleaner tool (Part #1000) to remove ashes from the Firepot. In many cases you can do this without removing any logs.
Except when cleaning out the bottom of the stove, do not remove the large 1/4 Logs.

Cleaning the MP35/50

1. Turn the unit off two to three hours before cleaning to allow the unit to cool (see Shut Down Procedure).
2. Place protective floor covering around the front of the stove.
3. CAREFULLY remove the decorative logs from the Firebox and set them aside.
4. Remove the Firepot by removing screw(s) from the auger housing and pulling up and out.

5. Remove Ash Drawer and empty ashes into your noncombustible container. Dispose of ashes as previously described (see Ash Removal and Disposal). Clean any remaining ash from the Firebox and Ash Drawer area.
6. After the stove chimney has been swept, the top/rear chimney seal off plate needs to be pulled off of the stove to vacuum the unit out. There is a Baffle Plate beneath the Heat Exchange Tubes. Fly ash will accumulate on this plate and must be removed to ensure full efficiency. To clean, Remove the Baffle Plate and pull the cleaner plate all the way forward and then return to the rear of the firebox.
7. Remove the Clean Out Access cover and vacuum out the fly ash (see page 10).
8. Reinstall your Firepot being sure that the Auger Tube protrudes about 1/8" into the Firepot. Replace baffle and clean out access. Reseal and secure stove chimney.
9. The cleaning frequency will be dictated by the quality and quantity of the fuel burned. The following is the suggested schedule to establish a minimum: After every 1/2 ton of pellets, when the metal surfaces of the exchange tubes are no longer visible, or after every 2-3 weeks of use.

MAINTENANCE

Ash Removal and Disposal

CAUTION: BE SURE THE FIRE IS OUT AND STOVE IS COLD BEFORE REMOVING ASHES! NEVER BURN YOUR STOVE WITH THE ASH DRAWER OPEN.

Ashes can hold live embers for several days, and must be disposed of with care. Be certain the fire is out before you remove the Ash Drawer. Brush ashes into the Ash Drawer. After emptying, clean and replace the Ash Drawer and tighten the spring loaded screws. NEVER place ashes in a cardboard box or any other combustible receptacle. Place the ashes in a metal container with a tight fitting metal lid. The closed container should be stored on a noncombustible surface, away from combustible materials. Keep the ashes in the closed container until you are certain all the cinders have completely cooled. Replace Ash Drawer Gasket if it becomes damaged.

Door Gasket

A spun fiberglass gasket (3/4" in diameter) provides the seal around the fuel door. Should this become frayed or damaged it should be replaced. Spun fiberglass "rope" gasketing can be purchased from your dealer or some hardware stores. It must be the same diameter as the original. Use high temperature (RTV) silicone sealer as an adhesive.

WARNING: MAINTAIN THE DOOR SEAL IN GOOD CONDITION. DO NOT LEAVE THE STOVE BURNING WITH THE DOOR OPEN OR AJAR. DO NOT USE ANY TYPE OF ABRASIVE CLEANER OR POLISH ON GOLD PLATING.

Creosote Formation and Need for Removal

If your stove is properly adjusted, very little creosote will develop in your flue system. If creosote begins to develop, it is likely that poor adjustment or needed maintenance is causing incomplete combustion of the fuel. Be sure your Draft Fan switch, and Draft Fan shutter are set properly.

What causes creosote is the moisture content of fuel versus the rate at which it is burned. Piloting a stove on low feed rate for long periods of time, causes incomplete combustion, creating vapors which may condense in a relatively cool chimney, thus forming creosote. These deposits tend to form in long runs of venting where gases cool prior to exhausting.

Soft fly ash is a normal by product of burning pellet fuel, and can accumulate in your flue system. Using lower grade fuel will increase the frequency of cleaning that will be needed. Check your flue regularly (at least once a month) until a schedule can be established for your installation and fuel quality. Remember, during high use periods to increase your inspection cycle.

Note: Single wall pipe cools rapidly, therefore installations using this type of flue are more susceptible to creosote deposits.

Paint

Your stove finish is a high temp paint that requires time and temperature to completely cure. Depending on your use, this may take a few hours or a few days. Do not attempt to repaint the stove until the paint is completely cured. Do not place anything on the stove surface until the stove has gone through several heat up/cool down cycles, as the paint will become soft before it cures.

Fan(s)

At least once each year, check the Room Air Fan and Draft Fan inlets for deposits from carpeting, pet hair, furniture coverings, etc. Use a brush and/or light vacuuming for cleaning.

MAINTENANCE

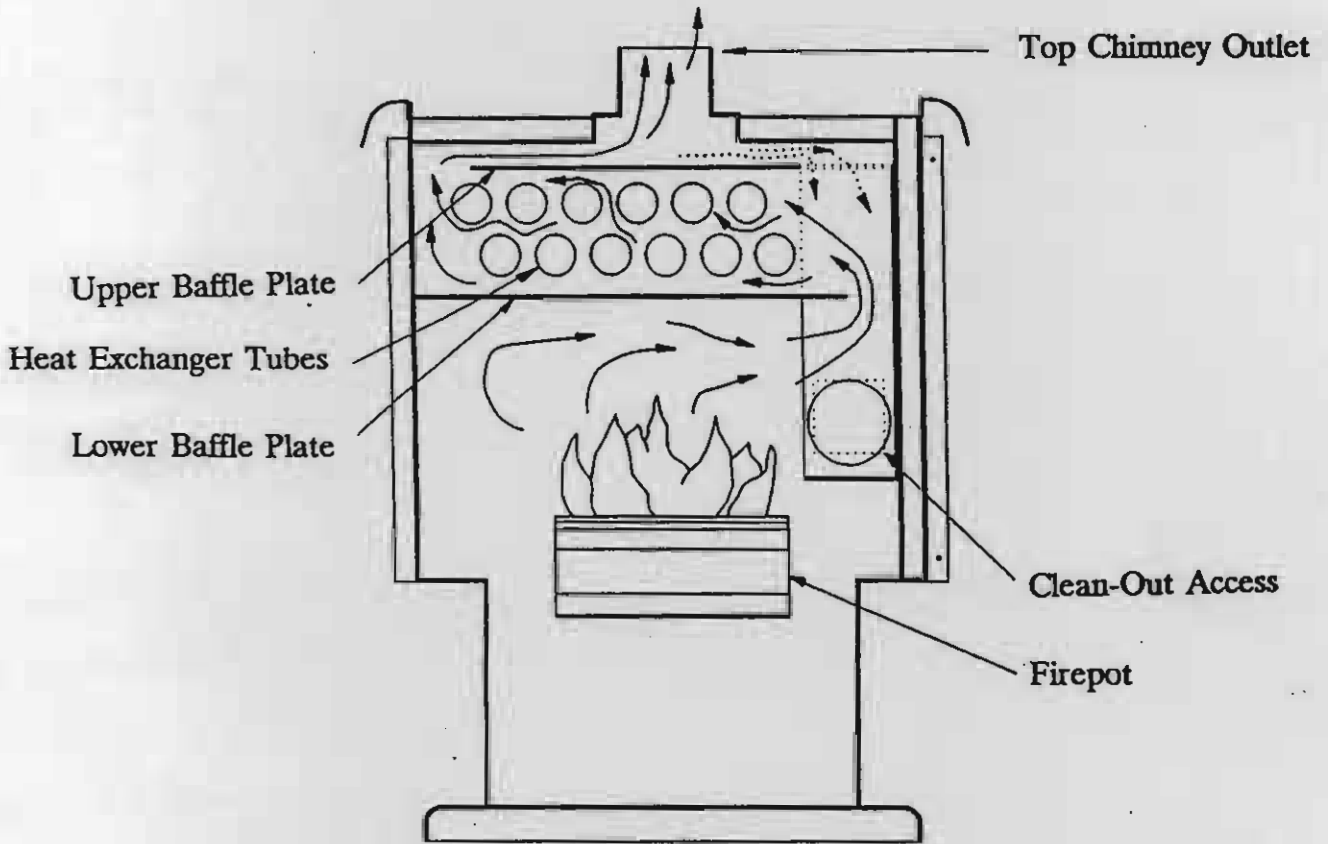

MODEL TP440

SPECIFICATIONS

Approx Sq Ft Heat Capacity	Up to 1500 Sq. Ft.
Flue size	4" Top/Rear
Width	27"
Depth Overall	34"
Height Overall	27.5"
Bk/Hopper Cntr of Flue	20"
Floor to Rear Flue Center	10"
Outside Air Provislon	Yes
Floor Protection Requirements	
Mobile Home	Yes
Residential	* No
Fuse	3 amp
Hopper Capacity	35 lbs
Heat Input (maximum)	40,000 BTU/hr
Ship Weight	400 Lbs.
Room Blower	160 CFM .9 amps
Cup Motor	Approx. 1 RPM .34 amps
Auger Motor	Approx. 6 RPM 1.12 amps
Draft Fan	Approx. 60 CFM .65 amps

* If installed on a solid level surface (no carpet)

~ Square feet heating capacities are approximations only. They will vary depending upon the level of insulation, climate, house design, ceiling height, ambient outside temperatures and how the stove is operated.

COMPONENT DIAGRAMS

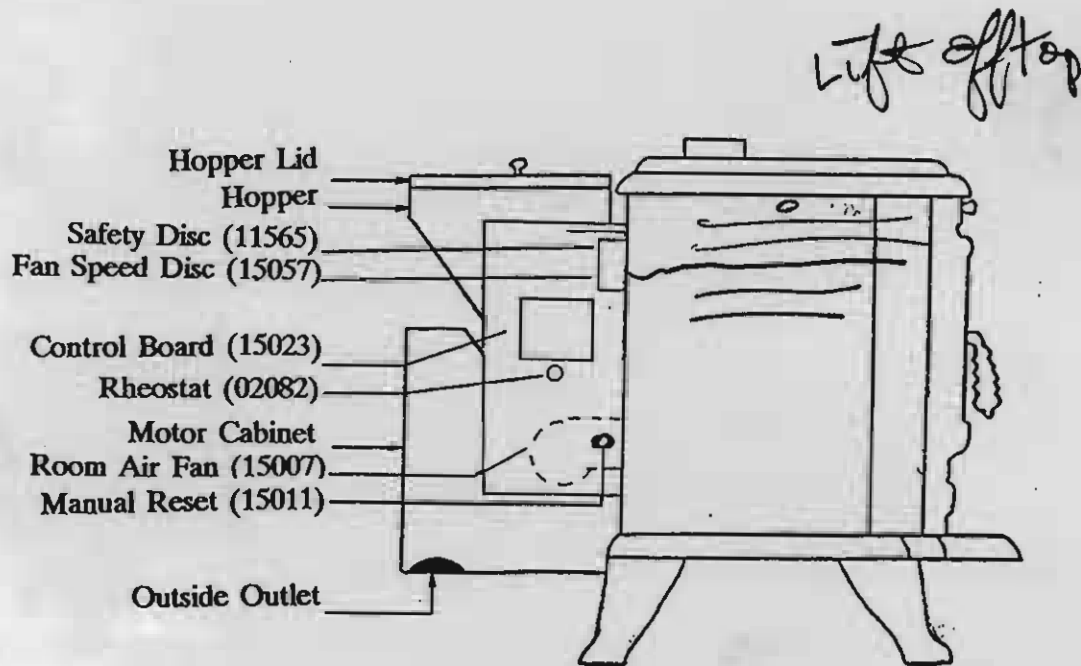
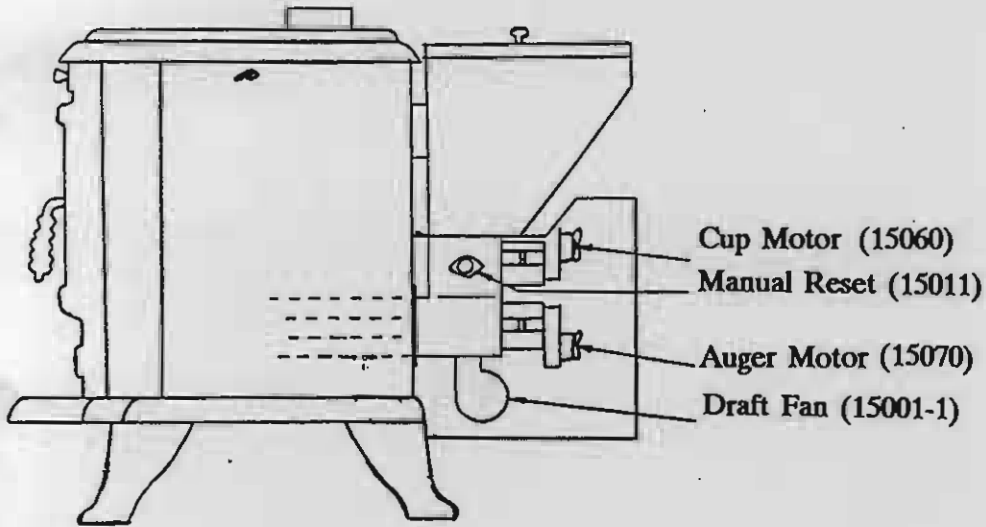

CLEARANCES

The termination of the outside chimney of the pellet stove shall be located in accordance with the following:

1. Higher than 3 ft. above any forced air inlet (air conditioner, etc.) located within 10 ft.
2. Not less than 4 ft. below, 4 ft. horizontally from or 1 ft. above any gravity air inlet (door, window, etc.).
3. Not less than 2 ft. from an adjacent building and not less than 7 ft. above grade when located adjacent to the public sidewalks (access).
4. Not less than 3 ft. below an eave or any construction that projects more than 2" from the plane of the wall.

Note: Do not use class B venting intended for gas appliances as a chimney or connector pipe on a pellet fired unit.

Minimum Clearances to Combustibles

Side: 12"
 Back: 1"
 Front: 48" horizontal from door

Single Wall pipe: 9"
 Maximum horizontal run: 36"
 Offsets allowed: 2

Alcove Clearances *

The TP440 pellet stove may be installed in an alcove with the following minimum clearances:

Alcove height: 72"
 Side Wall Clearance: 12"
 Back Wall Clearance: 1"

The stove cannot be recessed into the alcove more than 6" from the face of the stove to the plane of the opening of the alcove.

Floor Protection

If placing units on a combustible surface, the following requirements must be met:

Residential Installation: No floor protection required when installed on a solid level surface (no carpet).

Mobile Home Installations: The floor protection must cover the area beneath the stove and extend one inch beyond the base on all sides.

Corner

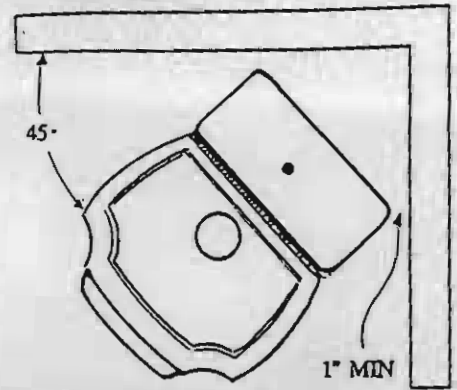

Rear Wall or Alcove

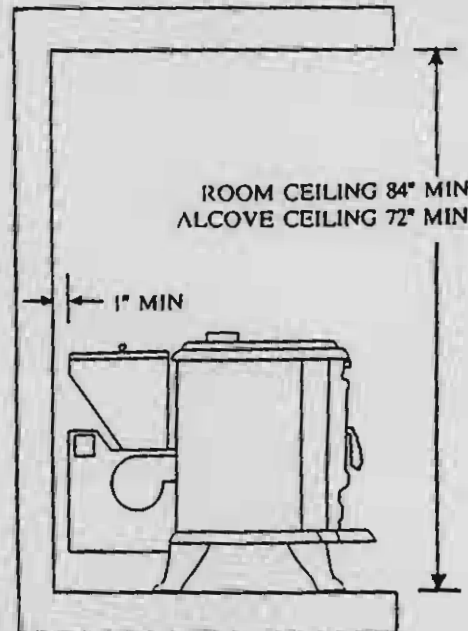
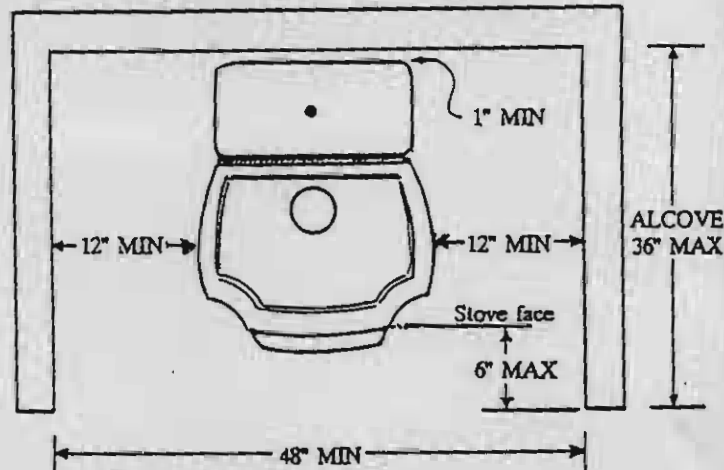

*** IF INSTALLED TO THE MINIMUM SIDE AND REAR CLEARANCES IN AN ALCOVE, REMOVAL OF THE APPLIANCE MAY BE NECESSARY FOR SERVICING.**

MAINTENANCE

Firepot

removes with 2 bolts or pins

Keep the Firepot inner holes free of obstructions (buildup). Pull the Firepot and empty it when this occurs. The quality and quantity of pellets used will dictate the necessary cleaning. Remove clinkers or carbon buildup.

Clinkers are a byproduct of the fuel. Silica (or dirt) in the fuel, along with other impurities can fuse under heat and cause clinkering. Clinkering is a function of the fuel, not the stove. A clinker should be removed using a clean out tool.

Refractory Logs

The following steps will insure the longevity of your logs:

1. Never attempt to handle them while they are hot.
2. Use a "Natural Fire" Firepot cleaner tool (Part #1000) to remove ashes from the Firepot. In many cases you can do this without removing any logs. Except when cleaning out the bottom of the stove, do not remove the large 1/4 Logs.

Cleaning the TP440

1. Turn the unit off two to three hours before cleaning to allow the unit to cool (see Shut Down procedure).
2. Place protective floor covering around the front of the stove.
3. CAREFULLY remove the decorative logs from the Firebox and set them aside.
4. Remove the Firepot by removing screw(s) from the auger housing and pulling up and out.

5. Remove the ashes and empty into your noncombustible container. Dispose of ashes as previously described (see ash removal and disposal). Clean any remaining ash from the Firebox area.
6. After the stove chimney has been swept, remove the rear chimney seal off plate (if top vented), or the top chimney seal off plate (if rear vented). Vacuum the unit out, through the opening.
7. Between the top of the Heat Exchange Tubes and the top of the stove there is a baffle plate (see page 10). Fly ash will accumulate on this plate and must be removed or your flue will become clogged. You can use a small diameter hose down through the top vent outlet or remove the (2) 13 millimeter bolts on either side of the top, and pull the top. Be sure to regasket the top before you reinstall it.
8. Remove the dust and fly ash which accumulates on the Heat Exchange Tubes.
9. Reinstall your Firepot being sure that the Auger Tube protrudes about 1/8" into the Firepot. Reseal and secure stove chimney.
10. The cleaning frequency will be dictated by the quality and quantity of the fuel burned. The following is the suggested schedule to establish a minimum: After every 1/2 ton of pellets, when the metal surfaces of the exchange tubes are no longer visible, after every 2-3 weeks of use.

MAINTENANCE

Ash Removal and Disposal

CAUTION: BE SURE THE FIRE IS OUT AND STOVE IS COLD BEFORE REMOVING ASHES! NEVER BURN YOUR STOVE WITH THE DOOR OPEN.

Ashes can hold live embers for several days, and must be disposed of with care. NEVER place ashes in a cardboard box or any other combustible receptacle. Place the ashes in a metal container with a tight fitting metal lid. The closed container should be stored on a noncombustible surface, away from combustible materials. Keep the ashes in the closed container until you are certain all the cinders have completely cooled.

Door Gasket

A spun fiberglass gasket (3/4" in diameter) provides the seal around the fuel door. Should this become frayed or damaged it should be replaced. Spun fiberglass "rope" gasket can be purchased from your dealer or some hardware stores. It must be the same diameter as the original. Use high temperature (RTV) silicone sealer as an adhesive.

WARNING: MAINTAIN THE DOOR SEAL IN GOOD CONDITION. DO NOT LEAVE THE STOVE BURNING WITH THE DOOR OPEN OR AJAR.

Fan(s)

At least once each year, check the Room Air and Draft Fans inlets for deposits from carpeting, pet hair, furniture coverings, etc. Use a brush and/or light vacuuming for cleaning. Oiling the fans is not necessary.

Creosote Formation and Need for Removal

If your stove is properly adjusted, very little creosote will develop in your flue system. If creosote begins to develop, it is likely that poor adjustment or needed maintenance is causing incomplete combustion of the fuel. Be sure your Draft Fan Switch, and Draft Fan shutter are set properly.

What causes creosote is the moisture content of the fuel versus the rate at which it is burned. Piloting a stove on low feed rate for long periods of time, causes incomplete combustion, creating vapors which may condense in a relatively cool chimney, thus forming creosote. Also, creosote deposits tend to form in long runs of venting where gases cool prior to exhausting.

Soft fly ash is a normal by product of burning pellet fuel, and can accumulate in your flue system. Using lower grade fuel will increase the frequency of cleaning that will be needed. Check your flue regularly (at least once a month) until a schedule can be established for your installation and fuel quality. Remember, during high use periods to increase your inspection cycle.

Note: Single wall pipe cools rapidly, therefore installations using this type of flue are more susceptible to creosote deposits.

Paint

Your stove finish is a high temp paint that requires time and temperature to completely cure. Depending on your use, this may take a few hours or a few days. Do not attempt to repaint the stove until the paint is completely cured. Do not place anything on the stove surface until the stove has gone through several heat up/cool down cycles, as the paint will become soft before it cures.

MAINTENANCE

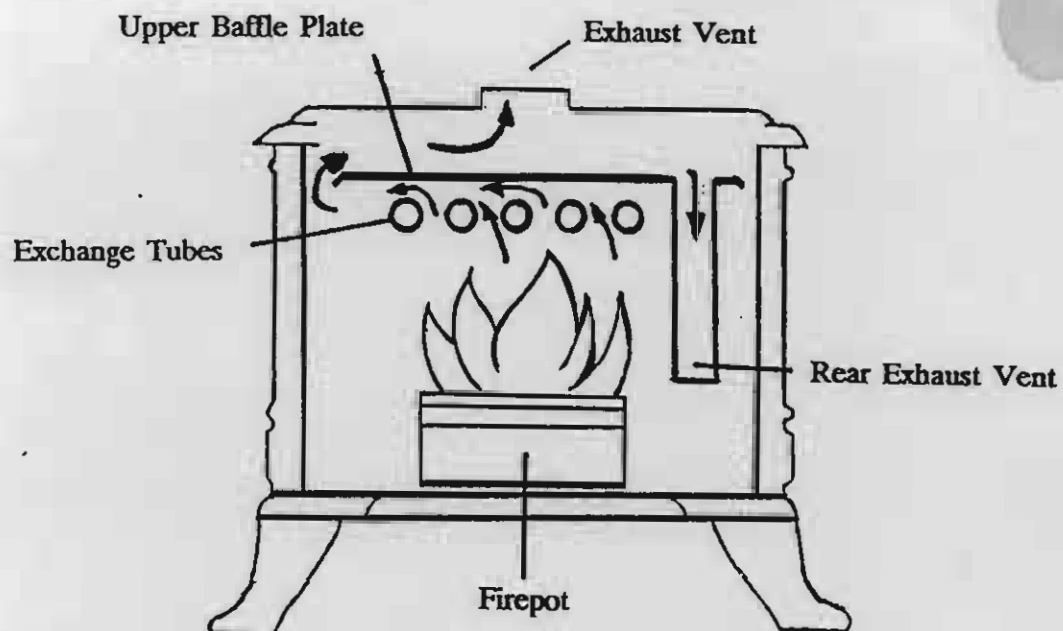

MODEL HP40

SPECIFICATIONS

Approx Sq. Ft. Heat Capacity	Up to ~ 1500 Sq. Ft.
Flue Size	4" Top Breach
Width Overall	42"
Depth Overall	35"
Height Overall	32"
Width	31 1/2"
Recessed area Height	19 3/4"
Width	27"
Depth	16 1/2"
Outside Air Provision	Yes
Fuse	3 amp
Hopper Capacity	35 lbs.
Heat Input (Max.)	40,000 BTU/hr
Ship Weight	350 lbs.
Room Blower (2 ea.)	160 CFM (ea) .9 amps
Cup Motor	♦ 1 RPM .34 amps
Auger Motor	♦ 6 RPM 1.12 amps
Draft Fan	♦ 60 RPM .65 amps

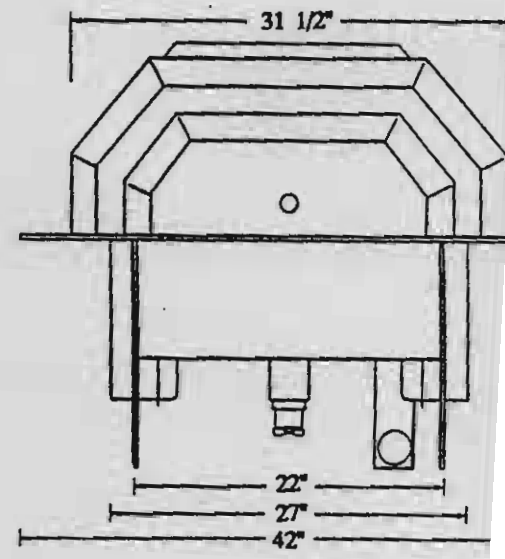
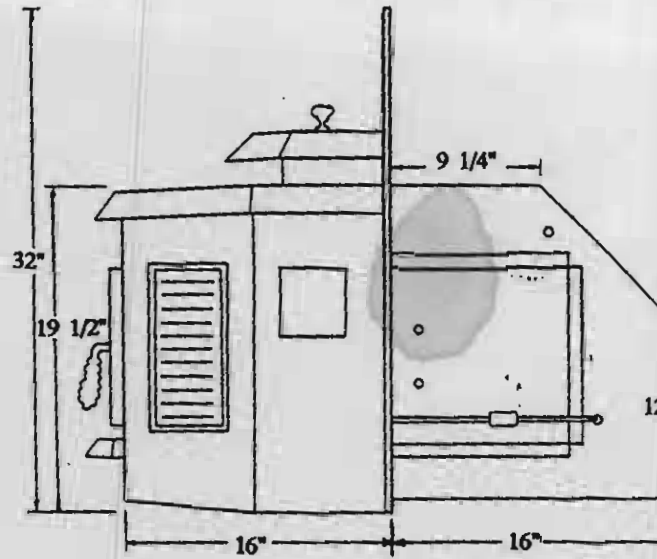

- ♦ RPM specifications are approximations only.
- Square feet heating capacities are approximations only. They will vary depending upon the level of insulation, climate, house design, ceiling height, ambient outside temperatures and how the stove is operated.

COMPONENT DIAGRAMS

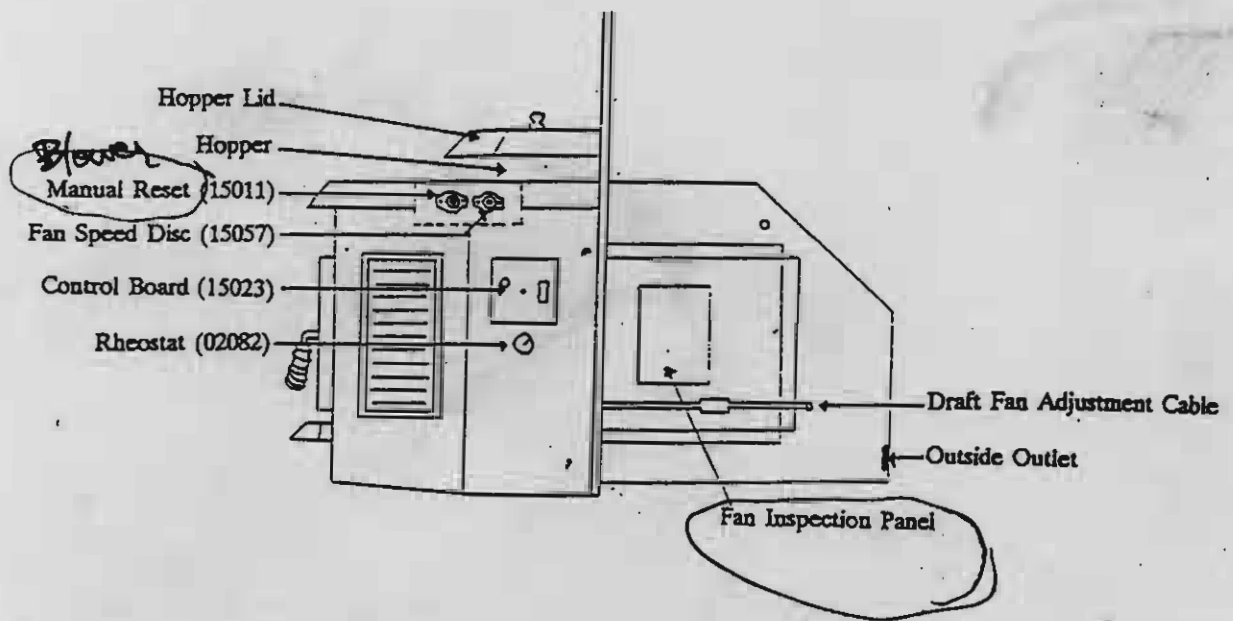
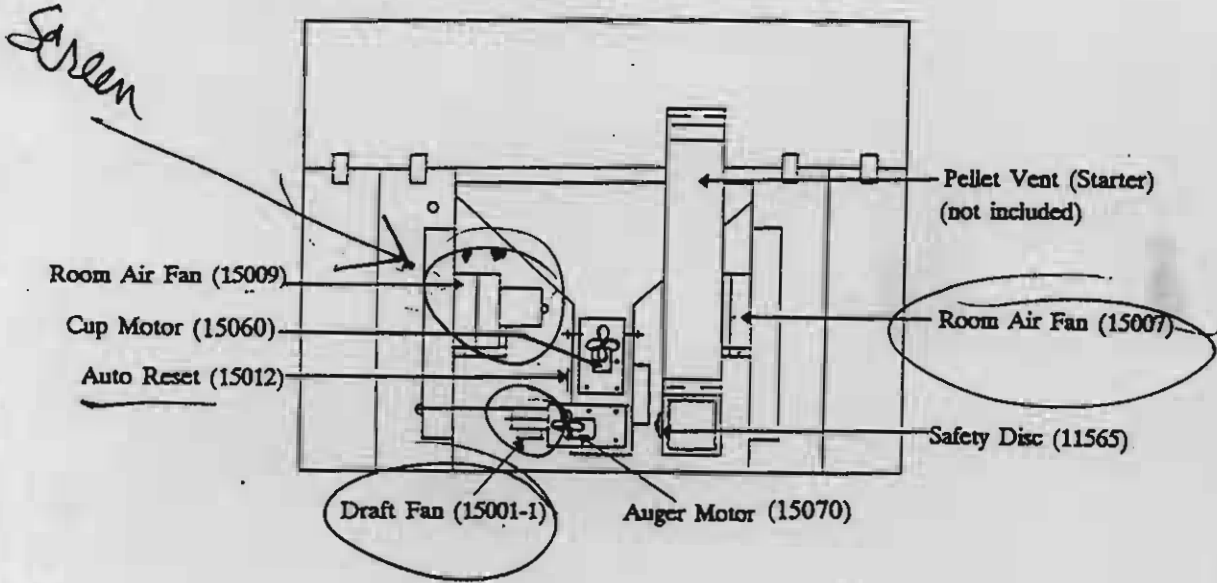

CLEARANCES

The termination of the outside chimney of the pellet insert shall be located in accordance with the following:

1. Higher than 3 ft. above any forced air inlet (air conditioner, etc.) located within 10 ft.
2. Not less than 4 ft. below, 4 ft. horizontally from or 1 ft. above any gravity air inlet (door, window, etc.).
3. Not less than 2 ft. from an adjacent building and not less than 7 ft. above grade when located adjacent to the public sidewalks (access).
4. Not less than 3 ft. below eaves or any construction that projects more than 2" from the plane of the wall.

Notes:

1. Do not use class B venting intended for gas appliances as a chimney or connector pipe on a pellet fired unit.
2. Maximum Of Two Offsets Permitted

Masonry & Into A Zero Clearance Fireplace

D	Insert to sidewall	14"
E	Insert to side trim	2"
F	Insert to mantel	16"
G	Insert to top trim	11"
H	Hearth extension	0"
I	Rear Shroud to Comb.	0"

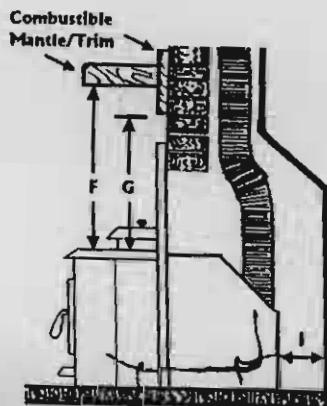
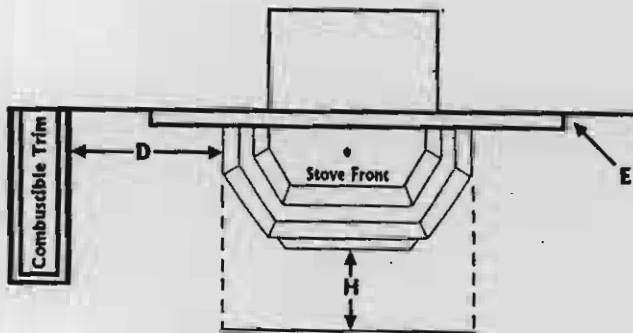

Installed As A Zero Clearance

A	Insert to framing	0"
B	Pellet Vent to framing	3"
C	Pellet Vent to framing	3"
D	Insert to sidewall	14"
E	Insert to side trim	2"
F	Insert to mantel	16"
G	Insert to top trim	11"
H	Hearth extension	0"

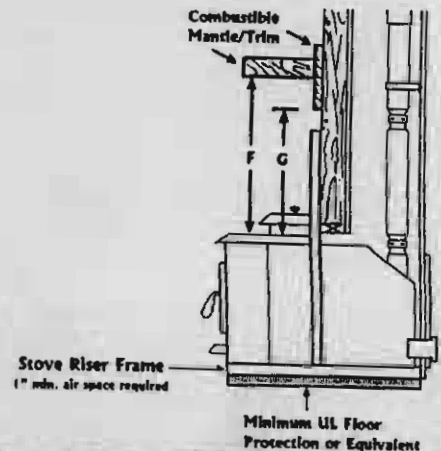
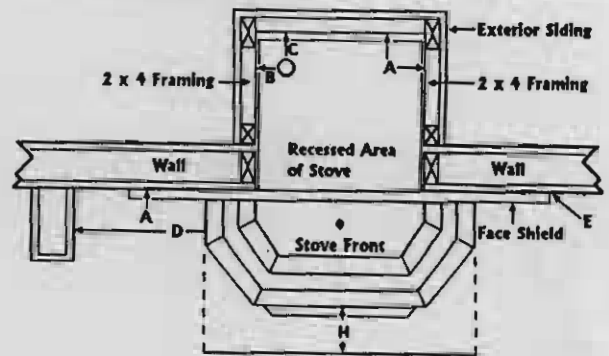

MAINTENANCE

Firepot

Keep the Firepot inner holes free of obstructions (buildup). Remove Firepot and empty it when this occurs. The quality and quantity of pellets used will dictate the necessary cleaning. Remove clinkers or carbon build up.

Clinkers are a by-product of the fuel. Silica (or dirt) in the fuel, along with other impurities can fuse under heat and cause clinkering. Clinkering is a function of the fuel, not the insert. A clinker should be removed using a clean out tool.

Refractory Logs

The following steps will insure the longevity of your logs:

1. Never attempt to handle them while they are hot.
2. Use a "NaturalFire™" Firepot cleaner tool (Part # 1000) to remove ashes from the Firepot. In many cases you can do this without removing any logs. Except when cleaning out the bottom of the insert, do not remove the large 1/4 Logs.

Cleaning the HP40

1. Turn the unit off two to three hours before cleaning to allow the unit to cool (see Shut Down Procedure).
2. Place protective floor covering around the front of the insert.
3. **CAREFULLY** remove the decorative logs from the Firebox and set them aside. Remove the Baffle Plate.

4. Remove the Firepot by removing screws from the auger housing and pulling up and out. Back out bolt on Clean Out Access Plate and remove.
5. Empty ashes into your noncombustible container. Dispose of ashes as previously described (see Ash Removal and Disposal). Clean any remaining ash from the Firebox area.
6. After the stove chimney has been swept, the rear chimney needs to be pulled off of the insert to vacuum the unit out. Inside the firebox on the left hand side of the insert is the flue outlet. It has a vertical run then takes a 90° turn and on to a horizontal run. This is where it connects to the vent outlet. This section needs to be vacuumed out.
7. Remove the dust and fly ash, with a brush, which accumulates on the Heat Exchange Tubes.
8. Reinstall your Firepot being sure that the Auger Tube protrudes about 1/8" into the Firepot. Replace baffle and clean out access. Reseal and secure stove chimney.
9. The cleaning frequency will be dictated by the quality and quantity of the fuel burned. the following is the suggested schedule to establish a minimum: after every 1/2 ton of pellets, when the metal surfaces of the exchange tubes are no longer visible, or after every 2-3 weeks of use.

Reanger for

MAINTENANCE

Ash Removal and Disposal

CAUTION: BE SURE THE FIRE IS OUT AND INSERT IS COLD BEFORE REMOVING ASHES.

Ashes can hold live embers for several days, and must be disposed of with care. Be certain the fire is out before you remove the ashes. Never place ashes in a cardboard box or any other combustible receptacle. Place the ashes in a metal container with a tight fitting metal lid. The closed container should be stored on a noncombustible surface, away from combustible materials. Keep the ashes in the closed container until you are certain all cinders have completely cooled.

Door Gasket

A spun fiberglass gasket (3/4" in diameter) provides the seal around the fuel door. Should this become frayed or damaged it should be replaced. Spun fiberglass "rope" gasketing can be purchased from an authorized Earth Stove dealer or some hardware stores. It must be the same type and diameter as the original. Use high temperature (RTV) silicone sealer as an adhesive.

WARNING: MAINTAIN THE DOOR SEAL IN GOOD CONDITION. DO NOT LEAVE THE INSERT BURNING WITH THE DOOR OPEN OR AJAR. DO NOT USE ANY TYPE OF ABRASIVE CLEANER OR POLISH ON GOLD PLATING.

Fan(s)

At least once each year, check the Room Air fans and Draft Fan inlets for deposits from carpeting, pet hair, furniture coverings, etc. Use a brush and/or light vacuuming for cleaning. Oiling the fans is not necessary.

Creosote Formation and Need for Removal

If your insert is properly adjusted, very little creosote will develop in your flue system. If creosote begins to develop, it is likely that poor adjustment or needed maintenance is causing incomplete combustion of the fuel. Be sure your Draft Fan Switch, and Draft Fan shutter are set properly.

What causes creosote is the moisture content of the fuel in relation to the rate at which it is burned. Burning a stove on a low feed rate for long periods of time, causes incomplete combustion, this creates vapors which may condense in a relatively cool chimney, forming creosote. Creosote deposits tend to form in long runs of venting where gases cool prior to exhausting.

Soft fly ash is a normal by-product of burning pellet fuel, and can accumulate in your flue system. Using lower grade fuel will increase the frequency of cleaning that will be needed. Check your flue regularly (at least once a month) until a schedule can be established for your installation and fuel quality. Remember, during high use periods to increase your inspection cycle.

Note: Single wall pipe cools rapidly and is therefore more susceptible to creosote deposits.

Paint

Your insert finish is a high temperature paint that requires time and temperature to completely cure. Depending on your use, this may take a few hours or a few days. Do not attempt to repaint the insert until the paint is completely cured. Do not place anything on the insert surface until the insert has gone through several heat up/cool down cycles, as the paint will become soft before it cures.

MAINTENANCE

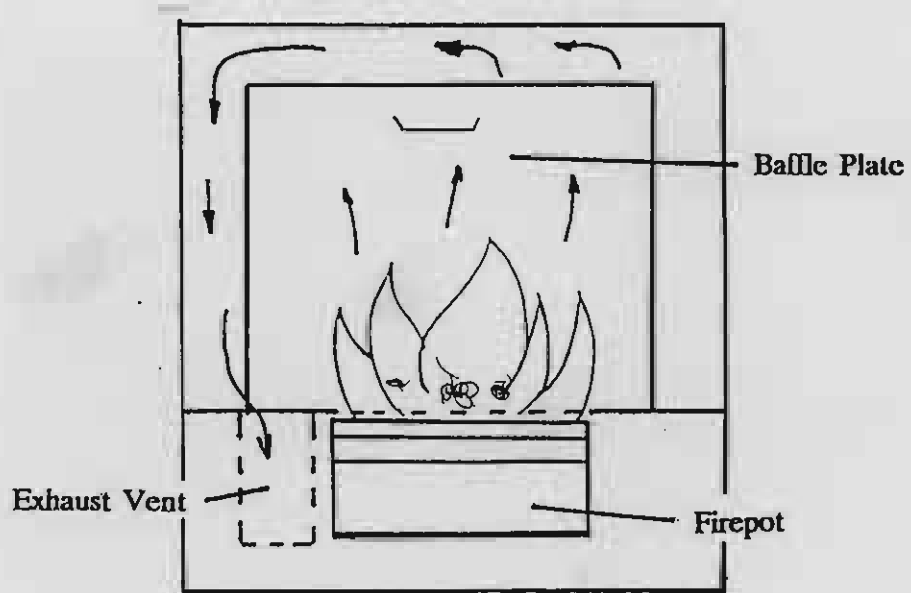
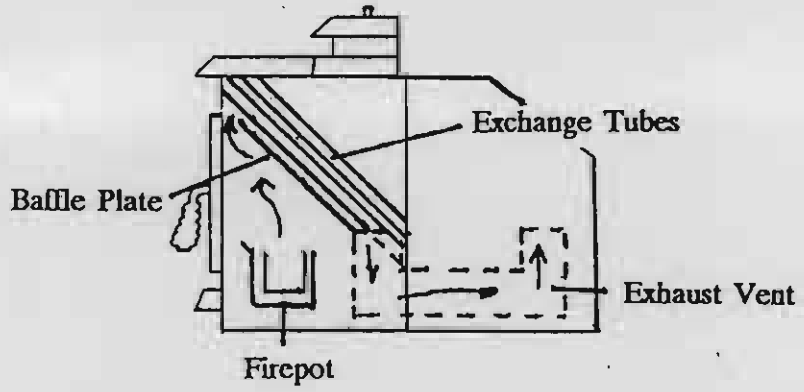

MODEL RP45

SPECIFICATIONS

Approx Sq Ft Heat Capacity* Up to 1600 Sq. Ft.
Flue Size 4" Top
Width 22"
Depth Overall 26 1/2"
Height Overall 35"
Floor to Flue 37"
Outside Air Provision Yes
Floor Protection Requirement Yes
Hopper Capacity 40 lbs
Fuel Input (Max.) 45,000 BTU/hr
Ship Weight 210 Lbs.
Room Blower (Optional) 160 CFM .9 amps
Cup Motor Approx. 1.2 RPM .34 amps

* Square foot heating capacities are approximations only. They will vary depending upon the level of insulation, climate, house design, ceiling height, ambient outside temperatures and how the stove is operated.

COMPONENT DIAGRAMS

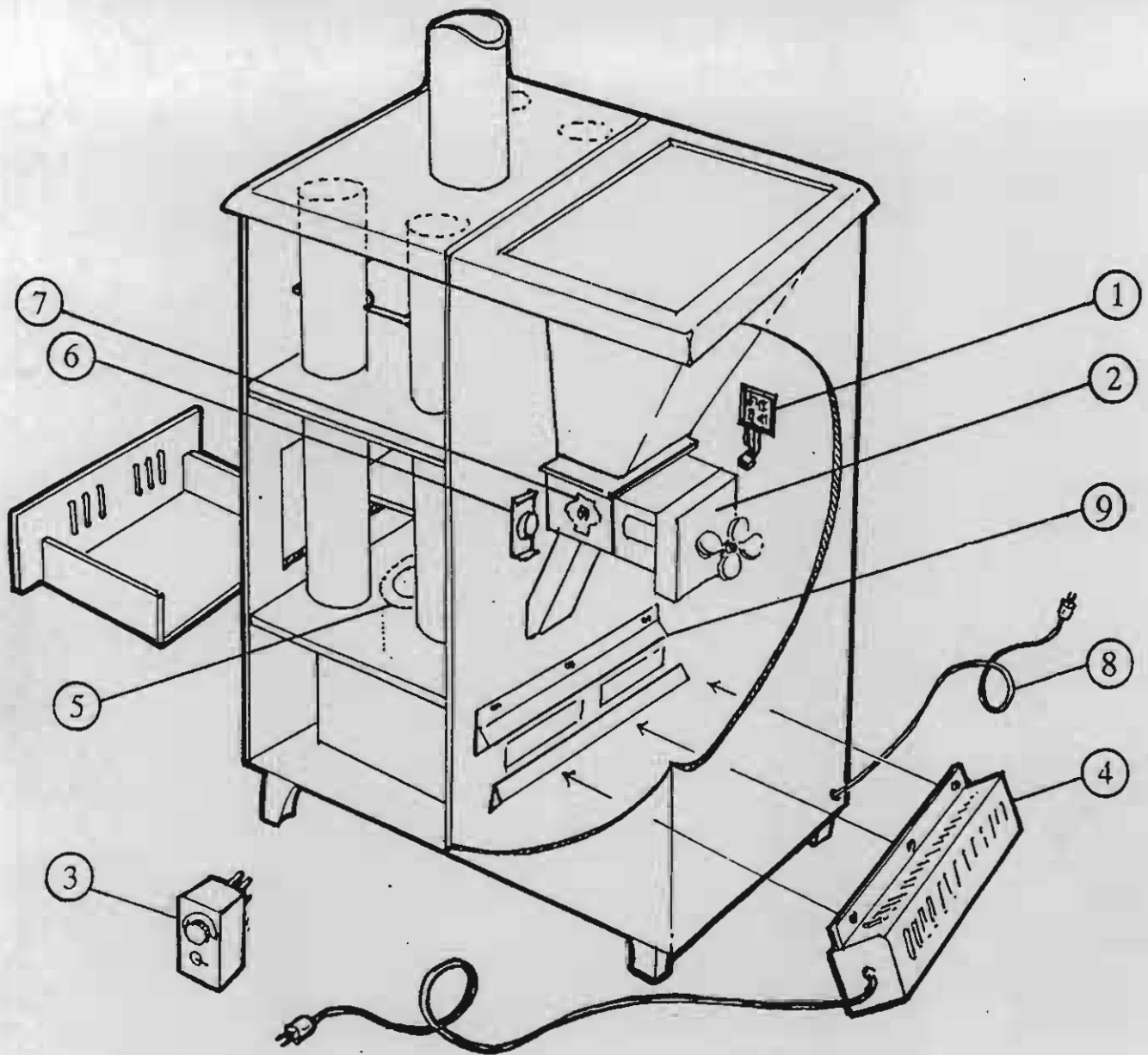

Item	Part #	Description	Item	Part #	Description
1	18470	Fuel Rate Switch	5	18401	Firepot
2	15071	Cup Motor	6	11565	Safety Disc
3	14440	Dial-A-Temp	7	15011	Burner Manual Reset
4	18150	* Optional Blower Kit (Includes Dial-A-Temp)	8	02071	Power Cord
			9	18475	Optional Fan Bracket

* Requires Optional Fan Bracket (item #9) for mounting.

CLEARANCES

Floor Protection

If placing units on a combustible surface, the floor protection must cover the area beneath the stove and extend one inch beyond the base on all sides.

Minimum Clearances to Combustibles

Side: 6"
Back: 1"
Front: 16" in front of the unit

Note: Although the approved clearance to combustibles is less, manufacturer suggests you maintain 12" clearance for ease of maintenance and serviceability, if possible.

Installation dimensions are to the flue centerline, not to the outside of flue collar as shown on the safety label.

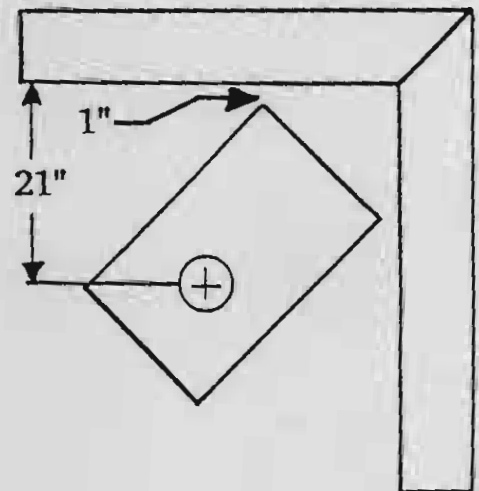
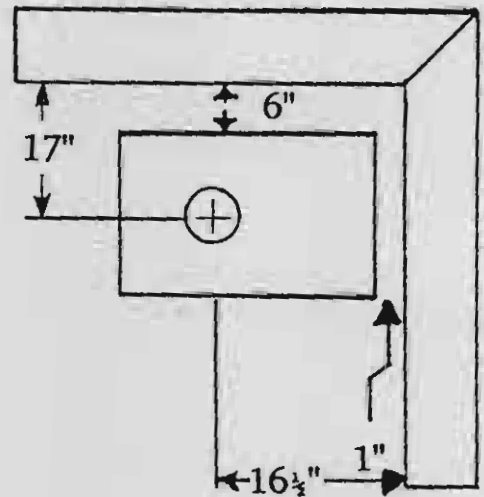

Note: Do not use class B venting intended for gas appliances as a chimney or connector pipe on a pellet fired unit.

INSTALLATION

Venting Requirements

Refer to clearances before installing your stove.

Because the RP45 is a natural draft system, it requires an adequate vertical flue system to ensure proper operation. A minimum of 12' of vertical rise from the top of the appliance is required. Up to (2) 45° offsets can be used, ending in vertical termination. An additional 24" of flue height should be added for each offset to insure adequate draft.

Connect only one flue per appliance. When passing through walls or ceilings, the manufacturer recommends that clearances are maintained in accordance with NFPA 211 which is normally included in the pipe manufacturer specifications. Do not downsize your connecting pipe or chimney.

Your Natural Draft RP45 pellet stove must be connected to a 4" vent pipe only. The preferred type of pipe is a listed chimney which conforms to UL standard 641 or a single wall pipe, 26 gauge minimum. Single wall connector pipe is limited to use within the room of installation; wall or ceiling penetration must be with a listed vent pipe (4" Pellet Vent). Follow the pipe manufacturers installation instructions and clearances. All pipe joints must be sealed with the compound supplied with the pipe or a RTV silicone with a rating of at least 570°F.

You may connect the single wall or pellet vent to the top of the stove using three screws to secure it to the collar. Use a RTV silicone with a rating of at least 570°F, or 3M INTERAM to provide a complete seal of the flue pipe to the stove.

STANDARD (RECOMMENDED)

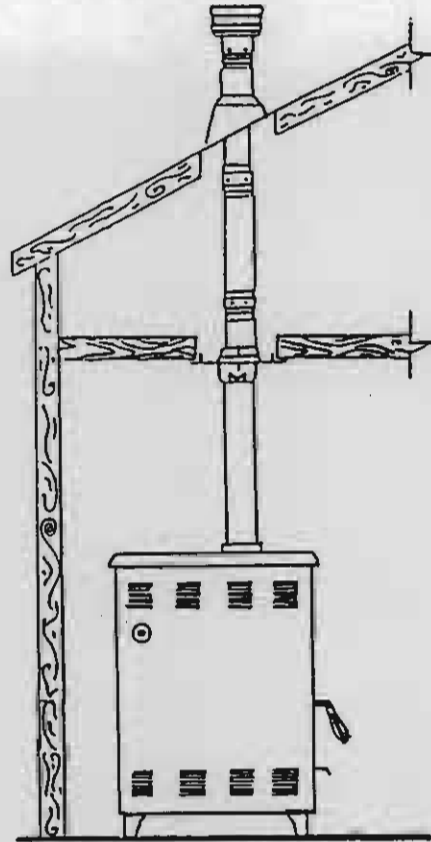

The most desirable installation is Pellet Vent pipe connected to the top of the stove and run up through the ceiling (no offsets), then terminating above the roof line. Be sure to follow all clearances listed by the pipe manufacturer.

Connection To A Masonry Chimney

If you are going to utilize an existing chimney system (Masonry or Class A), the 4" pipe must be run all the way to the top. You may use single wall flex or rigid (26 gauge galvanized or stainless steel) pipe as an approved liner.

INSTALLATION

Outside Air Provision

Although this section applies to manufactured home installations, it may also be required by local codes in standard residential installations. Use the manufacturers Optional Outside Air Kit (part # 18465).

1. Set the stove in its installed position and mark the floor location for outside air penetration. The air ducting must connect with the bottom of the cabinet of the stove, using metal ducting to match the Outside Air Kit opening.
2. Cut an opening for the Outside Air Kit (Part # 18465).
3. Install the Outside Air Kit, per instructions included.

Mobile Home Installation Requirements

Installation of the RP45 into manufactured housing must follow the instructions for residential installation, with the following supplemental requirements per OAR 814-23-900 through 814-23-909:

1. No single wall pipe may be used as a connector or chimney. Pellet Vent pipe must be used from stove top to termination.
2. Maximum two 45° offsets ending in vertical termination, permitted.
3. The chimney must provide for a section joint so that any parts extending above 13' 6" from ground level can be removed for transportation of the mobile structure.
4. The stove must be grounded to the mobile home trailer frame with a No. 8 (minimum) solid conductor.
5. The combustion air must communicate to the outside air.
6. Floor protection must cover the area beneath the stove and extend one inch beyond the base on all sides.
7. Structural members such as roof trusses or floor joists cannot be cut or modified while making the installation.

MAINTENANCE

Ash Removal and Disposal

CAUTION: BE SURE THE FIRE IS OUT AND STOVE IS COLD BEFORE REMOVING ASHES! NEVER BURN YOUR STOVE WITH THE ASH DRAWER OPEN.

Ashes can hold live embers for several days, and must be disposed of with care. Be certain the fire is out before you remove the Ash Drawer. Rotate the ash drawer latches and pull out the drawer. After emptying, clean and replace the Ash Drawer and close the latches. NEVER place ashes in a cardboard box or any other combustible receptacle. Place the ashes in a metal container with a tight fitting metal lid. The closed container should be stored on a noncombustible surface away from combustible materials. Keep the ashes in the closed container until you are certain all the cinders have completely cooled.

Door Gasket

A spun fiberglass gasket (3/4" in diameter) provides the seal around the fuel door. Should this become frayed or damaged it should be replaced. Spun fiberglass "rope" gasketing can be purchased from your local dealer. It must be the same diameter as the original. Use high temperature (RTV) silicone sealer as an adhesive.

WARNING: MAINTAIN THE DOOR SEAL IN GOOD CONDITION. DO NOT ALLOW THE STOVE TO BURN WITH THE DOOR OPEN OR AJAR OTHER THAN DURING THE START-UP PROCEDURE.

Creosote Formation and Need for Removal

If your stove is properly adjusted, very little creosote will develop in your flue system. If creosote begins to develop, it is likely that poor adjustment or needed maintenance is causing incomplete combustion of the fuel. Be sure your Damper Slide is set properly.

Creosote is caused by a high moisture content of the fuel in relation to the rate at which it is burned. Burning a stove on low feed rate for long periods of time causes incomplete combustion which creates vapors that may condense in a relatively cool chimney, forming creosote. Creosote deposits tend to form in long runs of venting where gases become too cool prior to exhausting.

Soft fly ash is a normal by product of burning pellet fuel, and can accumulate in your flue system. Using lower grade fuel will increase the frequency of cleaning that will be needed. Check your flue regularly (at least once a month) until a schedule can be established for your installation and fuel quality. Remember, during high use periods to increase your inspection cycle.

Note: Single wall pipe cools rapidly, therefore installations using this type of flue are more susceptible to creosote deposits.

Paint

Your stove is finished with a high temp paint that requires time and temperature to completely cure. Depending on your use, this may take a few hours or a few days. Do not attempt to repaint the stove until the paint is completely cured. Do not place anything on the stove surface until the stove has gone through several heat up/cool down cycles, as the paint will soften some before it cures.

MAINTENANCE

Firepot

Keep the Firepot inner holes free of obstructions (buildup). Pull the Firepot and empty if this occurs. The quality and quantity of pellets used will dictate the necessary cleaning. Remove any clinkers or carbon build up before restarting the stove.

Clinkers are a by-product of the fuel. Silica (or dirt) in the fuel, along with other impurities can fuse under heat and cause clinkering. Clinkering is a function of the fuel, not the stove.

Cleaning the RP45

1. Turn the unit off two to three hours before cleaning to allow for cooling (see Shut Down Procedure).
2. Place protective floor covering around the front of the stove.
3. Remove the Firepot by lifting it up from the housing and pulling out. Clean and empty into a non-combustible container.
4. Remove Ash Drawer and empty ashes into your noncombustible container. Dispose of ashes as previously described (see Ash Removal and Disposal). Clean any remaining ash from the Firebox and Ash Drawer area.
5. Twice a burning season remove the chimney connector pipe and determine if chimney needs to be swept.

6. After the stove chimney has been inspected, and/or swept, the heat exchanger clean out cover needs to be removed to vacuum out the stove. Remove the front panel by opening the door, this will expose the four front panel mounting screws. Remove these screws and lift off the front panel. Remove the six screws holding the clean out cover to the front of the stove.
7. Vacuum all three levels of the Clean Out Access.
8. Replace clean out cover and front panel. Reinstall your Firepot being sure that it sits all the way into its opening. Replace the door, ash drawer and reseal and secure the chimney if removed.

The necessary frequency of this procedure will be dictated by the quality and quantity of the fuel burned. The following is the suggested schedule to establish a minimum: After every 1/2 ton of pellets, when the metal surfaces of the exchange tubes are no longer visible, or after every 2-3 weeks of use.

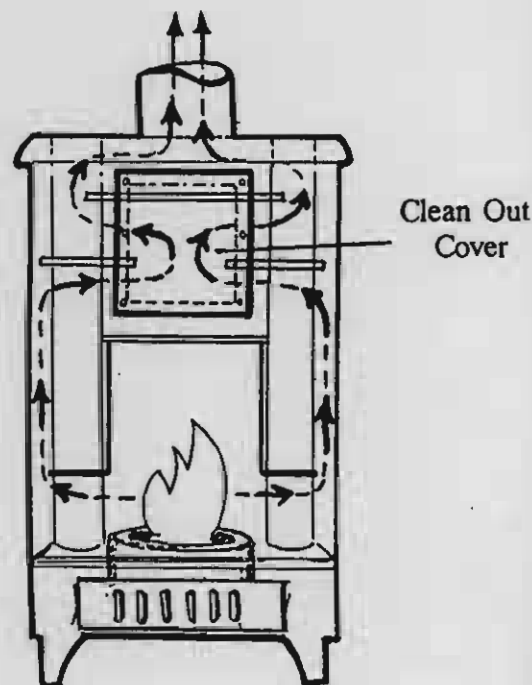

POWER FLOW DIAGRAM

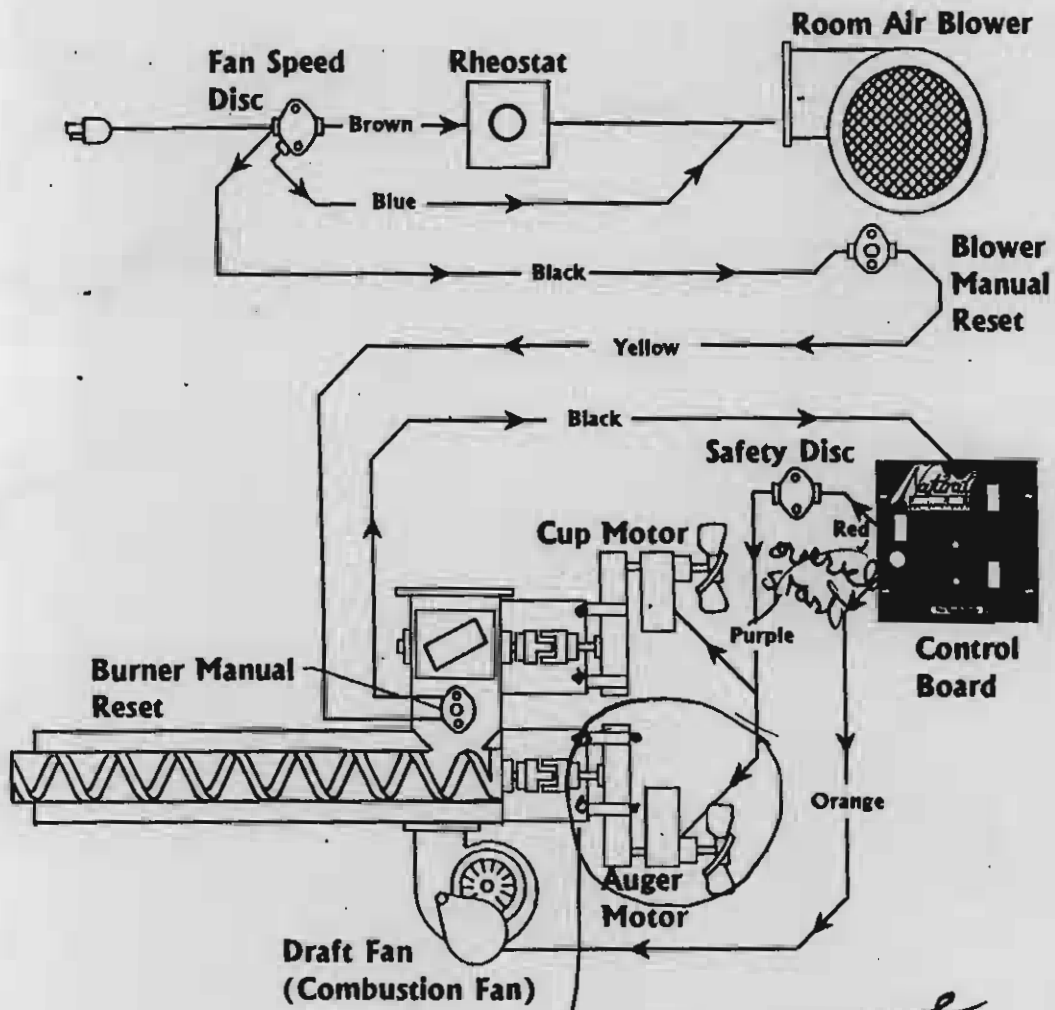

*box end
Ratchet to remove*

HOW IT WORKS

There are essentially two systems on all Natural Fire Appliances.

- One which operates the room air fan,
- And one which controls the burner or fuel input/heat output rate.

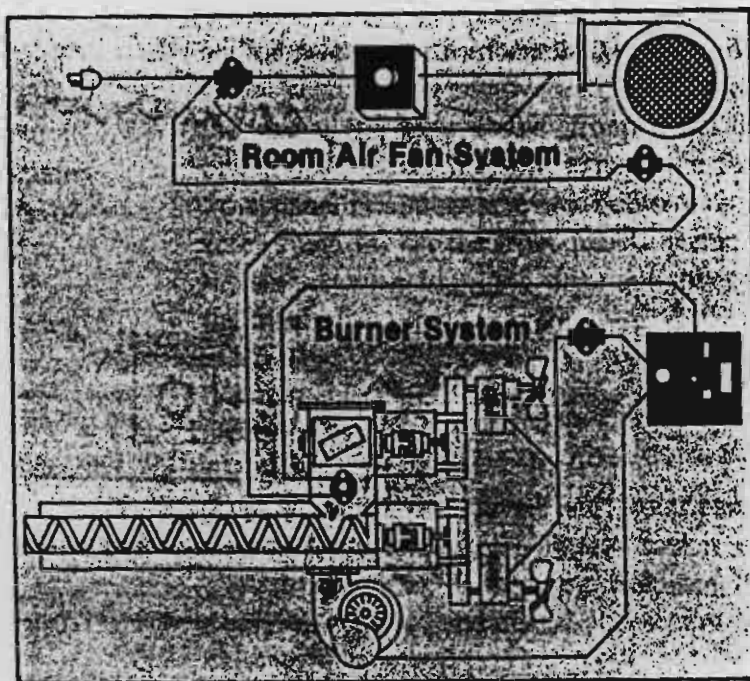

ROOM AIR FAN SYSTEM

First, let's concentrate on the room air fan system, which consists of the rheostat, the fan speed disc and the room air fan, or fans. See figure 1.

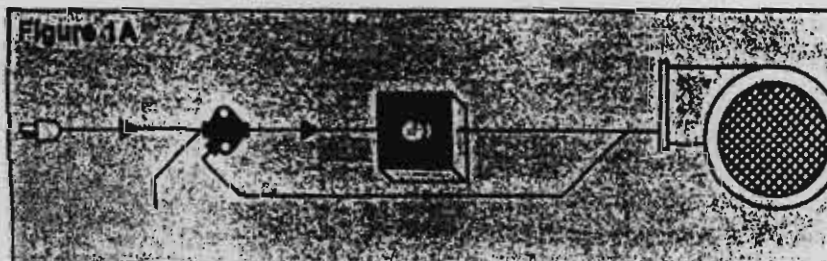

Figure 1

RHEOSTAT

The rheostat receives power directly from the power cord. With the rheostat control knob in the "off" position, no electricity flows to the fan. This can, however, be over-ridden by the "heat rise" feature, which we will cover in a moment.

When the rheostat control knob is turned clockwise it "clicks", indicating the fan is receiving full line voltage of approximately 110 volts, and operating at full speed.



Voltage and fan speed can be reduced by turning the control knob further in a clockwise direction. At the lowest setting, the fan is operating at half of full speed, or about 65 volts.

FAN SPEED DISC

During low to moderate heat conditions the fan speed disc allows power to flow through the rheostat to the room air fan. See figure 1B.

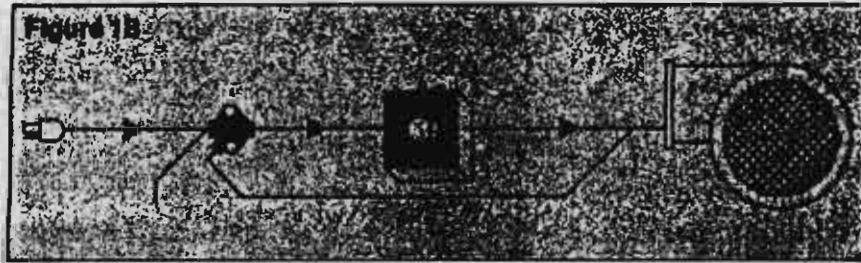

As the heat on the fan speed disc rises above 140 degrees, full power is diverted directly to the room air fans. See figure 1C. When heat is evacuated, or the temperature drops below 120 degrees, the rheostat regains control of the fan.

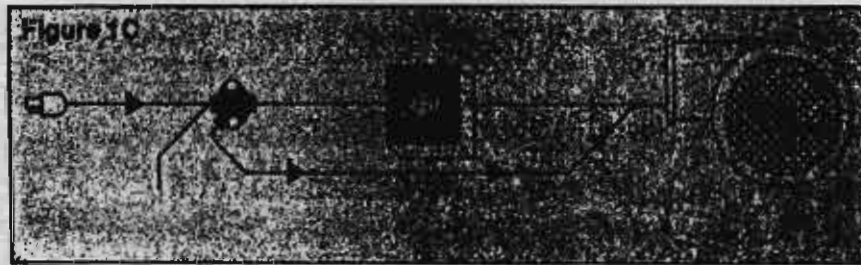

ROOM AIR FAN

The room air fans circulate cooler room air through the heat exchanger, extracting heat from the appliance and warming the room.

BURNER SYSTEM

Now let's move to the burner system. This system consists of a control board, safety disc, blower manual reset, burner manual reset, draft fan motor, cup motor and auger motor. An optional thermostat may be included. See figure 2.

Before electrical current can activate the control board it must pass through two very important features. The blower manual reset and the burner manual reset. Power is supplied to these components through the fan speed disc. Consult the operator's manual for the exact location of each on specific models.

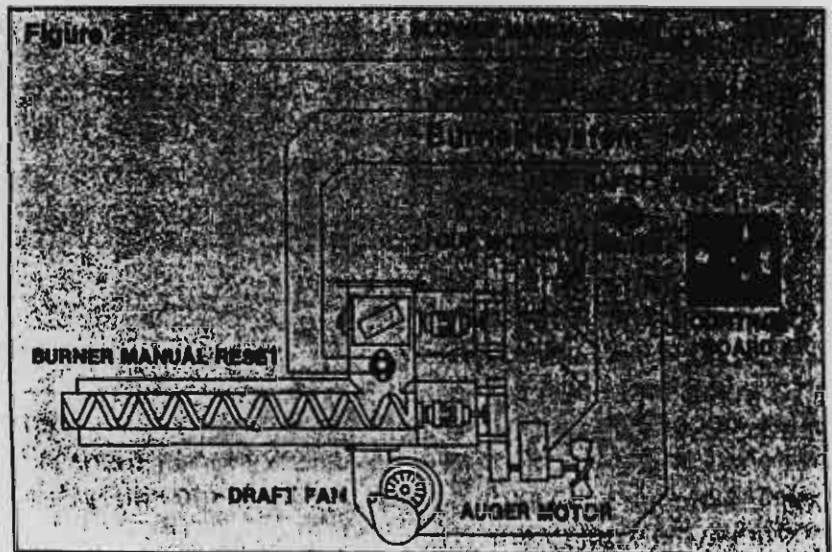

BLOWER MANUAL RESET

The purpose of the blower manual reset is to prevent an overfiring of the appliance. Should temperatures in the upper air chamber exceed 200 degrees the disc will shut off power to the control board. The cup, auger and draft fan motors will cease operation, and the fire will go out. The room air fan will continue to cool the appliance. See figure 3.

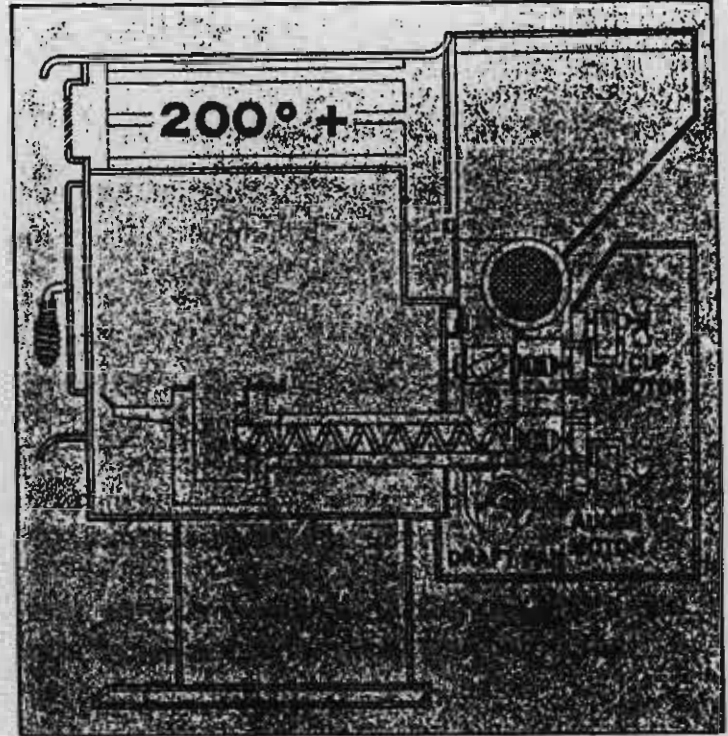

Figure 3

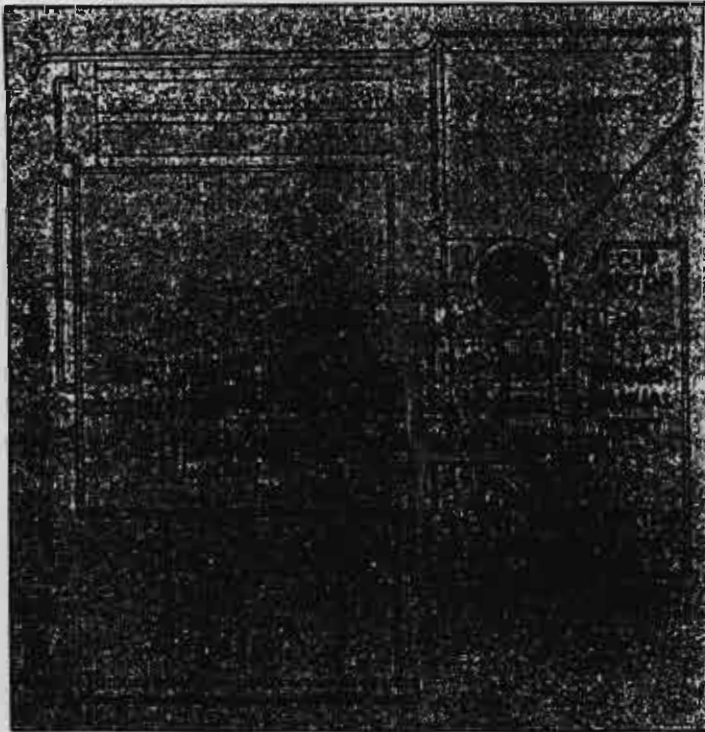

Figure 4

BURNER MANUAL RESET

In the unlikely event excessive heat should ever build up in the auger tube, the burner manual reset will shut off power to the control board. This action causes the cup, auger and draft fan motors to cease operation, and the fire will go out. This prevents heat from reaching the fuel storage hopper. See figure 4.

SAFETY DISC

Even though there is power to the control board, the burner will not run until the safety disc is switched on by sufficient heat. If for any reason there is insufficient heat during operation, the safety disc will disengage, causing the burner to shut-off. The stove must remain hot for the safety disc to maintain operation.

CUP MOTOR

The cup motor rotates the fuel metering cup, picking up the fuel. The fuel falls through a drop zone which, along with the metering cup, isolates the fuel storage hopper from the direct feed system. See Figure 7.

These two components, when combined, form this very important safety feature of the Natural Fire System.

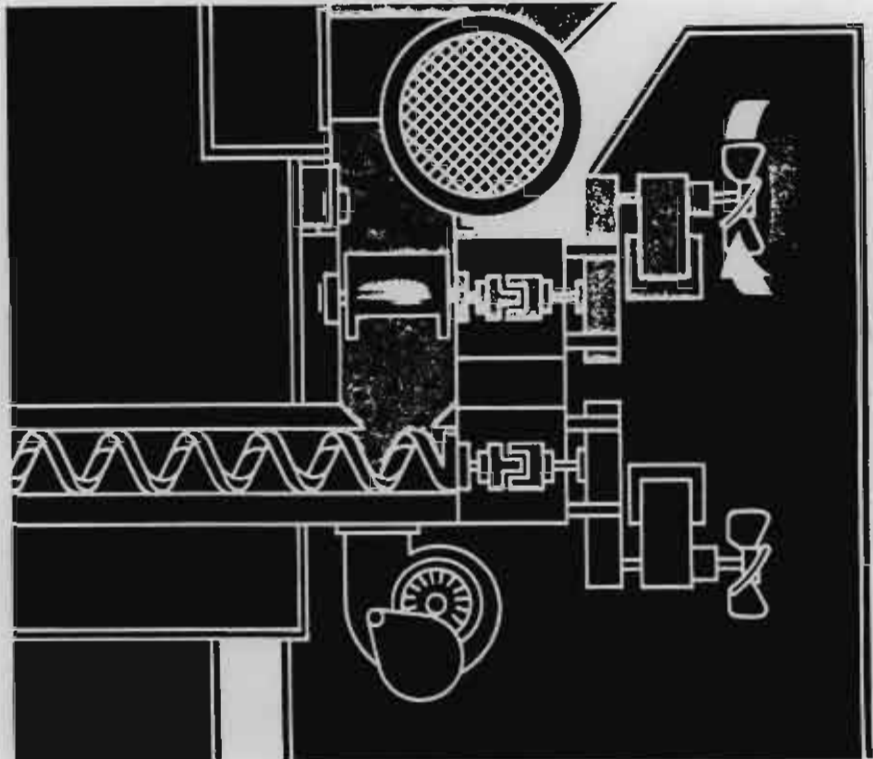

Figure 7

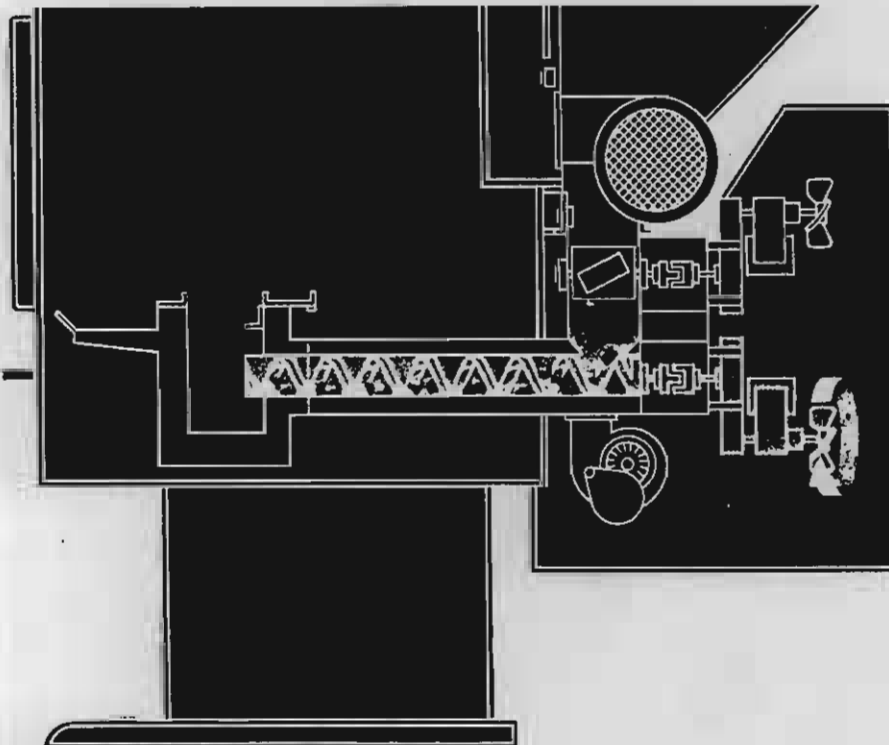

Figure 8

AUGER MOTOR

The motor turns the auger, delivering fuel to the fire pot. See figure 8.

DRAFT FAN

At the same time, the draft fan is forcing combustion air down the burner and auger tube to the fire pot where combustion occurs. See figure 9.

The flame can be adjusted by regulating the air shutter on the draft fan. Approximately 50% open is correct for most fuels.

During combustion, flame and hot gases are directed through the heat exchange system. The room air fan extracts the heat and delivers it into the room. See figures 10 and 11.

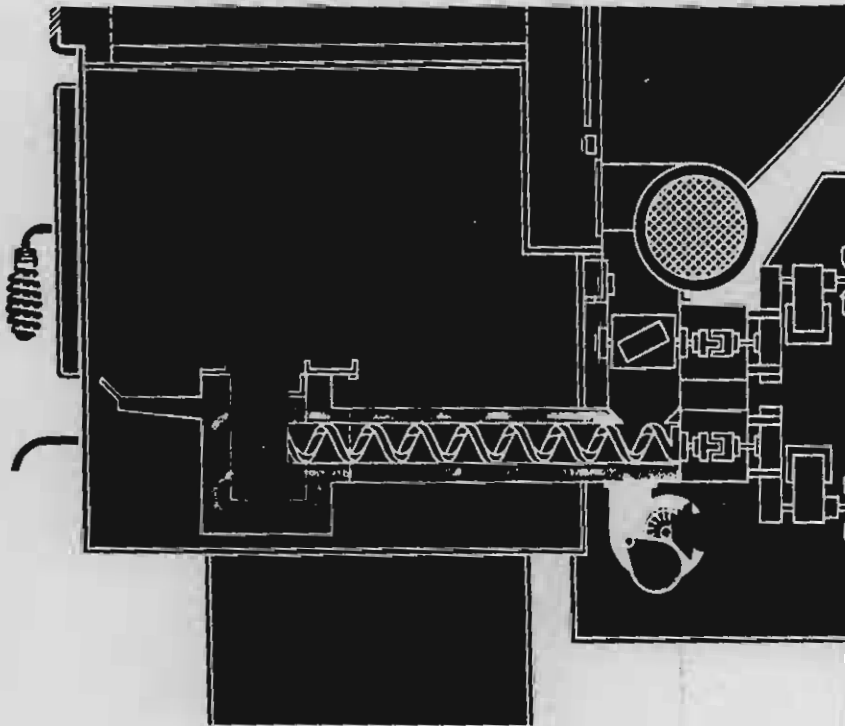
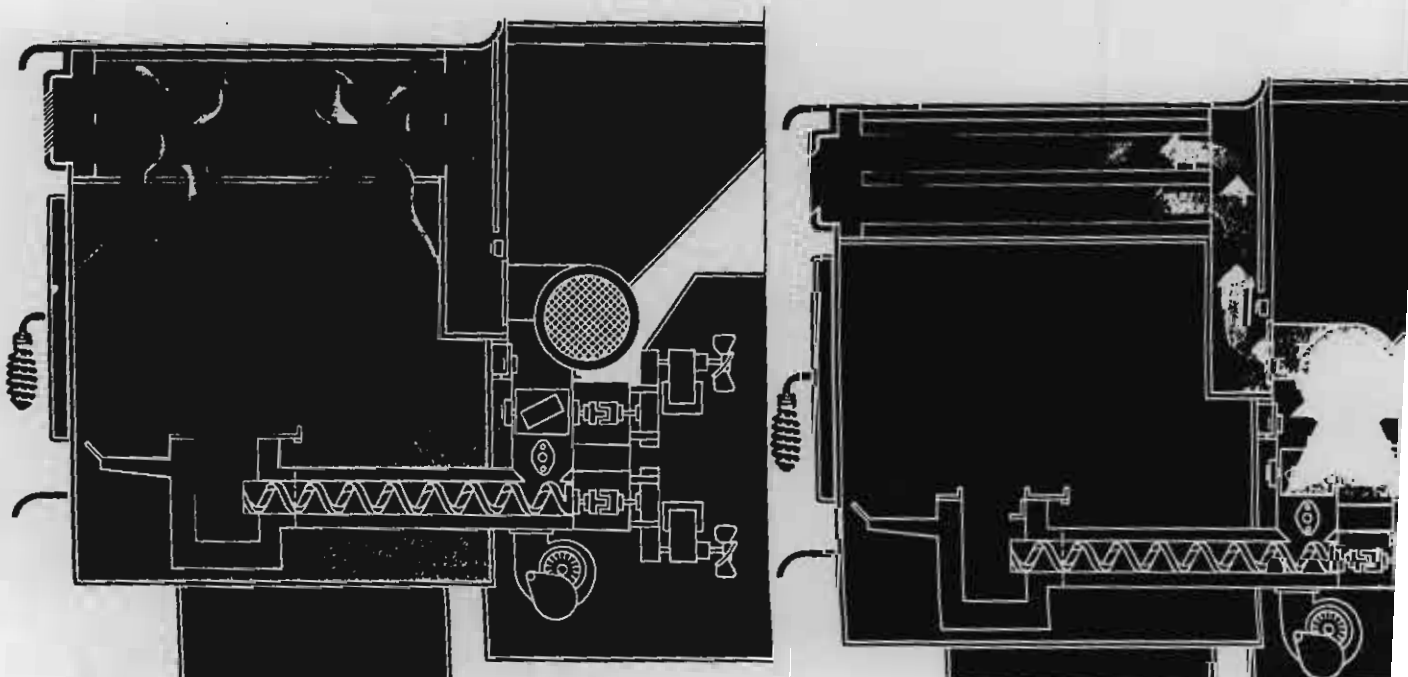

Figure 10



OPERATION

Control Board

A. MAIN POWER SWITCH

The Main Power Switch is a three way toggle with the following positions:

1. Off (Stove Off)
2. Draft Fan - allows the Draft Fan to operate alone during shut down.
3. Feed System - Stove On

B. FUEL RATE SWITCH

The Fuel Rate Switch controls the amount of time the burner feeds fuel. It can be set to the following three positions:

1. Full - will feed fuel continuously.
2. Medium - will feed fuel approximately two minutes on then two minutes off.
3. Low - will feed approximately one minute on then three minutes off.

C. DRAFT FAN SWITCH *

The Draft Fan Switch controls the amount of air used for combustion during piloting process. It can be set to the following three positions:

1. High - runs at 75% of capacity when stove is not feeding fuel.
2. Low - runs at 50% of capacity when stove is not feeding fuel.
3. Off - runs at 0% of capacity when stove is not feeding fuel.

* The Draft Fan will run at 100% of capacity during the feeding of fuel.

D. START BUTTON

Depress the Start Button to allow fuel to feed for approximately 12 minutes (used during start up of the stove).

E. ON/OFF LIGHT

The On/Off Light blinks to indicate electricity is flowing through the Primary Control Board.

F. FUSE

The Fuse protects the Primary Control Board from power "surges or spikes".

Optional Remote Thermostat

One way to maximize the efficiency and convenience of your stove is to install a remote Thermostat. A Honeywell T87F 24 volt Thermostat is recommended.

Follow the manufacturer's installation instructions using 18/2 stat wire. The leads from the stove are the yellow wires found behind the Primary Control Board.

Once you have installed the Thermostat, the Fuel Rate Switch should be set to "Low". This will be the rate the stove will run on pilot when the Thermostat is not calling for heat.



INSTALLATION

Recommended Pre-Installation Procedure

NOTE TO INSTALLER: Before the unit is installed it is recommended that the unit be pre-burned to verify the operation, to burn off oils that are sometimes found in the Heat Exchange Tubes, and to cure the paint. The "Pre-Installation Procedure" should be done in a well ventilated area as follows.

1. Remove the Baffle Plate from the pallet and place it on the brackets inside the stove. The brackets are located below the Heat Exchange Tubes at the rear and above the door at the front. Make certain the Baffle plate is placed all the way to the rear and left hand side of the unit and not centered. The heat exchanger cleaner plate handles should fit into the two notches in the baffle plate
2. Plug the stove into a grounded outlet (using a circuit tester, verify the electrical outlet for proper ground and polarity where the unit will be installed. Failure to do so could result in damage to the electrical components and void the warranty).
3. Check the shutter on the Draft Fan and make sure it is set at 1/2 open (once installed the actual setting will depend upon the draft of the flue). On the Primary Control Board, A) set the Main Power Switch from "Off" to the "Draft Fan" position and B) put the Fuel Feed Rate on "Full". The Draft Fan should now start. Open the door, place your hand over the Firepot and see if the Draft Fan is forcing air into the Firepot. Turn the Main Power Switch to the "Off" position.
4. Turn the Rheostat "On" to see if the Room Air Fan runs. After checking the fan, turn the Rheostat "Off".
5. Look down into the Hopper, and make sure nothing is obstructing the Fuel Metering Cup. Pour 1/4 bag of pellets in the Hopper.
6. With the Main Power Switch in the "Feed System" position, push the Start Button. Allow fuel to feed for approximately five minutes or add two cups of pellets by hand to the center of the firepot. Put the Main Power Switch in the "Off" position. Apply non-volatile lighting material to the pellets and light it with a match. Let the fuel burn for five minutes leaving the door slightly ajar.
7. Close the door and set the Main Power Switch to the "Feed System" position, and the Fuel Rate Switch to the "Full" position. Push the Start Button. The Draft Fan will run at high and the flame will increase (a full flame will need to be established in the Firepot before normal operation can be maintained).
8. Once running, observe the stove operating for 15-30 minutes.
9. As the stove temperature rises, the Room Air Fan will automatically be engaged. Set the Rheostat to the desired speed.
10. If necessary, adjust the Draft Fan Shutter to bring the fire to a bright yellow flame.
11. Once the stove is operating properly, complete filling the Hopper and run the unit for 30 minutes.

MAINTENANCE

Maintenance Suggestions

As with all appliances, periodic maintenance is required to keep them operating at optimum efficiency. We recommend an annual maintenance service by a qualified technician.

Recommended Maintenance Points

- A. Once for every 1/2 ton of fuel burned, remove all dust and fly ash from Heat Exchange Tubes and Baffle areas using the cleaner plate.
- B. Remove and clean the Firepot. Keep inner air holes free from buildup. Remove ashes from the Firebox weekly or as fuel dictates.
- C. Clean chimney, cap and exhaust passage way annually or as needed. Inspect monthly.
- D. Vacuum air intakes and squirrel cage on Room Air Fan annually.
- E. Clean squirrel cage on Draft Fan annually.
- F. If remote Thermostat is used, remove cover and clean contacts annually.
- G. Replace Door Gasket as needed.
- H. Replace Ash Drawer Door Gasket as needed.

Maintenance Related Problems

Problem: Decrease in heat output or incomplete combustion.

Solution: See maintenance points A, B, C, D and E (above).

Problem: Decrease in Room Air Fan velocity.

Solution: See maintenance point D (above).

Problem: Stove smokes or odor in home.

Solution: See maintenance points A, B, C, G and H (above).

Problem: Flames appear to burn lazily.

Solution: See maintenance points A, B, C, and E (above).

Problem: Noticeable change in Room Air Fan noise.

Solution: See maintenance point D (above).

If solutions fail to cure problem, See Trouble Shooting Section.

BURNING CORN: Naturalfire™ (Optional)

Natural Fire pellet stoves will burn most types of corn with the addition of a Corn Pot kit. It is not necessary to mix corn with wood pellets however, wood pellets are required to start the fire.

NOTE: *Burning treated seed corn is never recommended.*

The Corn Pot kit consists of:

- 1 1/8" Filler Plug
- 1 3/8" Filler Plug
- 1 Corn Pot

To install the Corn Pot, simply remove the screw(s) from the top of the Auger Housing and lift up and out on the Firepot. Slide mounting flange of the Corn Pot over the Auger Housing and replace screw(s).

Initially the Air Shutter on the Draft Fan should be set at 1/2 open and the Draft Fan selector on "LOW". If more or less combustion air is needed, adjust the Air Shutter accordingly to achieve a bright yellow flame.

Because corn size and density varies, it will be necessary to calibrate the Fuel Metering Cup in order to maintain rated BTU input and prevent overfiring. This requires the installation of the Filler Plug in the Fuel Metering Cup. Use the 3/8" filler plug provided in the Cornpot kit.

The moisture content of the corn should be 15% or less, and care should be taken to ensure that there are no foreign objects in the corn (i.e. stocks, stalks, cob parts, etc.). When burning corn, the primary combustion takes place on a bed at the bottom of the Corn Pot.

The Corn Pot has a solid bottom and sides with air holes because burning corn forms a fluid-like residue which becomes solid when cool. The Corn Pot cleaning will depend upon the quality and quantity of corn being used. The Cornpot should be cleaned when the build up starts to reach the bottom air holes inside of the Cornpot. You will need to remove the ash, and in some instances a white calcium like deposit. The stove must be shut down and cooled before cleaning.

CORN BURNING SHOULD BE DONE IN TOP VENT INSTALLATIONS ONLY. If the installation must elbow into a wall thimble, the horizontal run should not be more than 24". The use of a wall mounted Thermostat, part #CTR140 is suggested.

Start Up Procedure

We recommend starting a corn fire with wood pellets because corn has a dense shell that can be difficult to start. Manually fill the Cornpot, to the bottom of the Auger Tube, with wood pellets. Use of the Start Button feature is not recommended when initially starting the unit for corn burning.

Filler Plug Installation

Place the filler plug into the bottom of the metering cup fuel cavity and secure with the screw provided into the tapped hole.

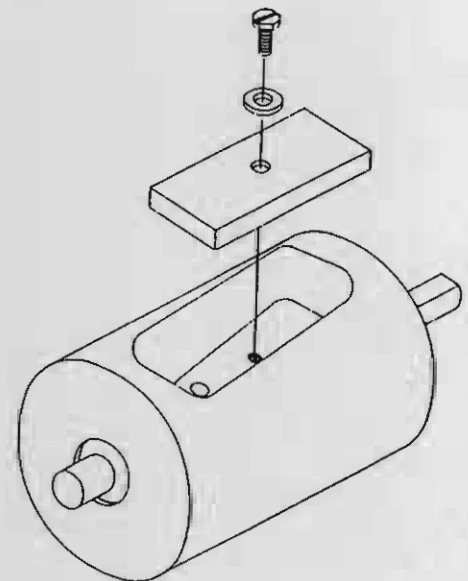

BURNING CORN: RP45 (OPTIONAL)

Burning Corn (Optional)

The RP45 pellet stove will burn most types of corn. It is not necessary to mix corn with wood pellets however, wood pellets are required to start the fire. NOTE: Burning treated seed corn is never recommended.

The moisture content of the corn should not exceed 15%, and care should be taken to ensure that there are no foreign objects in the corn (i.e. sticks, stalks, cob parts, etc.).

To burn corn, a 15050-5 1/8" thick corn plug must be installed in the fuel metering cup. The lowest setting that will sustain combustion of corn is medium - low. At this setting the damper slide needs to be in the closed position.

When burning corn, the primary combustion takes place on a bed at the bottom of the Firepot. The frequency of Firepot cleaning will depend upon the quality and quantity of corn being used. The Firepot should be cleaned when the build up reaches the air holes on the side of the Firepot. You will need to remove the ash, and in some instances a white calcium like deposit. The stove must be shut down and cooled before cleaning.

When burning corn, the primary combustion takes place on a bed at the bottom of the Firepot. The frequency of Firepot cleaning will depend upon the quality and quantity of corn being used. The Firepot should be cleaned when the build up reaches the air holes on the side of the Firepot. You will need to remove the ash, and in some instances a white calcium like deposit. The stove must be shut down and cooled before cleaning.

Start Up Procedure (Corn)

We recommend starting a corn fire with wood pellets as corn has a dense shell that can be difficult to start. Manually fill the Firepot with about two cups of wood pellets.

Filler Plug Installation

Place the filler plug into the bottom of the metering cup fuel cavity and secure with the screw provided into the tapped hole.

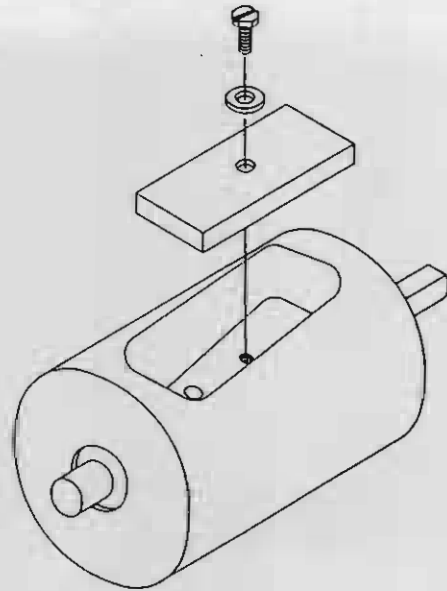

SUGGESTED TOOLS-SUPPLIES & PARTS

TOOLS

Volt Meter	Wire Stripper & Cutter
Circuit Tester (Micronta # 22-101)	Vise Grips
*Ratchet Wrenches, 1/4"-5/16" & 3/8"-7/16"	Three-Way Adaptor
Allen Wrenches, 1/8" & 3/32"	Tape Measure
Molex Pin Extractor (1/8")	Soldering Gun
Set of Screwdrivers (Flat & Phillips)	Hammer
Socket Set, 3/8" & 1/4" Drive	Shop Vac
Extension Cord (50')	Flashlight
Draft Meter	Hack Saw
Crescent Wrenches (8" & 12")	Fire Extinguisher
Pliers (needle nose)	Drill & Bits

* Some wrenches may not fit. Proto (brand) is recommended.

MISC. SUPPLIES

Drop Cloth	Foil Tape
Hand Soap	Shop Towels
Chimney Brush	Heat Exchanger Brush
Electrical Tape	Duct Tape
Pellets (40lb. bag)	Firestarter
Anti-Seize Silicone Spray	Liquid Graphite
WD-40 Spray	Furnace Cement
Stove Paint	Oil Can w/ Spout
Screws (sheetmetal)	Thermostat Wire (18/2)
Fuses (Balkamp #782-1046 AG3)	Misc. Wire Nuts

MISC. PARTS

Auger Motor (6rpm)	Rheostat
Cup Motor (1rpm)	Safety Disc (120°-110°)
Room Air blowers (left & right)	Manual Reset (200°)
Draft Fan (60cfm)	Fan Speed Disc (140°-120°)
Door Gasket (1/2" & 3/4")	Couplers (3/8" & 1/2")

Never throw parts at stoves. Virtually all problems are fuel, installation, operation, or maintenance related. Before assuming a part is bad - take a minute that may save hours and rule out the following:

1. Fuel problem
2. Maintenance problem
3. Adjustment problem
4. Installation problem

If you are certain these are not the cause of the problem: Check for a defective part.

Trouble Shooting

When problems occur, it is imperative to solve them quickly and correctly. This requires a systematic approach to the trouble shooting process.

Virtually all problems fall into one or more of the following categories:

- Installation/Adjustment
- Operator error
- Fuel
- Maintenance

A problem in one of these four categories will prevent the appliance from performing properly, despite the fact that all parts and operating systems are in good working order. This highlights the fact that solutions do not result from throwing parts at the problem.

Applying these four principles will greatly simplify the procedure:

1. Analyze the symptom
2. Eliminate the improbable
3. Identify the possible
4. Isolate the problem

These principles can be used to trouble shoot and solve any problem you may encounter.

Installation/Adjustment Related Problems

Problem: Incomplete combustion, unburned fuel.

Solution: Adjust air shutter to a more open position.

Problem: Burns fuel too quickly and may have difficulty holding a fire on low.

Solution: Adjust air shutter to a more closed position.

Problem: Room air fan(s) hum or won't start on low rheostat setting.

Solution: Adjust low end voltage on rheostat for 65 volts output.

Problem: Auger squeaks.

Solution: Adjust pillow block bearing for auger.

Problem: Unit goes out when operating on low and room air fan(s) on.

Solution: Move room air fan rheostat to lowest setting or off. Draft fan/combustion switch may require lower setting.

Problem: Unit uses too much fuel.

Solution: Time and calibrate fuel metering cup for specific type and density fuel being used.

Problem: Lack of heat and/or excessive flue temperatures.

Solution: Baffle not installed or installed incorrectly.

Problem: Abnormally long time for safety disc to lock in or drops out prematurely.

Solution: Adjust disc to touch stove surface.

SIX STEP TROUBLE SHOOTING GUIDE

Tools Essential For Trouble Shooting

1. Stove Installation and Operation Manual
2. Circuit Tester (Micronta #22-101)
3. Molex Pin Extractor, 1/8" (E.S. #15068)
4. Volt Meter

ATTENTION: Before attempting any trouble shooting; 1) Check your outlet to see that you do have power and the outlet is wired properly (Use Circuit Tester); 2) Check the flue for blockage of any type; 3) Take the time to clean the stove; 4) Note the model number of the Primary Control Board.

Step #1

Room Air Fan System Check

Turn the Rheostat Knob till it "clicks", it is now "ON". In the "ON" position the Room Air Fan will operate at full speed (115v). Place your hand in front of the air outlet to confirm that air is coming out. Further rotation of the knob will slow the Room Air Fan. The lowest setting is approximately 65 volts. If the Room Air Fan comes on and operates properly as described, the source of the problem will not be the Rheostat, Room Air Fan, Fan Speed Disc, wiring connections or circuitry.

Should the Room Air Fan fail to come on, the first step in finding the problem is to check the power source. The power source can be easily checked with a Circuit Tester or simply plugging a lamp or other small appliance into the outlet. Once it's determined there is power to the outlet, the Room Air Fan motor can be checked by removing the leads from the Molex connector and connecting them to a 115v power source. If the Room Air Fan runs, the problem is a loose connection. If the Room Air Fan fails to run, replacement will be necessary.

Step #2

Confirm Power to Control Board

Turn Main Power Switch from the "Off" position to the "Draft Fan" position. If the Red Indicator Light comes on, there is power to the Primary Control Board. If the light does not come on, check the following:

- A. Power source (see Step 1)
- B. Fuse
- C. Blower Manual Reset
- D. Burner Manual Reset

If the fuse is not blown and both Reset Buttons have not "popped out", inspect the Molex connectors and be certain the pins are making contact. Finally, using a Volt Meter check for power at the power switch. If the Volt Meter indicates 115v and the Red Indicator Light still is not on, it will be necessary to replace the Primary Control Board.

SIX STEP TROUBLE SHOOTING GUIDE (Cont.)

Step #3

Confirm Draft Fan Operation

Be sure the Main Power Switch is in the "Draft Fan" position and move the Fuel Rate Switch to the "Full" position. This will cause the Draft Fan to operate at full power (115v). (During the piloting process, the Draft Fan will operate at 70-75 volts when the Draft Fan Switch is on "High", it will receive 60-65 volts with switch on "Low" and zero volts when on "Off"). You should be able to hear the Draft Fan come to full speed. If you can't hear the Draft Fan and the stove is cold, you can check for movement of air by placing your hand in or near the Firepot. If the movement of air is not obvious, inspect the Draft Fan to be certain the Air Shutter is open. If the Air Shutter is open and the Draft Fan is not running, check it by using the procedure in Step 1, paragraph 2.

Step #4

Inspect Fuel Metering Cup for Blockage

To inspect the Fuel Metering Cup, first empty the Fuel Hopper. Reach down through the Hopper and rock the Fuel Metering Cup back and forth. The Cup should move approximately 1/4" in either direction. If it does not move, something is jamming it (usually a foreign object) and will have to be removed. Sometimes the obstruction can be removed by simply rotating the Cup slightly. This can be done by turning the propeller on the cup motor clockwise (by hand). It may take several minutes of turning to rotate the metering cup enough to clear the obstruction. If this procedure does not correct the problem, you will have to remove the Cup Motor and pull the Cup to find the obstruction.

Step #5

Confirm Cup and Auger Motor Operation

Set the Main Power Switch to the "Feed System" position. Press the Start Button. Both the Cup and Auger Motor should start now. If the motors run but the Fuel Metering Cup and/or Auger do not turn, check the cast iron Coupler on the ends of each motor shaft to make certain the set screw is tight on the flat part of the shaft. If the motors are not running, use a Volt Meter to check for line voltage (115v) at the Molex connector or check them by using the procedure described in Step 1 paragraph 2. Note: Anytime you are checking the motors, you should verify the speed at which the motors are turning. This can be accomplished by timing the revolution of the Coupler. Using the set screw as a reference point, the bottom motor (Auger) will make one revolution in 10 seconds. The top motor (Cup) will make approximately 1 revolution every 45 seconds.

Step #6

Re-light The Stove

Follow the normal start up procedure. If the unit fails to start, check to be certain the leads to the Safety Disc are attached.

CONTROL PANEL TROUBLE SHOOTING FEED SYSTEM RUNS ON HIGH ONLY

The procedure for correcting a control panel that allows the feed system to run all the time regardless of the feed setting.

1. Check for the proper polarity and grounding of the outlet where the stove is plugged in (do not use an extension cord).
2. If the stove is operating on a remote thermostat, make sure the base plate is level and the thermostat wires are not touching each other.
3. If the stove is not operating on a remote thermostat, make sure that the two yellow pre-wired leads from the control panel are not touching each other or any stove part.
4. Shut down the feed system and let the draft fan run to burn up the remaining pellets.
 - A. If this is a model 500S control panel:
Move the feed rate switch to the low position. If the feed does not go to low feed, unplug either the red or purple wire to the safety disc to stop the feed system.
 - B. If this is a model 1000 or Emerson control panel:
Move the 3-way toggle switch (off/draft fan/feed system) switch to the draft fan position.
5. After the stove has cooled down and all of the remaining fuel has been consumed, unplug the stove (for at least 5 minutes).
6. Check all four of the screws for mounting the control panel to make sure they are tight and have good contact with the stove side panel (paint sometimes allows an insulating barrier which prevents a good ground). This can cause a malfunction in the counting procedure of the control panel.
7. If you had previously unplugged the red or purple wire to the safety disc, reattach it now.
8. Plug the stove back in to the outlet.
9. Restart the stove.
10. Allow the feed system to run on high until a lively fire has been established and the stove safety disc locks in.
11. Adjust the settings for the feed rate and draft fan to their low settings. The feed system should feed for about 1 minute, then pilot for 3 minutes. The draft fan will run full speed during the feed cycle and low speed during the pilot cycle.
12. If the stove feed rate is still running on high feed only, it will be necessary to replace the control panel.

CONTROL PANEL TROUBLE SHOOTING

FUSES BLOWING

The procedure for repairing a stove which has a control board that continually blows fuses.

1. Check for the proper polarity and grounding of the outlet where the stove is plugged in (do not use an extension cord). Do not replace the control board prior to the following steps (the new control board could be damaged).
2. A surge protector is recommended.
3. Check the 9- way molex from the control board to make sure that the wire colors match up with the correct wires (this will be a 6-way molex on the 500 board). The gray & light blue wires should not match up with anything (they are used for testing at the factory).
4. Check the entire wiring harness to make sure there are no wires that are shorting out, such as bare wires making contact with the stove body (crimped in hopper flange, etc.). This can be done by checking continuity with a volt meter (see note A below).
5. Make sure the fuse cap is making proper contact and is in the locked position. This could cause arcing which may result in fuse failure.
6. Unplug the 6 pin molex connection where the cup motor, auger motor and draft fan wires are hooked to the wiring harness (this is located near the motor). Turn on the control board, then set all the switches to their highest settings for 1 minute, then adjust to their other settings. After 3 minutes, check to see if the control board light is still on. If it is ON, proceed to step 7. If it is NOT ON, you have a bad control board. DO NOT replace the defective control board until the following checks have been done.
8. Check the cup motor, auger motor and the draft fan individually by hooking each up to direct line voltage (110 volts approximately). This can be done by unhooking the two black leads on the motor (use a molex pin pusher to remove the lead from the 6-way molex). Plug the two leads from the motor into an extension cord, then plug the extension cord into an electrical outlet. Let each motor run for 5 minutes. If the motor starts to smoke, you have found the problem (motor shorting out).
9. Check what else is on the circuit in the house. If there are too many appliances plugged into that circuit, it may cause voltage fluctuations. Check the outlet with a volt meter so see if there are excessive voltage swings when a light or appliance (that is on that circuit) is turned on or off. If there is a 10 volt fluctuation of voltage measured, there may be too many appliances using that circuit.

NOTE:

A. Checking continuity:

Adjust the volt meter to "continuity" or "Ohms". Take one lead on the meter and place it on a wire. Take the other lead on the meter and touch it to the stove body (ground). If the meter zeros out, you have a short that needs to be repaired.

WIRING DIAGRAM: NATURALFIRE™

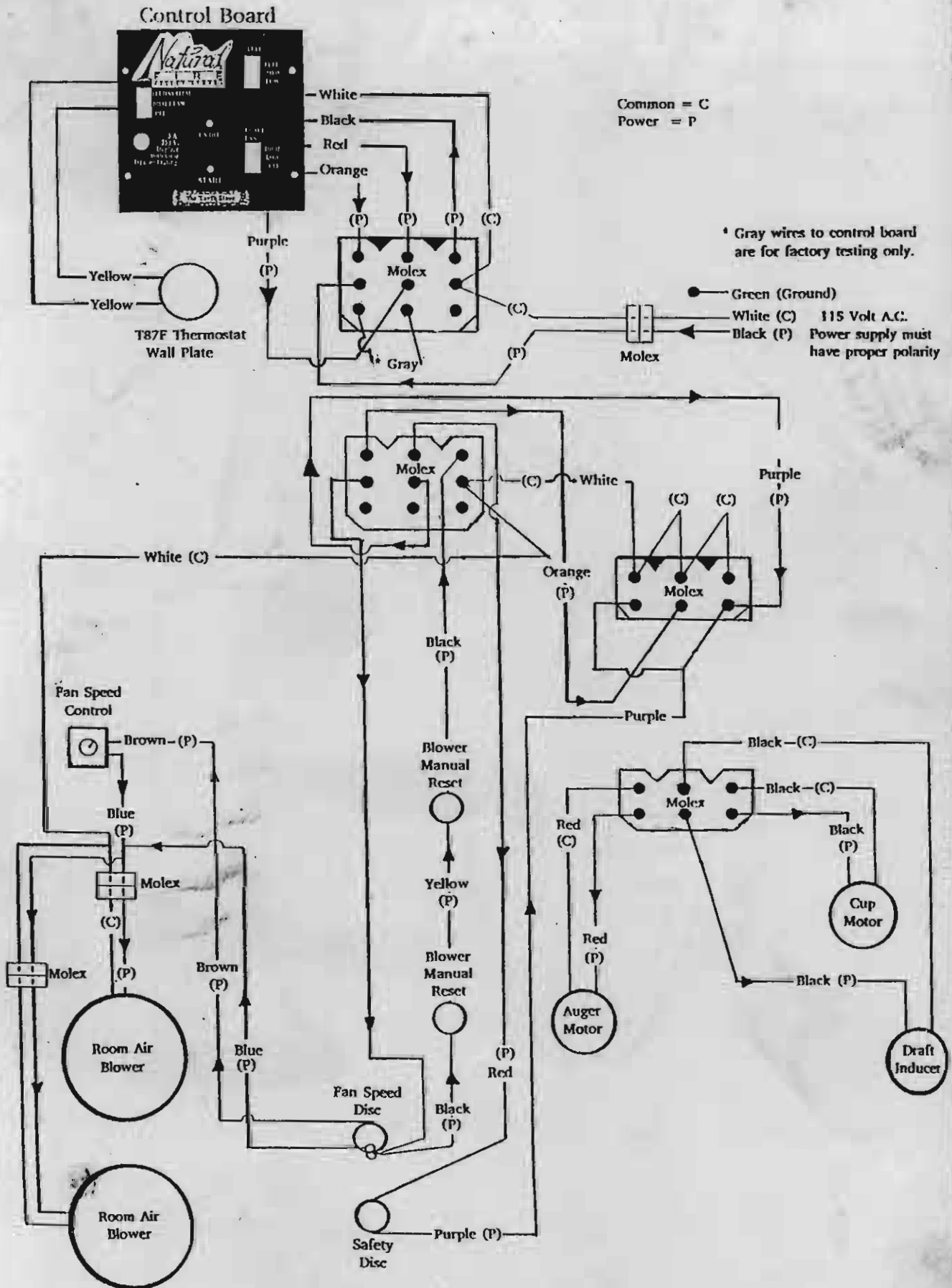

WARRANTY AND RETURN MERCHANDISE AUTHORIZATION PROCEDURE

CREDIT

Warranty claims can be handled by contacting your regional Warranty/Technical Support Department. When calling about a warranty claim, please have available the following information:

- | | |
|---------------------|------------------------|
| 1. Stove Model | 4. Customer Name |
| 2. Serial Number | 5. Problem Description |
| 3. Date of Purchase | |

RETURNING MERCHANDISE

Prior to returning any part(s), a Return Merchandise Authorization must be obtained by calling your regional Warranty/Technical Support Department. If these departments cannot take your call promptly, the Inside Sales Departments will help you. The defective merchandise must be returned within 30 days from the date authorized. Unless otherwise requested, return the defective part with the RMA number clearly marked on the outside of the carton and a completed warranty claim form, freight prepaid to:

The Earth Stove, Inc.
10595 S.W. Manhasset Street
Tualatin, Oregon 97062

After the defective part has been returned and found to be defective, a reimbursement will be issued on parts and labor (if applicable) to the dealer's account. Labor reimbursement for appliances in their first year of warranty, is listed under the Labor Reimbursement Schedule as shown on the warranty claim form. This reimbursement is automatic and does not need to be requested. To receive labor reimbursement credit for labor not listed, see instructions under Labor Authorization. Warranty claim forms submitted with incomplete information will be returned.

LABOR AUTHORIZATION

To receive credit for labor not listed on the labor reimbursement schedule, a Labor Authorization number must be obtained from your regional Warranty/Technical Support Department, prior to the work being done. This authorization expires 30 days from the date issued. Credit will be issued upon the return of a completed warranty claim form and a receipt showing labor charges. When calling about a Labor Authorization, please have the following information available:

- | | |
|---------------------|-----------------------------------|
| 1. Stove Model | 4. Customer Name |
| 2. Serial Number | 5. Labor Estimate (\$) |
| 3. Date of Purchase | 6. Description of work to be done |

MISC. WARRANTY

If a part is found to be defective within 90 days from the date of purchase, the warranty coverage is 100% for the part (no labor).

Note: With a little help from our Technical Representatives, most stoves can be "field fixed". We encourage you to call for assistance when questions arise. The Earth Stove, Inc. reserves the right to inspect all installations before the decision is made to remove a stove. If a stove is removed without written authorization from The Earth Stove®, you will forfeit your right to further assistance.



WARRANTY CLAIM FORM

To be reimbursed for any warranty work, please complete this form and submit with the defective part (s). Prior to returning any parts, obtain a Return Merchandise Authorization (RMA) from your regional Warranty & Technical Support Office. Authorization numbers expire 30 days from the date issued.

Return to:		RMA# _____
The Earth Stove, Inc.	Submitted By: _____	Labor Auth# _____
10595 S.W. Manhasset		
Tualatin, Or. 97062	Technician: _____	Account # _____
Phone (503) 692-3991 Fax (503) 692-6728		

Dealer Name

Address	City/State
Zip	Phone
	Fax

COMPLETE THE FOLLOWING IF WARRANTY SERVICE WORK HAS BEEN PERFORMED.

Model	Serial No.	Date of Purchase
Customer Name		Date of Service
Address		Phone No.
City/State		Zip
Description of problem and work performed:		

PART (S) DESCRIPTION	Invoice No. (if available)	√ Reason (1) Stove Warranty (2) 90 Day Parts Warranty (3) Other (please explain)
		(1) (2) (3 please explain)
		(1) (2) (3 please explain)
		(1) (2) (3 please explain)
		(1) (2) (3 please explain)

GAS APPLIANCE DIAGNOSTIC INFO. (required for return of gas valve) Natural Gas (LP) Propane

Millivolts (w/pilot only)	Millivolts (w/burner on)	Valve (TH/TP) Ohms	Valve (TP-TH/TP) Ohms
Shut down time	Manometer reading at valve	Air Shutter Opening Approx. (circle one) 13/64" 19/64" Full Open	

PELLET APPLIANCE DIAGNOSTIC INFO.

Draft Fan Voltage Test: High _____ v. Low _____ v. Feed _____ v.	Rheostat Voltage Test: High _____ v. Low _____ v.	Fuel Type: <input type="checkbox"/> Pellets <input type="checkbox"/> Corn Brand _____ Quality _____	Misc. Information:
---	---	---	--------------------

Labor Reimbursement Schedule

\$20.00	\$25.00	\$30.00	\$40.00
Burner Ignitor Misc. (Rheostats & Draft Modules)	Limit Disc Control Board R.B. Regulator Orifice Spill Switch	Circulation Blower Draft Inducer Cup/Auger Motor Valve	Auger Assembly

If work performed is not shown on Labor Schedule, call for Labor Authorization.

Above Labor Schedule is for first year warranty only.

**The Earth Stove®
NaturalFire™
Limited Warranty**

WHO IS COVERED:

The original purchaser.

WHAT IS COVERED:

100% of all parts to be free of defects in materials and workmanship (except marble and glass).

FOR HOW LONG:

One year from date of purchase.
Marble is covered for 90 days.
Glass is covered for 30 days.

ADDITIONAL COVERAGE:

Electrical parts are covered 100% for two years from date of purchase.

The stove body, door frame, and exchange tubes are covered year two through five at the current retail price at time of repair or replacement, according to the schedule below:

- Year 2 - 80% coverage
- Year 3 - 60% coverage
- Year 4 - 40% coverage
- Year 5 - 20% coverage

Year two through five coverage excludes:

- Gaskets/Rope
- Baffles
- Paint
- Logs
- Firepot

WHAT IS NOT COVERED:

- * The cost of inspection
- * Adjustments to the stove
- * Removal and reinstallation costs, shipping costs to and from factory and or authorized service center.
- * Shipping damage, improper handling, improper operation, misuse, abuse, neglect, accident, damage from improper installation, alteration, or unauthorized service.

ALL THE ABOVE MUST BE BORNE BY THE PURCHASER.

WHAT YOU MUST DO TO OBTAIN WARRANTY SERVICE:

Contact your selling dealer. Provide the following information to the dealer: Model number, Serial number, Date of Purchase, and Place of Purchase (if different).

OR

Prior to repair or replacement, send the defective part (Freight Prepaid) with the above information to:

The Earth Stove, Inc.
10595 SW Manhasset St.
Tualatin, OR 97062

IMPORTANT: THIS WARRANTY IS NOT VALID UNLESS:

The warranty registration card has been properly completed and returned within 30 days of purchase.

The defective stove or part(s) are promptly delivered, with ALL FREIGHT AND HANDLING CHARGES PREPAID, to The Earth Stove, Inc. or our authorized dealer from which the stove was purchased.

When returning parts for warranty, do not cut wires, alter or disassemble part(s).

The appliance must be installed by a Qualified Technician.

We shall not be liable for incidental or consequential damages or commercial loss, nor for any loss or damage except as set forth in this warranty.

This warranty gives you specific legal rights and you may have other rights which vary from state to state. Some states may not allow the limitations or exclusions set forth so the limitations or exclusions may not apply to you. No person is authorized to extend or enlarge any liability or obligation which we may have in connection with the sale of the stove.

RETAIN THIS FOR YOUR RECORDS

Model _____
* Serial Number _____
Dealer _____
Date of Purchase _____

- * Serial Number Locations
Freestanding - on the back, above motor cabinet
Insert - on the back, right hand motor cabinet

**The Earth Stove®
RP45
Limited Warranty**

WHO IS COVERED:

The original purchaser.

WHAT IS COVERED:

100% of all parts to be free of defects in materials and workmanship (except glass).

FOR HOW LONG:

One year from date of purchase.
Glass has a 30 day warranty.

ADDITIONAL COVERAGE:

Electrical parts are covered 100% for two years from date of purchase.

The stove body, door frame, and exchange tubes are covered year two through five at the current retail price at time of repair or replacement, according to the schedule below:

- Year 2 - 80% coverage
- Year 3 - 60% coverage
- Year 4 - 40% coverage
- Year 5 - 20% coverage

Year two through five coverage excludes:

- Gaskets/Rope Paint
- Baffles Firepot

OPTIONAL PARTS WARRANTY:

The following optional parts are covered 100% for 90 days from the date of purchase of the optional part:

- Room Air Fan Kit
- Room Air Fan Mounting Bracket
- Outside Air Kit

The Optional D.C. Conversion Kit is covered as follows:

The control board and the metering cup motor are covered 100% for 2 years from the date of purchase of the kit. All other components are covered for 1 year from the date of purchase of the kit.

WHAT IS NOT COVERED:

- * The cost of inspection
- * Adjustments to the stove
- * Removal and reinstallation costs, shipping costs to and from factory and/or authorized service center.
- * Shipping damage, improper handling, improper operation, misuse, abuse, neglect, accident, damage from improper installation, alteration, or unauthorized service.

WHAT YOU MUST DO TO OBTAIN WARRANTY SERVICE:

Contact your selling dealer. Provide the following information to the dealer, Model number, Serial number, Date of Purchase, and Place of Purchase (if different).

OR

Prior to repair or replacement, send the defective part (Freight Prepaid) with the above information to:

The Earth Stove, Inc.
10595 SW Manhasset Street
Tualatin, OR 97062

IMPORTANT: THIS WARRANTY IS NOT VALID UNLESS:

The warranty registration card has been properly completed and returned within 30 days of purchase.

The defective stove or part is promptly delivered, with **ALL FREIGHT AND HANDLING CHARGES PREPAID**, to The Earth Stove, Inc. or our authorized dealer from which the stove was purchased.

When returning parts for warranty, do not cut wires, alter or disassemble part(s).

The appliance must be installed by a **Qualified Technician**.

We shall not be liable for incidental or consequential damages or commercial loss, nor for any loss or damage except as set forth in this warranty.

This warranty gives you specific legal rights and you may have other rights which vary from state to state. Some states may not allow the limitations or exclusions set forth so the limitations or exclusions may not apply to you. No person is authorized to extend or enlarge any liability or obligation which we may have in connection with the sale of the stove.

RETAIN THIS FOR YOUR RECORDS

Model _____

*Serial Number _____

Dealer _____

Date of Purchase _____

ALL THE ABOVE MUST BE BORNE BY THE PURCHASER

* The serial number is located inside the hopper.

The Earth Stove®
Wood Burning Appliances
Limited Warranty

WHO IS COVERED:

The original purchaser.

WHAT IS COVERED:

100% of all parts to be free of defects in materials and workmanship (except marble and glass).

FOR HOW LONG:

One year from date of purchase.
Marble has a 90 day warranty.
Glass has a 30 day warranty.

ADDITIONAL COVERAGE:

The stove body, and door frame are covered in years two through five at the current retail price at time of repair or replacement, according to the schedule below:

Year 2 - 80% coverage
Year 3 - 60% coverage
Year 4 - 40% coverage
Year 5 - 20% coverage

Years two through five coverage excludes:

Gaskets/Rope
Baffles
Paint
Firebrick
Electrical Components

WHAT IS NOT COVERED:

- * The Catalytic Combustor (See below)
- * The cost of inspection
- * Adjustments to the stove
- * Removal and reinstallation costs, shipping costs to and from factory and or authorized service center.
- * Shipping damage, improper handling, improper operation, misuse, abuse, neglect, accident, damage from improper installation, alteration, or unauthorized service.

ALL THE ABOVE MUST BE BORNE BY THE PURCHASER

CATALYTIC COMBUSTOR

Refer to the combustor manufacturers' warranty information provided with the stove.

WHAT YOU MUST DO TO OBTAIN WARRANTY SERVICE:

Contact your selling dealer. Provide the following information to the dealer, Model number, Serial number, Date of Purchase, and Place of Purchase (if different).

OR

For inspection prior to repair or replacement, send the defective part (Freight Prepaid) with the above information to:

The Earth Stove, Inc.
10595 SW Manhasset St.
Tualatin, OR 97062

IMPORTANT: THIS WARRANTY IS NOT VALID UNLESS:

The warranty registration card has been properly completed and returned within 30 days of purchase.

The defective stove or part is promptly delivered, with ALL FREIGHT AND HANDLING CHARGES PREPAID, to The Earth Stove, Inc. or our authorized dealer from which the stove was purchased.

When returning parts for warranty, do not alter or disassemble part(s).

The appliance must be installed by a Qualified Technician.

We shall not be liable for incidental or consequential damages or commercial loss, nor for any loss or damage except as set forth in this warranty.

This warranty gives you specific legal rights and you may have other rights which vary from state to state. Some states may not allow the limitations or exclusions set forth so the limitations or exclusions may not apply to you. No person is authorized to extend or enlarge any liability or obligation which we may have in connection with the sale of the stove.

RETAIN THIS FOR YOUR RECORDS

Model _____

* Serial Number _____

Dealer _____

Date of Purchase _____

* Serial number locations:

Freestanding - on the rear heat shield

Insert - on the right hand side of the outer firebox cabinet which recesses into fireplace.

The Earth Stove®
Gas Appliance
Limited Warranty

WHO IS COVERED:

The original purchaser.

WHAT IS COVERED:

100% of all parts to be free of defects in materials and workmanship (except marble and glass).

FOR HOW LONG:

One year from date of purchase.

Optional parts have a 90 day warranty.

Glass has a 30 day warranty.

ADDITIONAL COVERAGE:

The stove body and door frame is covered in years two through five at the current retail price at time of repair or replacement, according to the schedule below:

- Year 2 - 80% coverage
- Year 3 - 60% coverage
- Year 4 - 40% coverage
- Year 5 - 20% coverage

Year two through five coverage excludes:

Gaskets/Rope	Thermopile	Fan override disc
Baffles	Burner	Log Racks
Paint	Ignitor	Wiring
Logs	Spill Switch	On/Off Switch
Valve	Orifices	
R.B. Regulator	Heat Exchanger	

WHAT IS NOT COVERED:

- * The cost of inspection
- * Adjustments to the stove
- * Removal and reinstallation costs, shipping costs to and from factory and/or authorized service center.
- * Shipping damage, improper handling, improper operation, misuse, abuse, neglect, accident, damage from improper installation, alteration, or unauthorized service.

ALL THE ABOVE MUST BE BORNE BY THE PURCHASER

WHAT YOU MUST DO TO OBTAIN WARRANTY SERVICE:

Contact your selling dealer. Provide the following information to the dealer, Model number, Serial number, Date of Purchase, and Place of Purchase (if different).

OR

For inspection prior to repair or replacement, send the defective part (Freight Prepaid) with the above information to:

The Earth Stove, Inc.
10595 SW Manhasset St.
Tualatin, OR 97062

IMPORTANT: THIS WARRANTY IS NOT VALID UNLESS:

The warranty registration card has been properly completed and returned within 30 days of purchase.

The defective stove or part is promptly delivered, with **ALL FREIGHT AND HANDLING CHARGES PREPAID**, to The Earth Stove, Inc. or our authorized dealer from which the stove was purchased.

When returning parts for warranty, do not cut wires, alter or disassemble part(s).

The appliance must be installed by a Qualified Installer in accordance with the instructions.

We shall not be liable for incidental or consequential damages or commercial loss, nor for any loss or damage except as set forth in this warranty.

This warranty gives you specific legal rights and you may have other rights which vary from state to state. Some states may not allow the limitations or exclusions set forth so the limitations or exclusions may not apply to you. No person is authorized to extend or enlarge any liability or obligation which we may have in connection with the sale of the stove.

RETAIN THIS FOR YOUR RECORDS

Model _____

* Serial Number _____

Dealer _____

Date of Purchase _____

* The serial number is located on the rear panel.

WESTWAY INDUSTRIES, INC.

P.O. Box 68210 Portland, OR 97268
 711 S.E. Ankeny Portland, OR 97214
 Phone: (800)962-9191 Fax: (503)231-7832

FLEXIBLE METAL HOSE

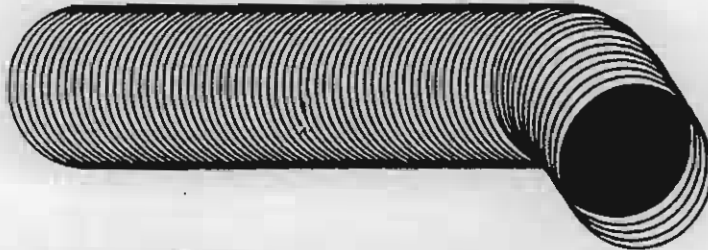

THIS LIGHTWEIGHT FLEXIBLE TUBING IS MANUFACTURED FOR USE
 IN THE INSTALLATION OF PELLET AND WOOD STOVES.

GALVANIZED CARBON STEEL

PART NUMBER	SIZE	PRICE/FT
G10-1500	1 1/2"	1.11
G10-1625	1 5/8"	1.19
G10-1750	1 3/4"	1.19
G10-2000	2"	1.29
G10-2500	2 1/2"	1.49
G10-3000	3"	1.95
G10-4000	4"	2.54
G15-5000	5"	2.82
G18-6000	6"	3.64
G18-7000	7"	4.15
G18-8000	8"	4.64
G18-10000	10"	5.08

STAINLESS STEEL

PART NUMBER	SIZE	PRICE/FT
S10-2000	2"	3.35
S10-2500	2 1/2"	4.15
S10-3000	3"	5.03
S10-4000	4"	6.54
S15-5000	5"	7.57
S18-6000	6"	9.27
S18-7000	7"	10.73
S18-8000	8"	12.19
S18-10000	10"	15.17

STANDARD LENGTHS ARE 25 FEET

SIZES 4" AND SMALLER WILL SHIP REGULAR UPS

ALUMINIZED CARBON STEEL TUBING MENDERS

PART NUMBER	SIZE	PRICE
TM-3000	3"	5.00
TM-4000	4"	6.00