

CAMP  CHEF

OWNER'S MANUAL

MODEL PG24HG | PG36HG

A MAJOR CAUSE OF FIRES IS FAILURE TO MAINTAIN REQUIRED CLEARANCES (AIR SPACES) TO COMBUSTIBLE MATERIALS. IT IS OF UTMOST IMPORTANCE THAT THIS PRODUCT BE INSTALLED ONLY IN ACCORDANCE WITH THESE INSTRUCTIONS.

IMPORTANT SAFETY WARNINGS

READ AND FOLLOW ALL INSTRUCTIONS BEFORE INSTALLING AND USING THE APPLIANCE

Please read this entire manual before installation and use of this pellet fuel-burning appliance. Failure to follow these instructions could result in property damage, bodily injury, or even death. Contact local building or fire officials about restrictions and installation inspection requirements in your area. **SAVE THESE INSTRUCTIONS.**

TO INSTALLER OR PERSON ASSEMBLING THIS APPLIANCE:

Leave this manual with this appliance for future reference.

TO CONSUMER: Keep this manual with this appliance for future reference.

This instruction manual contains important information necessary for the proper assembly and safe use of this product.

▲ WARNING: FOR OUTDOOR USE ONLY

▲ CARBON MONOXIDE WARNING

Follow these guidelines to prevent this colorless, odorless gas from poisoning you, your family or others:

- Know the symptoms of carbon monoxide poisoning: headache, dizziness, weakness, nausea, vomiting, sleepiness, and confusion. Carbon monoxide reduces the blood's ability to carry oxygen. Low blood oxygen levels can result in loss of consciousness and death.
- See a doctor if you or others develop cold or flu-like symptoms while cooking or in the vicinity of this appliance. Carbon monoxide poisoning, which can easily be mistaken for a cold or flu, is often detected too late.
- Alcohol consumption and drug use increase the effects of carbon monoxide poisoning.
- Carbon monoxide is especially toxic to mother and child during pregnancy, infants, the elderly, smokers and people with blood or circulatory system problems, such as anemia, or heart disease.

▲ WARNING

CLEANING:

- Normal use will create a buildup of ash, grease, and creosote inside the grill. The grill must be thoroughly cleaned after every 50 hours of use or if a buildup of grease or creosote is noticed inside the grill.
- Clean the grill by removing all internal parts and thoroughly scrape away all grease and creosote from all internal surfaces, including the grease drain, and remove debris from the grill.
- The drip tray must always be cleaned prior to turning the grill to high.

▲ DANGER

FIRE HAZARD:

- Never operate this appliance unattended.
- Never operate this appliance within 10 ft (3 m) of a stored LP cylinder.
- Never operate this appliance within 25 ft (7.5 m) of any flammable liquid.
- If a fire should occur, keep away from appliance and immediately call your fire department. Do not attempt to extinguish an oil or grease fire with water.
- Minimum distance from sides and back of the unit to walls or railings is 36".
- Do not operate under overhead construction.

▲ DANGER

ELECTRIC SHOCK:

- Do not work on this grill if it is plugged in. Electric shock may occur resulting in death or serious injury.

Excessive buildup of grease and creosote may result in a grease fire. If a grease fire does occur, turn off the grill using the main power switch and close the lid. Leave the lid closed until the fire extinguishes itself. If an uncontrolled fire does occur, immediately call the local fire department.

- Never put water on a grease fire.
- Never open the burner clean-out port when the grill is hot.

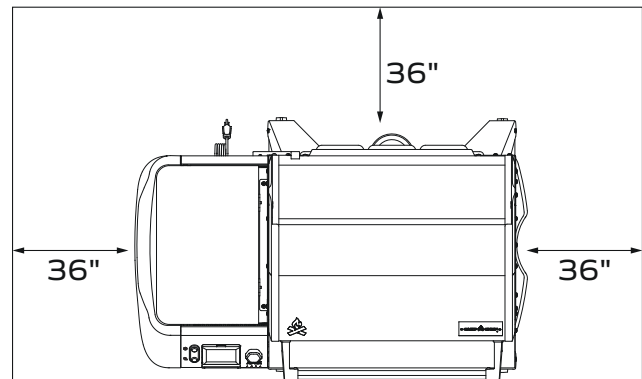

SAVE THESE INSTRUCTIONS

GENERAL WARNINGS

PRE-USE INSPECTION:

- Do not operate appliance under ANY overhead construction. Keep a minimum clearance of 36 inches (0.9 m) from the sides, front and back of appliance to ANY construction. Keep the area clear of all combustible material and flammable liquids, including wood, dry plants and grass, brush, paper, and canvas.
- Use only on a level, stable non-combustible surface like bricks, concrete or dirt. Do not use this appliance on any surface that will burn or melt like wood, asphalt, vinyl or plastic.
- Make sure burner clean-out is closed before starting the grill.
- Make sure the grease bucket is in place before starting the grill.

OPERATION:

- Do NOT leave this appliance unattended while in use. The user must remain in the immediate area of the product and have a clear view of the product at all times during operation.
- Keep children and pets away from burner at all times.
- The use of alcohol, prescription or non-prescription drugs may impair your ability to properly assemble or safely operate this appliance.
- For OUTDOOR use only. Do NOT use in a building, garage or any other enclosed area. Do NOT use in or on recreational vehicles or boats. NEVER use this appliance as a heater.
- Keep the lid closed during cooking.
- In the event of a fire the dial should be turned to shutdown, close the lid, and leave it closed until the fire goes out. After allowing the grill to cool, follow the cleaning instructions before the next use.
- Do not use accessories not specified for use with appliance.
- Never use gasoline, gasoline-type lantern fuel, kerosene, charcoal lighter fluid, or similar liquids to start or freshen up a fire in this appliance. Keep all such liquids well away from the appliance when in use.
- This product is not intended for commercial use.

PELLETS:

- Use only food grade hardwood pellets manufactured for use in pellet grills. Using softwood or heating pellets will void your warranty.
- It is recommended that you not store pellets in the hopper for extended periods as they may absorb moisture from the air and clog the auger.
- Do not allow the hopper to run out of pellets. Pellets can be added at any time. The hopper will hold approximately 22 pounds of pellets. The pellet usage will vary greatly depending on the ambient temperature as well as cooking temperature.

CLEANING:

- Creosote – Formation and need for removal. When wood pellets are burned slowly, they produce tar and other organic vapors that combine with expelled moisture to form creosote. The creosote vapors condense in a relatively cool oven flue and exhaust hood of a slow burning fire. As a result, creosote residue accumulates on the flue lining and exhaust hood. When ignited, this creosote makes an extremely hot fire. The grease duct should be inspected every 50 hours of cooking to determine when grease and/or creosote build-up has occurred. When grease or creosote has accumulated, it should be removed to reduce risk of fire.
- Ashes should be placed in a metal container with a tight fitting lid. The closed container of ashes should be placed on a non-combustible floor or on the ground, well away from all combustible materials, pending final disposal. When the ashes are disposed by burial in soil or otherwise locally dispersed they should be retained in the closed container until all cinders have thoroughly cooled.

STORAGE:

- Always allow the appliance to cool before covering with the cover.
- Always cover the appliance, with cover (if supplied), when not in use.
- Always unplug grill before installing patio cover.

WELCOME TO THE FAMILY

Being a part of the Camp Chef family means more than just using our products, it also provides a sense of community. We know every good time starts with an invitation, and there's no better enticement than great-tasting food. And the best food, we believe, is cooked with a flame and kissed by smoke.

Grab a drink and stay a while... we've got brisket on.

TABLE OF CONTENTS

Safety Warnings

General Warnings

Welcome to the Family

Special Features

Connecting your WiFi Controller

Grill Operation - First Time

Grill Operation

Maintaining your Grill

FAQs

Troubleshooting

Replacement Parts

Service and warranty







HYBRID GRILL COMPATIBLE

The APEX combines the best of the ever popular wood pellet grill with the time-tested option of using propane to get the job done quickly. In one unit, and in a single chamber, a griller will be able to easily switch fuel sources. So whether it's a quick cook of grilled chicken or a well-earned smoke ring on a brisket, it will be grilling like never before.

The purchase of the gas train / sidekick accessory is required for propane grilling. Learn more at www.CampChef.com/Apex.

▲ Use of both pellet and propane fuel sources at the same time is absolutely prohibited.



WIFI CONTROLLER

The APEX comes standard with a full color screen controller and four meat probe ports. Monitor the grill and food contents using a smart phone and the Camp Chef Connect app. Set timers, change temperature settings, and even tailor smoke levels from 1-10 using Smoke Control.



SIDE ATTACHMENT COMPATIBLE

Install the gas train and SIDEKICK APX attachment and open the award winning capabilities of Camp Chef's Sidekick system— Sauté on the griddle, bake within the pizza oven, sear on the grill box, boil with a stock pot—the menu possibilities are endless. It truly is the definition of versagrillity.

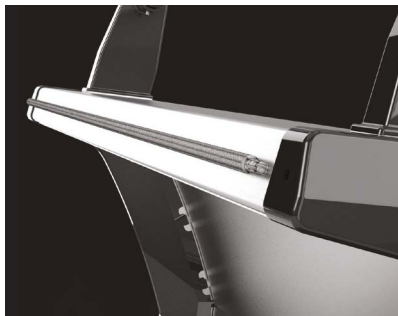

PROGRESSIVE HEAT DESIGN

Once the hardwood pellets are burned, heat is directed to each side of the grill enveloping the entire chamber with consistent temperatures. The smoke then rises to the top and rolls back to the bottom before exiting the Rear Ventilation System. All of this is retained with double-walled construction and a lid gasket to create a quality cooking experience.

1. Side-to-side heat distribution
2. Rear ventilation system
3. Double-walled construction
4. Lid Gasket



SMOKE CONTROL

Control exactly how much smoke you incorporate into your cook by adjusting the Smoke Number. The PID controller gives you the industry's most precise grill temperature. As your Smoke Number increases, your smoke output increases. As your Smoke Number decreases the temperatures will hold tighter.

SPECIAL FEATURES



ASH CLEAN OUT SYSTEM

Unlike other pellet grill companies, our Ash Clean out System allows for the user to easily clean out the burn cup and dispose of the ashes. Before each cook, simply pull the lever and dump out the ash — it's that easy. To learn more see page 19.



PELLET LEVEL SENSOR

Get notified when you're running low on pellets. Enable app notifications to remind you when to fill up. Must have the Camp Chef Connect App.



INTERNAL CHAMBER LIGHT

Early morning and late night smokes call for an extra set of hands to hold the flash light. Push the button to the left of the controller to illuminate your grill contents and shed some light on the subject.



PROBE STORAGE COMPARTMENT

Store your meat probes in this sleek and convenient compartment. Push to open.

WIFI CONTROLLER



CONTROLLER FUNCTIONS

Rotate the dial to scroll through menus, adjust temperatures, or smoke settings. Press the dial to select.

Set temperature:

Use this setting to set your temperature (160 - 400 °F). Rotate the dial to the desired temperature and press to confirm.

Bypass:

Use bypass in the case of power failure/accidentally outage or you need to restart the grill and it is still hot. Use only if grill has been off for less than 3-4 minutes. This method is used to bypass the normal startup, ignite new pellets, and get back to cooking. BYPASS can be selected during the initial startup of the grill only by selecting BYPASS from the STARTUP screen. If the grill fails to ignite using the bypass mode then restart the grill using the normal startup procedures.

Fan only:

Use this setting when using a smoke tube for cold smoking.

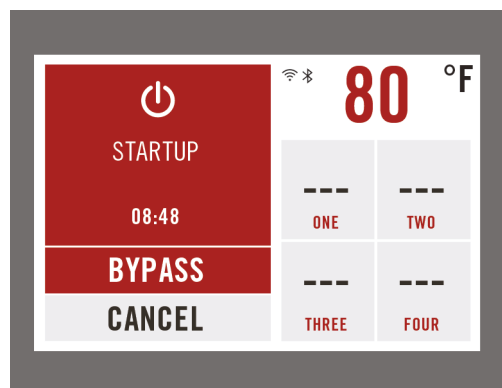
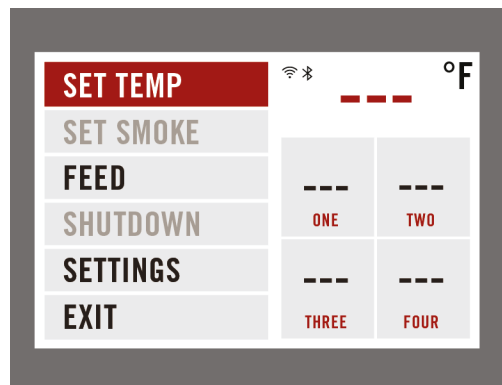

WIFI CONTROLLER

Set smoke level:

Use this setting to adjust the smoke level. Rotate dial to the desired smoke setting and press to confirm. The smoke setting can be adjusted from 1-10.

▲ Only available from 160 - 350°F

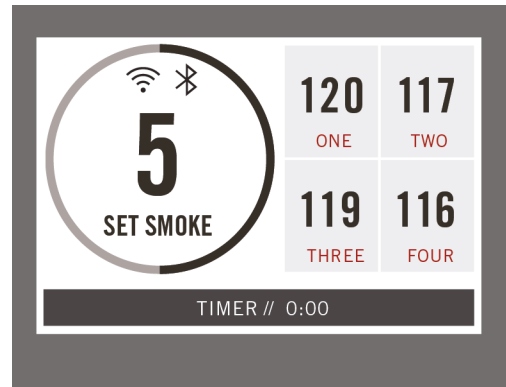
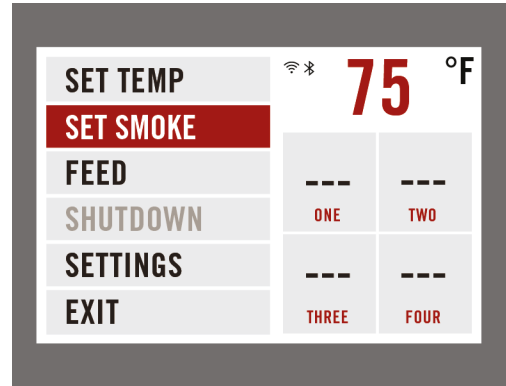

A smoke setting of 1 will produce less smoke and maintain a more even temperature. As the smoke setting increases, the temperature fluctuations will also increase.

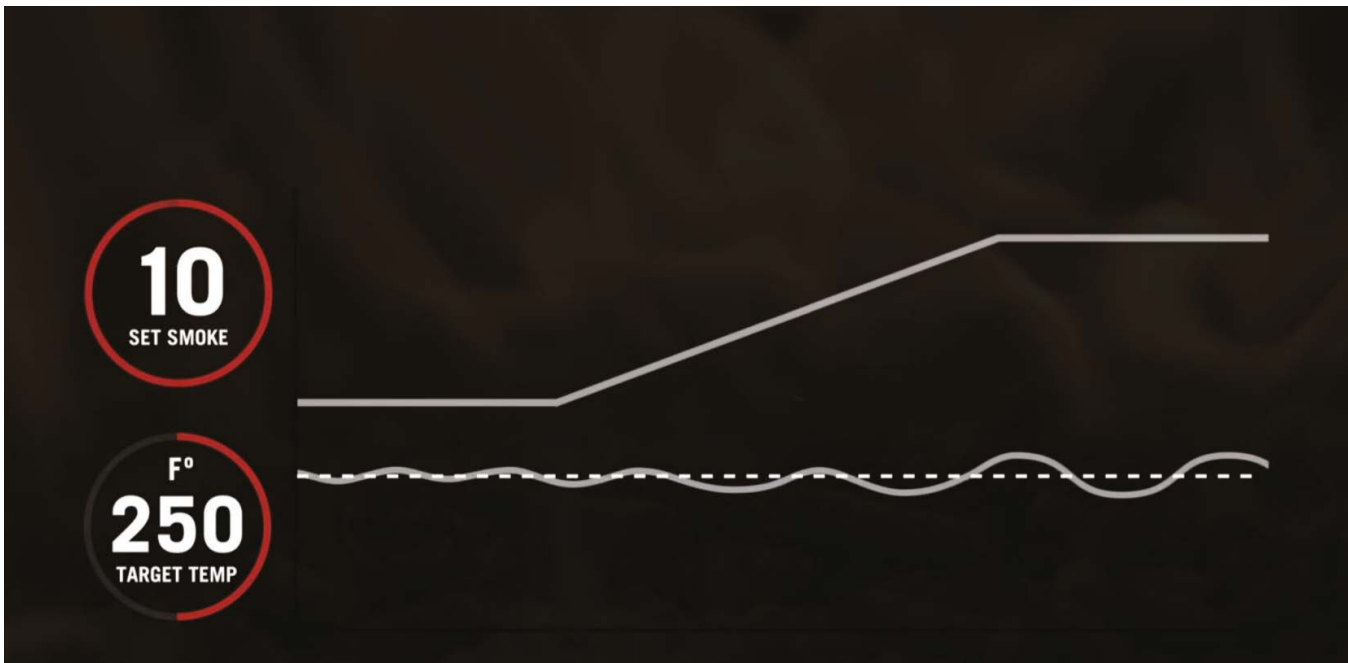

Feed:

This setting is used to feed pellets to the burner and should only be used in the following scenarios:

1. The first time you use the grill to fill the auger tube.
2. Anytime you inadvertently run the hopper out of pellets or if you want to change pellet variety.

Once the FEED cycle has finished, the controller will return to the main menu and the auger tube will be filled with pellets. You are now ready to start cooking.

⚠ Do not over-fire the grill by over feeding pellets into the burner prior to startup. If flame is inadvertently extinguished never restart the grill without first cleaning out the burner. Improper use can cause an uncontrolled fire.

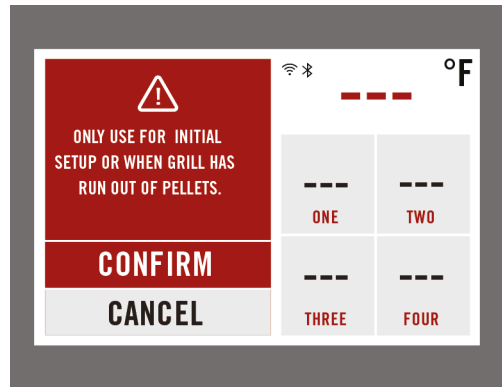
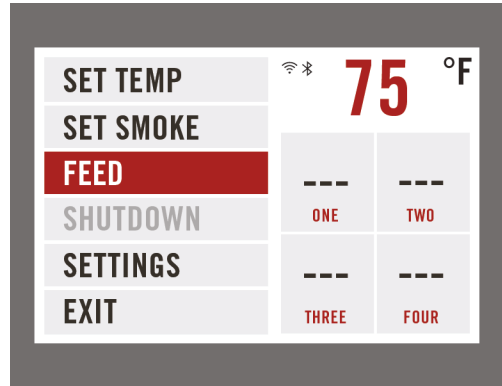

Shutdown:

Use this setting when you are finished with your cook. The fan will remain on for up to 20 minutes. This setting will burn up any extra pellets in the burner and cool down the grill. After 20 minutes the display screen will turn off and the grill can be unplugged.

- ⚠ *This setting must be used after each use.*
- ⚠ *Do not turn the main power switch off when the grill is hot.*
- ⚠ *In event of a grease fire, do not use the shutdown mode. Turn the grill off and use a fire extinguisher.*

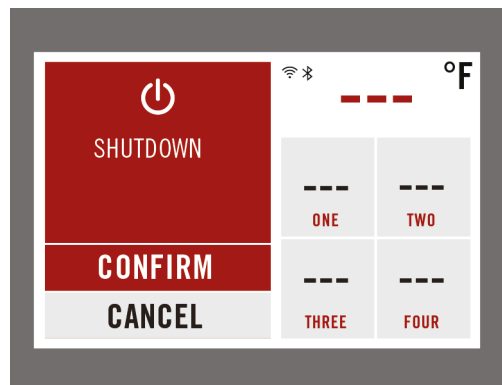
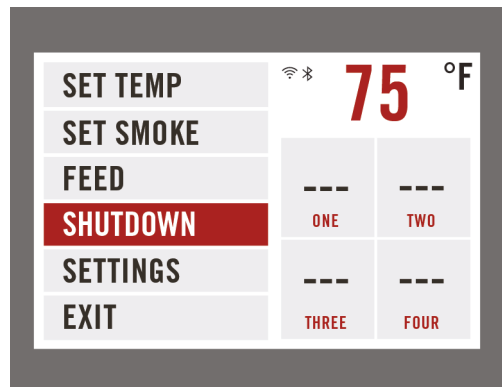

CAMP CHEF CONNECT APP



CAMP CHEF CONNECT APP

With our innovative PID and WIFI enabled controller, stay connected to your grill using the Camp Chef app.

Getting started:

1. Download the Camp Chef Connect app from the Apple app store or Android Play store.



2. Allow for notifications. Certain features, like the pellet sensor, are only available on the app.
3. Turn the grill controller on using the main power switch on the controller.
4. Open the Camp Chef Connect app and follow the setup instructions for connecting the grill to your home 2.4GHz WiFi network.

For safety reasons, you are only able to start the grill from the controller and not through the app. If you attempt to start the grill from the app, it will prompt you to start the grill from the controller.

CAMP CHEF CONNECT APP FUNCTIONS

The Camp Chef Connect app lets you do everything the controller can do and more.

Probes:

Your grill comes with four probe ports. Organize your probes by naming them within the app and assigning them target temperatures. (Yes, we'll even send you notifications when they get close!)

⚠ Do not use meat probes when grill temperature exceeds 350°F. Damage to the probes may occur.

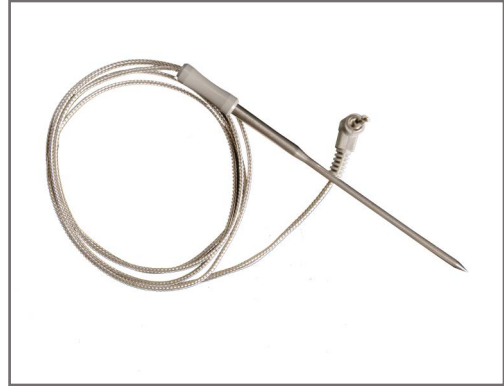

Temperature graphing:

View historical data from your cooks along with temperature changes over time from both your meat probes and your grill. Graphs can be customized to show different data and time intervals. Add notes to your past cooks and use them for future smokes.

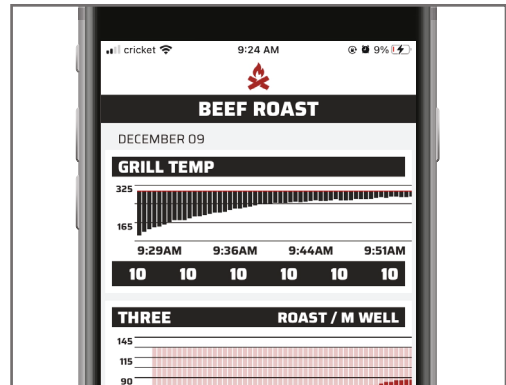

Timers:

Create a list of timers to remind you to check your grill at important intervals. Timers are persistent and can be easily used across different cooks. This can be extremely helpful in multi-stage smokes like ribs or brisket.

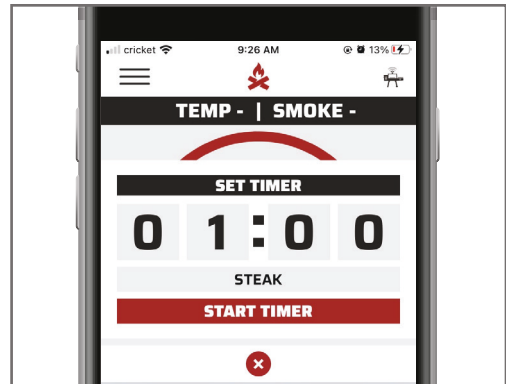

Smart Meat Assistant:

Choose from a variety of temperature presets for different meats. Set probe names and goal temperatures. You'll even be notified when your cook has reached its desired level such as rare or well-done.

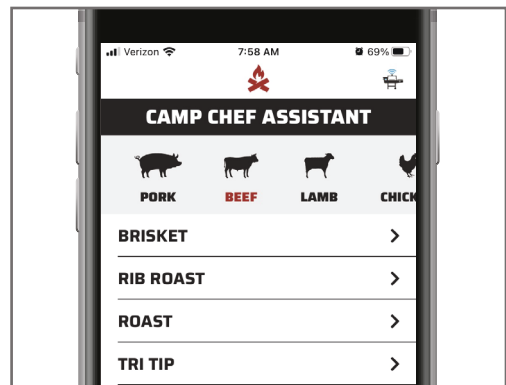



GRILL OPERATION - FIRST TIME

BEFORE YOU TURN YOUR GRILL ON

Make sure the grill is a minimum of 36" from all combustibles. Use on a level, stable non-combustible surface. Do not use this pellet grill on any surface that will burn or melt. Do not operate under any overhead construction.

Make sure the burner clean-out cup is emptied and closed before starting the grill.

Make sure the ash cup and grease bucket are in place.

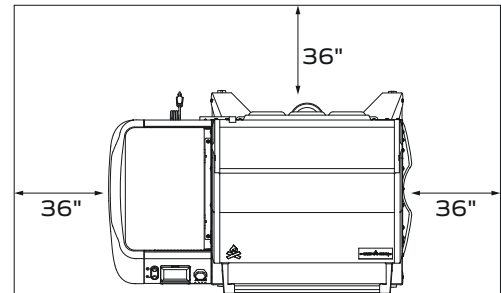

GETTING STARTED:

1. Plug your grill into an outlet.
2. Fill the hopper with pellets.
3. Select FEED mode and allow the feed cycle to finish running. Once the feed cycle has finished, the controller will return to the main menu. See page 13.

Empty out the burn cup by pulling the clean-out knob on the front of the grill. Excess pellets from the feed cycle must be emptied before starting your grill and beginning your initial burn-in.

INITIAL BURN-IN

Before you start your first cook, season your pellet grill by following these instructions:

1. Open the lid of the pellet grill and leave open during the entire startup cycle.
2. Select SET TEMP from the main menu and set the temperature to 350°F.
3. Once the startup cycle is finished, close the lid and allow the grill to cook for 30 minutes at 350°F.
4. Select SHUTDOWN from the main menu

During SHUTDOWN the fan will remain on for 20 minutes to finish burning any pellets in the burn cup and cool the grill down. After 20 minutes the screen will turn off and the grill can be unplugged.

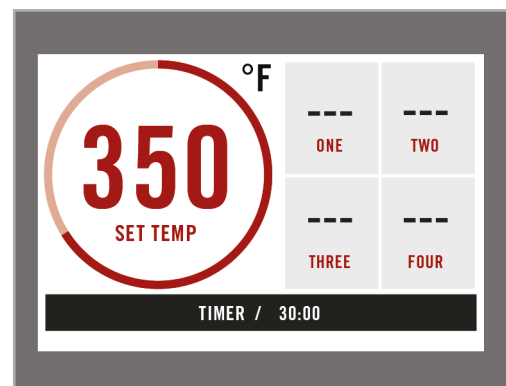

GRILL OPERATION

START UP

Now that your pellet grill has been properly seasoned, you are ready to start your wonderful relationship with your new grill. Follow these instructions every time you operate your grill:



1. Ensure the hopper is filled with premium, food grade hardwood pellets.



2. Ensure the grease tray is clean and in place.



3. Pull the clean-out knob on the front of the grill and empty out any ash that may have been left in the burn cup from the last cook.



4. Replace ash cup and close the ash clean-out by pushing the knob back in and securing it under the locking collar.



5. Plug your grill into an outlet and turn it on by pressing the power button. Note: Button depressed = on. Button raised = off.

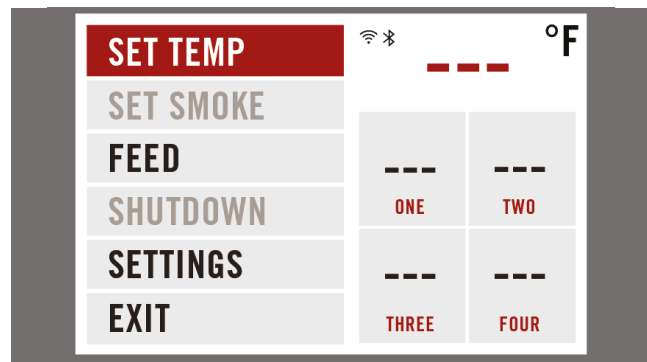

6. Select SET TEMP and set your temperature.

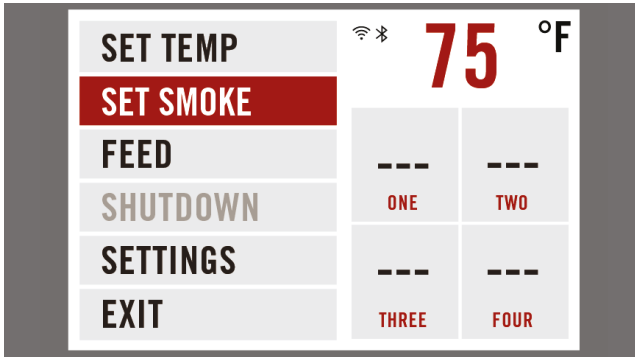

7. Select SET SMOKE and set your smoke number. *Only available from 160°F - 350°F.*



8. Open the lid of the pellet grill and leave open during the entire startup cycle.



9. When the startup cycle is finished the controller will display the temperature and the lid can be closed, allowing the pellet grill to reach and maintain the set temperature.

GRILL OPERATION

COOKING

It's time to start cooking! Visit www.campchef.com/recipes for some great recipe ideas on what to do for your first cook.



10. Place your food on the grill.



11. Plug the probe into one of the four available ports on the grill faceplate.



12. Insert the probe and wire through the stainless flap on the side of the chamber.



13. Insert the probe into the food you want to monitor. Make sure to insert the probe tip into the thickest part of the meat and not touching any bone.

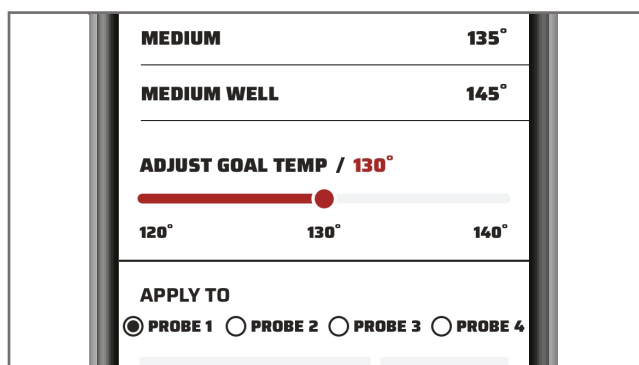

14. Select your probe on the controller or on your Camp Chef app and set an alarm at your desired temperature.

SHUTDOWN

Use the SHUTDOWN option every time you are finished with your cook.

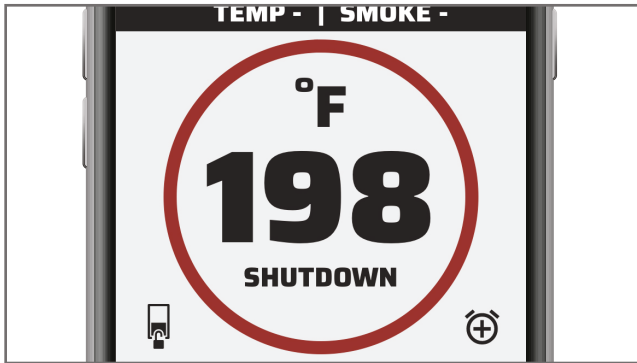

16. Select SHUTDOWN from the main menu. In this setting the fan will remain on for 20 minutes to finish burning any pellets in the burn cup.

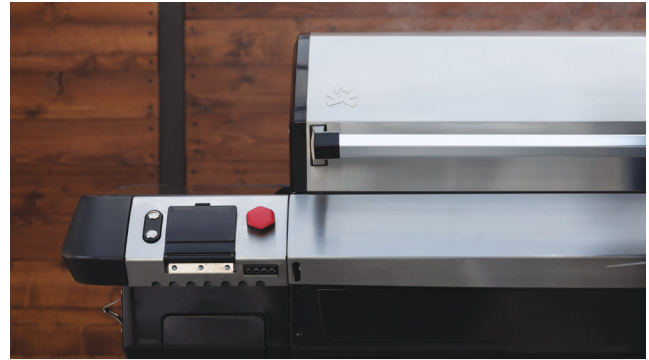

17. After 20 minutes the grill will turn off.



18. Unplug the grill and store the cord on the back bracket.

GRILL MAINTENANCE

If you've got yourself a pellet grill, you're probably enjoying a steady stream of incredible food, whether it's fresh-baked pizza or smoked brisket. But with each cookout, your grill collects a little more grease and ash. To keep your "grillfriend" at its best, ready to cook all your favorite foods, follow our cleaning guide below.

BETWEEN EACH COOK:

For quick cleanup between cookouts, you don't need to do anything too dramatic. In fact, our patented Ash Clean-out system makes it as simple as pulling a knob. Before you fire up the grill each time, just empty the ash into the cup, and you're good to go. It's almost too easy.



Disposing of ash:

If the ash is completely cool, it can be wrapped up in aluminum foil and tossed in the garbage.

▲ Never dispose of hot ashes. Allow them to cool before proper disposal.

Don't forget about the internal temperature probe. You'll want to clean it between each cook. It's located in the center of the cooking chamber, near the top and is about the size of a pencil. Our goal is to keep it looking silver. To do this mix a vinegar/water solution and use a scouring pad. Often times if your temperature does not read accurately it's because too much smoke has been built up.

Besides emptying the burn cup, you may want to spot clean between cook sessions as well. This can be as simple as wiping away grease spots or food residue on the lid or side shelf. You should also scrape down the grill grates with a wire grill brush or spatula before you start cooking to avoid a burnt taste on your food.

Open the grease tray door and ensure the grease tray is free from grease buildup. To avoid flare-ups in the grill, use a spatula to remove any grease from tray. Ensure the drain hole and grease drain are not blocked.

Tip: Scrape your grates with a wire brush after every cook while the grates are still warm.

▲ Don't burn yourself if your grill is still hot.

Cleaning meat probes:

Clean your probes after each use. Use warm soapy water and a cloth or paper towel. **▲ Do not submerge wire in water. Not dishwasher safe.**

If you take these small steps toward keeping your pellet grill clean, any deeper cleaning you do will be much easier.

AFTER 50 HOURS OF COOKING:

You should give your grill a deep clean roughly every 50 hours of cooking. If you don't cook on your pellet grill very often (you should fix that), you may only need to deep clean your grill once every several months. Be sure to clean the internal temperature probe and dump the ash cup like in the step previous. If you're a pellet head like we are at Camp Chef, you'll find yourself doing this routine more often. Luckily, it's quite simple.

Cleaning the exterior:

▲ Safety first! Make sure your grill is totally cool, then unplug it from its power source.



Empty the pellet hopper to prevent your pellets from getting wet or coming into contact with cleaning substances.

Spray stainless steel cleaner on the painted or stainless steel surfaces of your grill. Avoid spraying any plastic components. (You can also use hot, soapy water-it just may not work as quickly!)

▲ Do not use oven cleaner, abrasive cleaners, or abrasive cleaning pads on the exterior surfaces of your grill.

Let the cleaner sit for about 30 seconds to give it a chance to break down grease and smoke stains.

Wipe off the cleaner with a clean paper towel or rag. Wipe with the grain if you're cleaning stainless steel or in circles, if you're cleaning a painted surface.

Repeat the process once more to clean off any remaining grease or smoke. With a rag, rinse thoroughly if you used soapy water.

Cleaning the interior:

▲ Safety first! Make sure your grill is totally cool, then unplug it from its power source.

Empty the pellet hopper to prevent your pellets from getting wet or coming into contact with cleaning substances.

Pull the Ash Clean-out knob and empty the ash from the burn cup.

Open the lid and remove the cooking grate, any extra racks, drip tray, and heat diffuser plate from inside the grill. Pay attention to how these pieces are installed (or even take a picture) so you'll have an easier time reassembling your grill.

Use a wet/dry vacuum with a hose attachment to remove loose ash and debris.

Remove creosote buildup from updraft walls.

Look for places inside your grill where grease has built up. Use something with a flat edge (a paint stick, pan scraper, etc.) to dislodge and remove it.

Use hot, soapy water and a rag to wash the interior of your grill, as well as each piece you pulled out.

Repeat the process until most of the grease buildup is gone.

With a rag, rinse thoroughly if you used soapy water and allow everything to dry.

▲ NEVER cover slots, holes, or passages in the grill bottom or cover an entire rack with material such as aluminum foil. Doing so blocks air flow through the grill and may cause carbon monoxide poisoning. Aluminum foil linings may trap heat causing a fire hazard.

Tip: Use our grease bucket liners to make cleaning your grease bucket a snap.

Allow to dry for at least 24 hours before cooking,

and double-check that the hopper has no water in it before reloading pellets.

Cleaning the exhaust vents:

When wood pellets are burned slowly, they produce tar and other organic vapors that combine with expelled moisture to form creosote. The creosote vapors condense on cooler areas of your grill, like your exhaust vents. When ignited, creosote can produce an extremely hot fire and damage property or the exterior finish of your grill. Creosote and grease should be removed to reduce the risk of fire.

Remove the bolts on either side of the vents on the back of your grill. From the inside of your grill, remove the vent cover that is now loose. Remove any grease or creosote buildup and replace the cover.

Dedicating a bit of time to cleaning out your pellet grill, both between cooks and a couple of times a year, will keep the good food coming for years. When you love your grillfriend, it will love you back.

Let us know if you have any pro cleaning tips by sharing it with everyone on our social media.

Pellet storage:

Store pellets indoors in a dry space away from humidity, moisture fluctuation, and heat producing appliances. If your pellet grill ever isn't running properly, pellets are the first thing to check.

The use of Camp Chef pellets is recommended but not required. Camp Chef pellets are 100% hardwood, non-toxic and contain no oils, chemicals, or added binders.

FREQUENTLY ASKED QUESTIONS

<p>Do you need to use pellets all the time? Even if you are not wanting to smoke the food?</p>	<p>Pellets are the main source of fuel on this pellet grill. If you add the gas train/ sidekick accessory, you can add the option of cooking with propane as well.</p>
<p>Can I use other brands of pellets?</p>	<p>Yes, however some flavors and brands of pellets burn differently than others. You will want to use 100% all natural wood pellets with no additives, binders, glue, corn, or any other oils.</p>
<p>How long do you want to run the smoker before you can cook on it?</p>	<p>You will want to go through the full startup process with the lid up. You can put the lid down once there is a temperature displayed on the controller. From there, wait until it gets up to the desired temperature and then you are good to put your food in and start your cook.</p>
<p>How long does it take the grill to start up?</p>	<p>The startup process for the grill is about 6 minutes to ignite the pellets. From there it will take 10-20 minutes to get up to the desired temperature. The hotter the temperature, the longer it can take. Please note that colder temperatures outside can affect the time as well.</p>
<p>Do I need to empty the ashes every time?</p>	<p>Yes, this will start you off with a fresh burn cup. If you do not empty the ashes, burner may not ignite, you can have temperature swings, flame-outs, and/or burn back into the hopper.</p>
<p>Why is there extra ash in the bottom of the grill?</p>	<p>Ash at the bottom of the grill is normal due to the blower fan that keeps the pellets burning. Make sure that the ash pull out is pushed in all the way, and straight. If it is at an angle, then it will allow extra air to get through, blowing the ash out of the burn cup.</p>
<p>Why have the ash clean out, if all the ash doesn't go into the cup?</p>	<p>The ash clean out system is to help start out with a fresh burn cup each time you cook, without vacuuming it out. You want an empty burn cup each time because this helps the pellets burn better and more efficient without temp swings. We have cut the vacuuming down to only after 50 hours of use, like the manual suggests, instead of each cook.</p>
<p>Smoke is escaping around the lid. Can I add a sealant around my lid?</p>	<p>This pellet grill comes with a lid gasket installed. Even with this gasket, the pellet grill is not air tight. The APEX was designed with a down draft system which directs most of the smoke to escape through the back vents. It is normal to see some smoke escape around the lid and other small holes in the body. This is all part of the air flow and circulation that is required for a superior cook.</p>
<p>Is it normal for my grill to put off a lot of smoke at first?</p>	<p>Yes. This is due to the igniting of the pellets.</p>
<p>Is it normal for my grill to produce little to no smoke?</p>	<p>At higher temp settings, there will be less smoke, due to the burning of pellets. On the lower settings, the pellets are smoldering, so there will be more smoke, however the smoke comes in waves throughout cooking.</p>

Why is my grill fluctuating in temperature?	Temperature variation is normal. Your grill will not have the same temperature readout like an oven (even though your oven at home has a similar temperature fluctuation.) It is programmed to let the flame go out and smolder, creating more smoke. If it never did this, there would be very little smoke. This creates temperature swings, but the cooking results are great.
Why won't my grill get below 180-220 ° F when set at 160 ° F ?	Due to the grill being made from steel, you will want to make sure it's in the shade, and not in direct sunlight, especially when it's hot outside. Think of how hot your car can get during the summer months. Kinda the same thing. Therefore it's normal to not be able to get lower temps on hot days.
Why is there smoke coming out of the hopper, through my pellets?	A little smoke is normal when airflow is restricted through the vents or wind is blowing through the vents.
How many pounds of pellets will I go through per hour on a 24-inch pellet grill?	There are many variables that play into this, however in good weather, on high setting, the grill will burn about 3.8 lbs. of pellets per hour.
How many pounds of pellets will I go through, per hour, on a 36-inch pellet grill?	There are many variables that play into this, however in good weather, on high setting, the grill will burn about 3.8 lbs. of pellets per hour.
During winter/colder months, how do I ensure my grill stays up to temperature?	A few tips are to make sure meat is at room temperature, not straight from fridge; make sure that the lid is not open for very long when putting food in; when using lower settings, turn knob to 350, then once temperature gets to desired setting, turn down to the desired setting.
What is the Bypass for?	You are given the option to bypass in both the feed and startup modes. You can bypass in the feed mode if you hear pellets dropping into the burn chamber. Only bypass startup if your grill is still hot. For example, if there is a power outage and the grill accidentally shuts off, or if you need to restart the grill and it is still hot, then you would use Bypass Mode. This mode is to be used only if the grill has been shut off momentarily and the pellets in the burn cup are still hot enough to ignite the pellets.
Are there different heat zones in my pellet grill?	Yes. Due to heat rising and the fan blowing to keep the pellets burning, there are heat zones throughout the pellet grill. You can test the heat zones by baking biscuits in the chamber and comparing the brownness of each area
Can I line my drip pan in foil?	Yes, you can line your drip pan in foil for easy cleanup. We would just recommend double checking the foil and make sure there are no paths for the oil to go into the bottom of the pellet grill.
Can I convert my pellet grill into a slide and grill?	No, we do not have any kits or directions to do so.

FREQUENTLY ASKED QUESTIONS

What kind of wood do you use for your pellets? Do you use any additives in your pellets?	We use 100% all-natural, virgin hardwood that comes from trees in the US to make our pellets. We DO NOT use any type of wood that may contain any chemicals, glue, or anything at all added. Our pellets are not comprised of any recycled wood or wood that may contain construction material by-products or waste such as particle board, sheeting or any construction grade material. Only 100% all-natural, virgin hardwood. We do not add any additional flavoring additives either, so your food is left with the flavor you intended. That delicious, pure, natural wood smoked flavor.
Why is black stuff peeling from inside my grill?	This is a deposit of grease and smoke collecting from normal use. Peeling is easy to remove. Brush off all loose particles with a stainless-steel brush before grilling. To prevent: after every grill session, while the lid is still warm (not hot,) wipe with paper towels or a mild degreaser solution.
Do I need a mobile application to use my grill?	No. The app is not required to use your grill. You can still set temperatures and adjust Smoke Numbers from the controller itself.
Can I add multiple grills to the app?	Yes. After you've set them up within your Camp Chef account you can easily switch between grills within the app.
Can I run one grill with multiple mobile devices?	Yes. Each grill you set up will be connected to your Camp Chef Connect user account. You can run a grill on any device that is logged in to your account.

TROUBLESHOOTING

<p>Why does my grill not turn on after switching the power button to the on position?</p>	<p>Make sure the grill is plugged into a powered outlet. Check the circuit breaker and/or GFCI switch, or test the outlet using another appliance.</p> <p>Unplug the grill and check the fuse located by the power cord inlet, on the back side of the hopper. If the fuse is blown, replace only with a 4.0 Amp 125 V 55x20mm Fast Blow Fuse. Typical fuse markings will be 4A125V, F4A125V, 4A250V, or F4A250V. Make sure to confirm they are a Fast Blow Fuse. Actual fuse dimensions are 5.2x20mm.</p>
<p>My grill does not heat up?</p>	<p>Turn the power off and check the hopper for pellets. Check the firebox to see if there are pellets in it. The easiest way to do this is to pull the burner clean-out lever, remove the cup from the bottom of the grill and check for pellets.</p> <p>If there are a lot of pellets in the cup, reinstall the cup and close the burner clean-out. Remove the grill grates, grease tray, and heat deflector and vacuum out any pellets in the bottom of the grill. Try restarting the the grill and if the pellets are dropping into the the burn cup, but not igniting, the heating rod may need to be replaced. Call customer service.</p> <p>After restarting, if there are no pellets falling into the burn cup, check to see if the auger is turning. If the auger motor is turning, but the auger isn't rotating, the auger pin may be sheared and need to be replaced.</p>
<p>Why is my auger not turning?</p>	<p>You may have wet pellets which have swollen and jammed the auger, if this is the case, call our customer support team. This will require some disassembly to gain access to the auger chamber in order to clean out the jammed pellets.</p>
<p>Why is my grill not feeding pellets, but my auger is turning?</p>	<p>Check to see if there are pellets in the hopper, or if there is something blocking the pellets from going into the auger chamber.</p>
<p>My probe temperatures do not display?</p>	<p>Make sure the meat thermometer is connected properly to the controller. If it still doesn't work, the probe may be damaged and need to be replaced.</p>
<p>My Ash Clean-out is stuck, what do I do?</p>	<p>There is a protectant we use on the raw steel, and when it heats up, it all goes down to the bottom of the grill, causing the two to stick together. Try hitting the plate from the bottom of the grill, with a rubber mallet, in an upward motion or from the inside of the grill, downward. This should free the two pieces.</p>
<p>Why am I blowing the fuse?</p>	<p>It's most likely the Hot Rod, however you will want to check the blower and auger motor also. To check the Hot Rod and motors: disconnect the Hot Rod wires (Purple, A) from the controller, turn the dial to any of the temperature settings. If you don't blow a fuse, then it's most likely the Hot Rod. Repeat with the other wires. Make sure to replace with the correct fuse. 4 AMP 125 or 250 V, Fast Blow Fuse.</p>

TROUBLESHOOTING

Why won't my grill connect to WIFI?	<p>This may be due to a number of factors. Use the following to troubleshoot:</p> <ol style="list-style-type: none">1. Make sure your grill is in range of your WiFi router.2. Ensure you have a 2.4GHz WiFi network in range.3. Check to ensure your phone is connected to the same network when setting your grill up for WIFI.4. Click the 'show password' icon to review your network password to ensure there are no typos.5. If the initial WiFi connection times out, do the following:<ol style="list-style-type: none">a. Do NOT close the app or move to a different screen yetb. Turn off the grill, count to 5 slowly, turn it back on.c. Tap the "SKIP FOR NOW" button in the app - it may be hidden beneath the on-screen keyboard.d. After a few moments the WiFi icon on the grill should turn black.
Why does my app keep force closing or crashing?	<p>This may happen if you have an outdated version of the app. Go to the App store or Google Play Store and check for updates. Please update to the latest version if there is one available. If that doesn't work, try restarting your phone or uninstalling and reinstalling the app.</p>
What does it mean if I have "lost communication?"	<p>Loss of communication could mean a few things. Check that your Bluetooth is out of range, your grill has lost its WIFI signal, or your phone is no longer connected to the internet.</p>

I cannot get my WiFi/Bluetooth reconnected. I've reset everything, uninstalled the the app on my device, it recognizes the grill but never makes the connection.

Do the following:

1. Go into the app's Device Management and remove the grill from your account by swiping it away to the left.
2. In your phone's Bluetooth settings, find an item named "CampChef:xx:xx" and forget or unpair it.
3. On the grill go to Settings and choose Reset. This will forget the Bluetooth and WiFi configurations for the grill.
4. Turn the grill off, count to 5 slowly, and turn it back on. Close the app entirely (not just minimized, actually swipe it closed) and reopen it.
5. Go into the app and then search for the grill; select it from the search results. The app should prompt you for a PIN that is displayed on the grill.
6. The app will now show you a list of available WiFi networks. If yours is not on the list, ensure that it supports 2.4GHz devices (contact your internet service provider or router manufacturer to determine this.) Note that you can also enter a network name manually if it isn't in the list. To do this, press 'Add Network', then a popup will say "ENTER NETWORK SSID." Type in the name of the WiFi network (it is case sensitive) and enter password and then hit the 'Connect' button.
7. Select or enter your desired WiFi network, then enter the password.

TROUBLESHOOTING - ERROR CODES

SENSOR	This is an error code that occurs with the meat probe. Check to see if you have your meat probe inserted into the port on the faceplate. If you have your meat probe inserted, try unplugging the probe and then plugging it back in. If the error code persists, then you may need a new meat probe.
FLAME ERROR	This happens when the fire in the grill goes out or falls below a certain temperature and does not go back up. This happens more so in the winter months. Also, make sure the pellets are dry and do not have any moisture in them. If they crumble easy, then they have moisture in them.
SENSOR	This is an error code that occurs with the RTD. Check that the RTD connection is tight. Try unplugging and plugging it back in. If the error code persists, you may need a new RTD
OVER TEMP	For your safety, if the grill goes over 600F, the controller will automatically shut down the pellet portion of the grill to avoid large grease fires.
WARNING	Your pellet level is getting low, fill up your hopper before your flame goes out.

SERVICE AND WARRANTY

3 YEAR LIMITED WARRANTY (from date of purchase)

Camp Chef No-Hassle Warranty:

Here at Camp Chef we stand by our products and take pride in our customer service. Because of this, your new Camp Chef product comes with a No-Hassle Warranty. We warrant that our products will be free from defects in all materials and workmanship (excluding paint and finish) for the Warranty Coverage Period described below. This warranty is extended only to the original consumer purchaser. During the Warranty Coverage Period, we will (at our sole option) replace any defective part or product covered by this warranty when provided with proof of purchase. The replacement will be without charge.

Required Maintenance:

Clean your product after each use to maintain its finish and prolong its lifespan. Wipe away all grease and ashes. Keep metal products free of moisture, salts, acids and harsh fluctuations in temperature. Product paint and other finishes are not covered by this warranty. The exterior finish of the product will wear down over time.

Coverage Details:

Warranty does not cover normal wear of parts or damage caused by misuse, abuse, overheating and alteration. No alterations are covered in this warranty. Camp Chef is not responsible for any loss due to neglectful operation. Furthermore, this warranty does not cover products damaged or rendered defective due to accident, misuse, abuse, modification, water damage, neglect, improper handling or storage, improper maintenance or installation, incorporation of third-party components or exposure to weather, natural disasters such as earthquakes, hurricanes, tornadoes, floods, lightning, fires, or failure to follow instructions for use.

ANY WARRANTIES IMPLIED BY LAW SHALL IN NO EVENT EXTEND BEYOND DURATION OF THIS EXPRESS WARRANTY. Some States do not allow limitations on how long an implied warranty lasts, so the above limitation may not apply to you. REPAIR OR REPLACEMENT AS PROVIDED HEREIN IS YOUR EXCLUSIVE REMEDY FOR ANY DEFECTIVE PRODUCT. IN NO EVENT SHALL WE BE LIABLE FOR ANY SPECIAL, INCIDENTAL OR CONSEQUENTIAL DAMAGES OF ANY KIND ARISING OUT OF THE PURCHASE OR USE OF THIS PRODUCT, WHETHER BASED UPON CONTRACT, TORT, STATUTE OR OTHERWISE. Some states do not allow the exclusion or limitation of incidental or consequential damages, so the above limitation or exclusion may not apply to you. This warranty gives you specific legal rights, and you may also have other rights which vary from State to State.

Please keep all original sales receipts from the authorized dealer. Proof of purchase is required to obtain warranty services. Any parts or products returned without written authorization will be discarded without notice.

To obtain warranty services submit a warranty request at www.campchef.com/warranty-information or call (800) 650-2433. Our English speaking Product Specialists are happy to help and are available Monday - Friday, between 9 am to 5 pm, MST at (800) 650-2433.

Warranty applies to the United States and Canada.

REPLACEMENT PARTS MODEL PG24HG

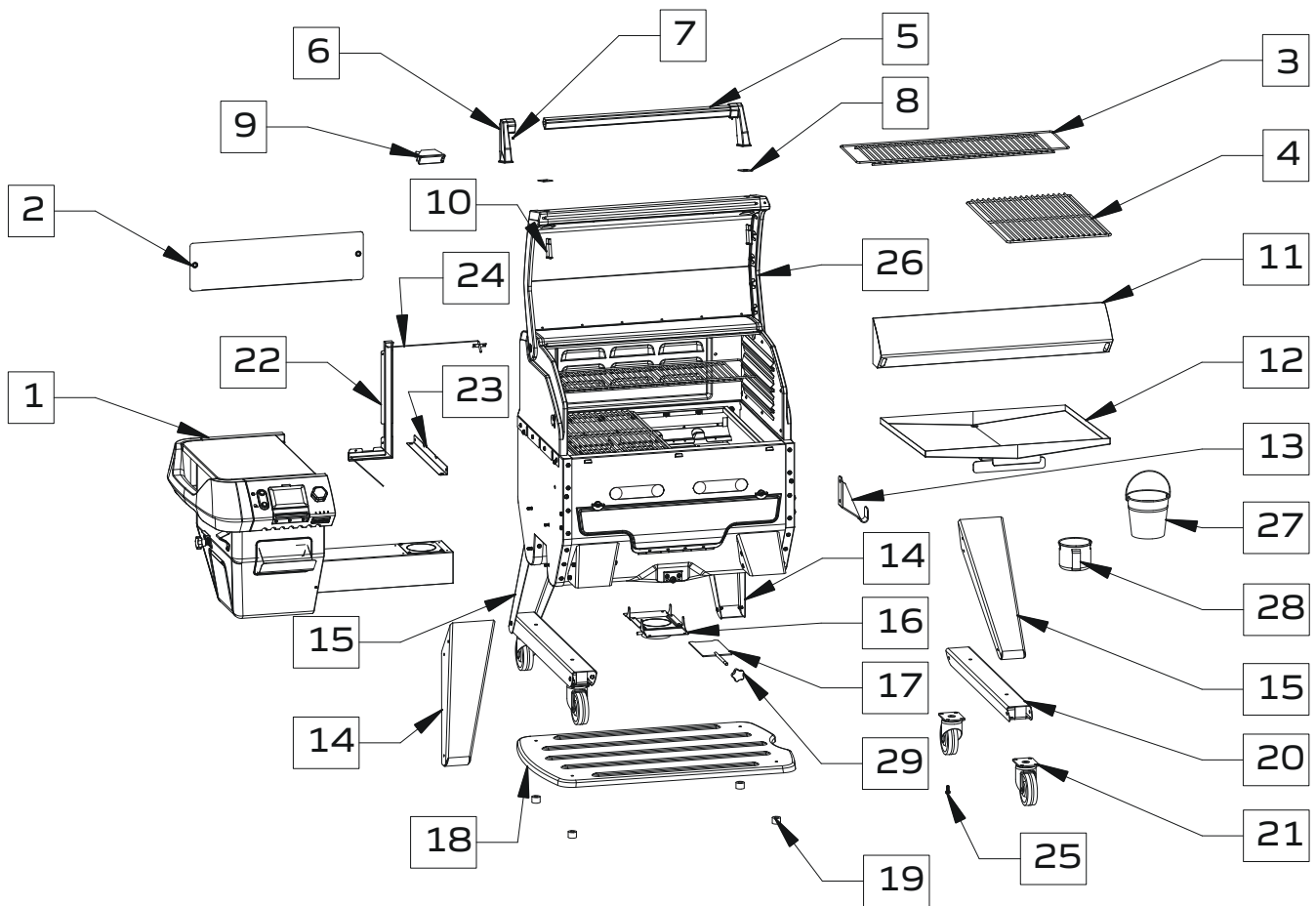

Item	Part Number	Description	Quantity
1	PG24HG-2	Hopper Assembly	1
2	PG24HG-3	Draft Cover	1
3	PG24HG-4	Upper Grate	2
4	PG24HG-5	Lower Grate	2
5	PG24HG-7	Lid Handle	1
6	PG24HG-8	Handle Mount	2
7	PG24HG-9	Set Screw	2
8	PG24HG-10	Handle Insulator	2
9	PG24HG-11	Light	2
10	PG24HG-12	Handle Screw	4
11	PG24HG-13	Valve Cover (no knobs)	1
12	PG24HG-14	Drip Tray	1
13	PG24HG-15	Tank Hook	1
14	PG24HG-16	Leg (FL, BR)	2
15	PG24HG-17	Leg (FR, BL)	2

Item	Part Number	Description	Quantity
16	PG24HG-18	Slide Bracket	1
17	PG24HG-19	Ash Clean-out Plate	1
18	PG24HG-20	Bottom Shelf	1
19	PG24HG-21	Bottom Shelf Bushing	4
20	PG24HG-22	Leg Brace	2
21	PG24HG-23	Caster Wheels	4
22	PG24HG-24	Cable Guide	1
23	PG24HG-25	Hopper Support	1
24	PG24HG-26	RTD (Thermometer)	1
25	PG24HG-27	Hardware Kit	1
26	PG24HG-28	Lid	1
27	PG24-11	Bucket	1
28	PG24-17	Cup	1
29	PG24-9	Pullout Knob	2

REPLACEMENT PARTS MODEL PG36HG

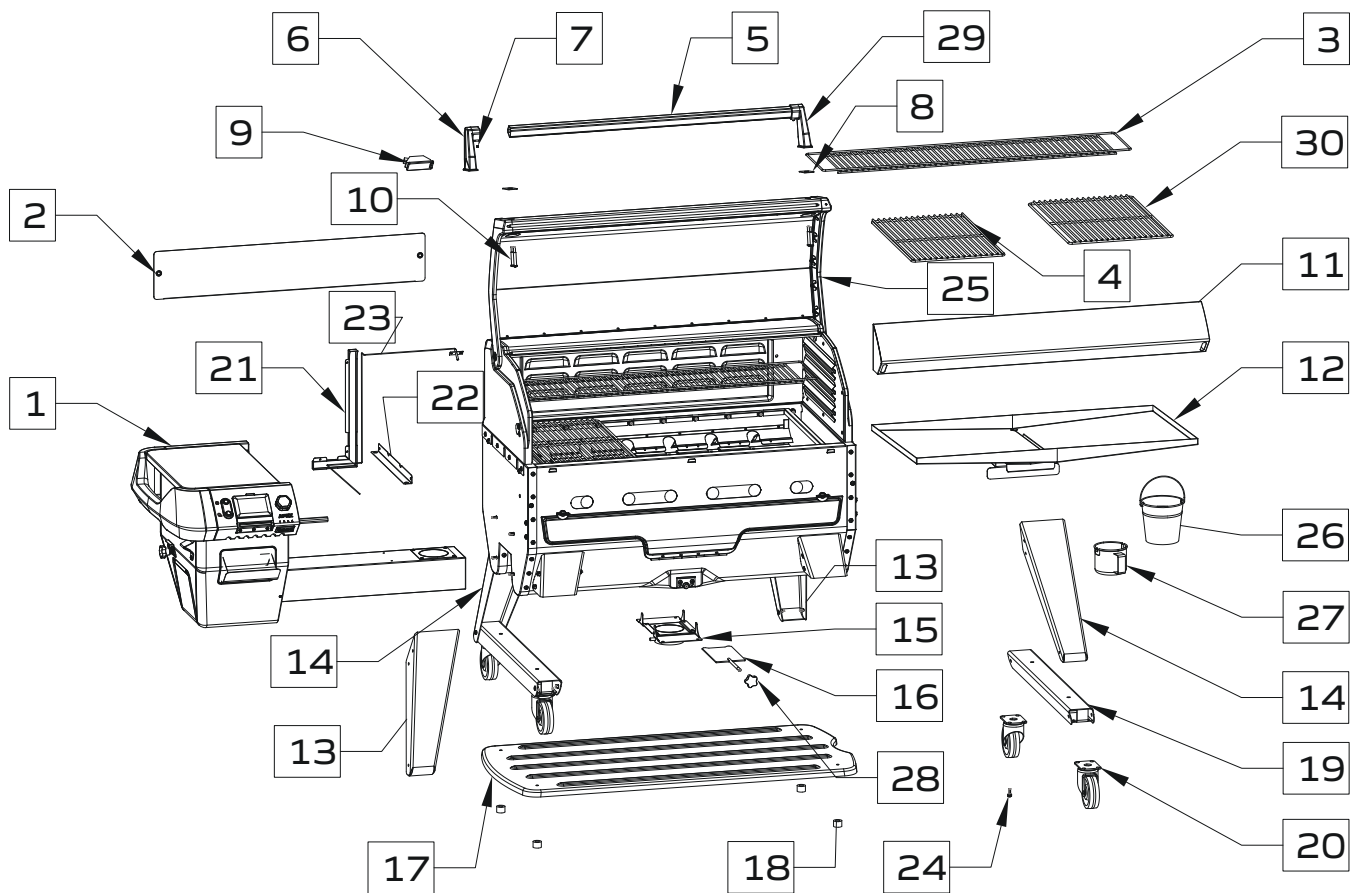

Item	Part Number	Description	Quantity
1	PG36HG-2	Hopper Assembly	1
2	PG36HG-3	Draft Cover	1
3	PG36HG-4	Upper Grate	2
4	PG36HG-5	Lower Grate	2
5	PG36HG-6	Lid Handle	1
6	PG24HG-8	Handle Mount	2
7	PG24HG-9	Set Screw	2
8	PG24HG-10	Handle Insulator	2
9	PG24HG-11	Light	2
10	PG24HG-12	Handle Screw	4
11	PG36HG-7	Valve Cover (no knobs)	1
12	PG36HG-8	Drip Tray	1
13	PG24HG-15	Tank Hook	1
14	PG24HG-16	Leg (FL, BR)	2
15	PG24HG-17	Leg (FR, BL)	2

Item	Part Number	Description	Quantity
16	PG24HG-18	Slide Bracket	1
17	PG24HG-19	Ash Clean-out Plate	1
18	PG36HG-9	Bottom Shelf	1
19	PG24HG-21	Bottom Shelf Bushing	4
20	PG24HG-22	Leg Brace	2
21	PG24HG-23	Caster Wheels	4
22	PG24HG-24	Cable Guide	1
23	PG24HG-25	Hopper Support	1
24	PG24HG-26	RTD (Thermometer)	1
25	PG36HG-10	Hardware Kit	1
26	PG36HG-11	Lid	1
27	PG24-11	Bucket	1
28	PG24-17	Cup	1
29	PG24-9	Pullout Knob	2
30	PG24HG-5	Lower Grate	2

CONTROLLER WIRING DIAGRAM

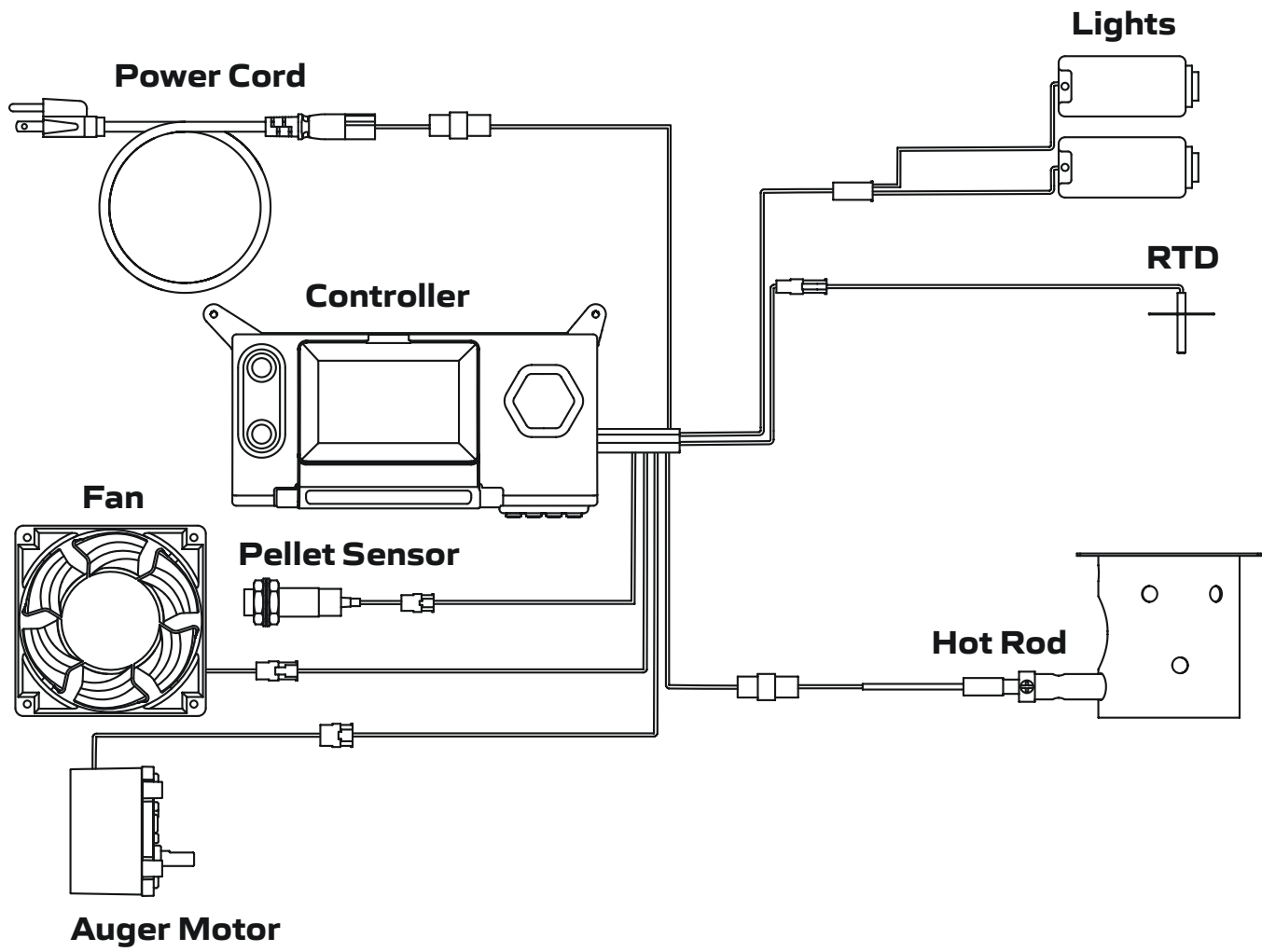



**#FEED
YOUR
OUT
SIDE**



www.CampChef.com | 1.800.650.2433 • Camp Chef is a registered trademark of Logan Outdoor Products
©2021 • Patent Pending • 301 Camp Chef Way, Hyde Park, UT 84318, USA • 1221_PG24HG_Booklet