

# **BLAZE KING**

## **OWNERS MANUAL**

MODELS  
**KING KT1102**  
**PRINCESS PT1003**

*NON-CATALYTIC  
SOLID FUEL WOOD HEATERS*

## **SAVE THESE INSTRUCTIONS**

**VALLEY COMFORT SYSTEMS INC.**  
1290 COMMERCIAL WAY  
PENTICTON, B.C. V2A 3H5  
PHONE (250) 493-7444



Pour la version française de nos manuels S.V.P. vous référez à notre site web : [www.blazeking.com](http://www.blazeking.com)

# TABLE OF CONTENTS

<b>GENERAL INFORMATION</b> .....	2-8
Table of contents .....	2
Safety Notice .....	3
Introduction .....	4
Warranty .....	5-8
Definitions .....	9&10
General Specifications .....	10
<b>SAFETY</b> .....	10-12
Chimney Fire .....	10
Building & Fire Codes, Permits, & Inspections .....	11
Children .....	11
Clearances .....	11
Fuel .....	11
Disposal of Ashes .....	12
Chimneys .....	12
Creosote and Soot .....	12
Door Gasket and Glass .....	12
<b>OPERATION</b> .....	13-15
Starting a Fire .....	13
Combustion and Air Control .....	13
Reloading the Firebox .....	14
Fan Operation .....	15
Ash Removal .....	15
<b>MAINTENANCE</b> .....	15-17
Authorized Service Representative .....	15
Removal of Creosote & Soot .....	15
Loading Door Gasket Maintenance .....	15
Adjusting the Door Catch Tension .....	16
Replacing the Door Gasket .....	16
Gold Door Maintenance .....	16
Cleaning the Glass .....	16
Loading Door Glass Replacement .....	16
Chimney Drafts .....	17
Optional Fan Assembly .....	17
<b>TROUBLE SHOOTING</b> .....	18-20
<b>PREPARATION AND ASSEMBLY</b> .....	20&21
Planning for Your Stove Placement .....	20
Check Your Chimney .....	20
Combustion Air Required .....	21
<b>INSTALLATION</b> .....	21-25
General Instructions .....	21
Floor Protector .....	22
Chimney Connector .....	22
Clearances to Combustible Materials .....	22&23
Installation Using a Metal Chimney .....	24
Installation Using a Masonry Chimney .....	25
<b>PRINCESS PT1003 BRICK LAYOUT</b> .....	26
<b>KING KT1003 BRICK LAYOUT</b> .....	27

# **SAFETY NOTICE**

**IF THE BLAZE KING STOVE IS NOT PROPERLY INSTALLED AND OPERATED, A HOUSE FIRE MAY RESULT. FOR YOUR SAFETY, FOLLOW THE INSTALLATION DIRECTIONS. CONTACT LOCAL BUILDING OR FIRE OFFICIALS ABOUT RESTRICTIONS AND INSTALLATION INSPECTION REQUIREMENTS IN YOUR AREA.**

**THIS STOVE MUST BE CONNECTED TO A LISTED HIGH TEMPERATURE PREFABRICATED METAL CHIMNEY LABELLED FOR USE WITH SOLID FUELS OR AN APPROVED MASONRY CHIMNEY WITH A FLUE LINER.**

## **SAVE THESE INSTRUCTIONS**

Dear Customer:

Thank you for purchasing a Blaze King wood burning stove. The Blaze King stoves contemporary elegance makes it the first choice for enhancing the decor of your home.

This owner's manual explains the steps required to safely assemble, install, operate, and maintain your new stove. Please be a responsible stove owner; carefully read these requirements for safe installation and proper operation BEFORE installing and using your stove. We want your Blaze King to give you a lifetime of trouble-free operation.

While we have made every effort to make these instructions as complete as possible, some installation or operating conditions may not be covered. If you have any questions that are not answered here, contact your BLAZE KING dealer, Local Building Inspector, Fire Department, or our customer service department at Blaze King/Valley Comfort Systems Inc. 250-493-7444. We do not accept collect phone calls at the factory.

The Management and Employees of  
VALLEY COMFORT SYSTEMS INC.

**KEEP THIS MANUAL FOR FUTURE REFERENCE.**

# WARRANTY

## BLAZE KING WOOD LIMITED WARRANTY

Blaze King and its respective brands extend the following warranty for wood fired appliances purchased from an authorized Blaze King dealer and installed in the United States of America or Canada. Warranty starts with date of purchase by the original owner (End User) except as noted for replacement parts.

Warranty Period		Components Covered	
Parts	Labor	Wood	
1 Year		X	All parts, materials and surface finishes (flaking and peeling) Subject to Conditions, Exclusion, and Limitations listed
2 Years		X	Fan assemblies and motors, thermal sensors, catalytic thermometer , bi-metallic thermostat assembly
5 Years	2 Year	X	Firebox & Heat Exchanger, Bypass Door Steel Components
6 Years		X	Catalyst Combustor ( see Conditions, Exclusions, and Limitations)
1 Year		X	Other Replacement Parts
See Conditions, Exclusions, and Limitations.			

## Blaze King Wood Limited 5 Year Warranty

Blaze King is the manufacturer of the Blaze King line of heating products. At Blaze King, our commitment to the highest level of quality and customer service is the most important thing we do. Each Blaze King stove is built on a tradition of using only the finest materials and is backed by our limited warranty to the original purchaser. With Blaze King, you're not just buying a stove; you're buying a company with years of unequalled performance and quality.

### Limited Six (6) Year Warranty:

The CATALYTIC COMBUSTOR is under warranty by Blaze King for six (6) years from the date of original retail purchase. The purchaser shall pay the following share of the then current retail price for the combustor: The first three (3) years no charge, 4th year 60%; 5th year 70%, 6<sup>th</sup> year 80%. The Combustor must be returned to your dealer along with a completed COMBUSTOR FAILURE REPORT and original proof of purchase document.

### Limited (5) Year Warranty:

Under this warranty, Blaze King covers the stove body and accessories against defects in materials and workmanship, for part repair or replacement for the first five (5) years \*\*\* to the original purchaser. This Warranty covers: All Steel firebox components against defects in material and workmanship. Please see the exclusions and limitation section below as certain restrictions and exclusions apply to this warranty.

### Limited Two (2) Year Warranty:

Under this warranty, Blaze King covers, fan assemblies and modular thermostat against defects in materials and workmanship, for part repair or replacement and limited labor for the first two (2) years to the original purchaser. Please see the exclusions and limitation section below as certain restrictions and exclusions apply to this warranty.

### Limited One (1) Year Warranty:

Under this warranty, Blaze King covers all parts and materials against defects in materials and workmanship including exterior paint finishes, for part repair or replacement and limited labor for the first year to the original purchaser. Please see the exclusions and limitation section below as certain restrictions and exclusions apply to this warranty.

### How the Warranty Works

1. All warranties by the manufacturer are set herein and no claim shall be made against the manufacturer on any oral warranty or representation. All claims under this Limited Warranty must be made in writing by your dealer.
2. Any stove or part thereof that is repaired or replaced during the Limited Warranty period will be warranted under the terms of the Limited Warranty for a period not exceeding the remaining term of the original Limited Warranty or six (6) months, whichever is longer.
3. For any part or parts of this stove, which in our judgment show evidence of defects, Blaze King reserves the option to repair or to replace the defective part(s) through an accredited distributor or agent, provided the defective part is returned to the distributor or agent, transportation prepaid, if requested.
4. If you discover a problem that you think may be covered by the Limited Warranty, you MUST REPORT it to your Blaze King dealer WITHIN 30 DAYS from the date the problem was first detected, giving them proof of purchase and the date of purchase. The dealer will investigate the problem and work with Blaze King to determine whether the problem:
  - a) Is covered by the Limited Warranty or
  - b) Can be fixed in your home or does the product need to be returned to Blaze King for repair.
5. If Blaze King determines that the stove needs to be returned to Blaze King for repair, the customer has the responsibility and the expense of removing it from their home and shipping it to Blaze King. If the problem is covered by the Warranty, Blaze King will repair or replace the item at their discretion and the customer will be responsible for return shipping and re-installation in their home.
6. If the problem is not covered by the Limited Warranty, the customer will be responsible for all repair costs, as well as all storage, shipping and the cost of removing and re-installing the stove.

If you are not satisfied with the service provided by the Blaze King dealer, write to Blaze King at the address listed on the last page of the Owner's Manual. Include a copy of the original purchase invoice and a description of the problem.

### **Exclusions and Limitations:**

1. This Warranty does not cover tarnish, discoloration or wear on the plated surfaces. Painted finishes will change colour after initial firing and will continue to change through the lifetime of the stove. This is normal occurrence for all high temperature coatings.
2. This Warranty does not cover gasket material or firebrick.
3. Blaze King strongly recommends installation by a certified installer. Failure to comply may adversely affect coverage under the terms of this warranty. This Limited Warranty covers defects in materials and workmanship only if the product has been installed in accordance with local building and fire codes; in their absence refer to the owner's manual. If the product is damaged or broken as a result of any alteration, wilful abuse, mishandling, accident, neglect, or misuse of the product, the Limited Warranty does not apply.
4. The stove must be operated and maintained at all times in accordance with the instructions in the Owner's Manual. If the unit shows signs of neglect or misuse, it is not covered under the terms of this Warranty policy. Performance problems due to operator error will not be covered by the Limited Warranty policy.
5. Some minor expansion, contraction, or movement of certain parts and resulting noise, is normal and not a defect and, therefore, is not covered under this Limited Warranty.
6. Misuse includes over-firing. Over-firing can be identified later by warped plates and paint pigment being burnt off. Over-firing this appliance can cause serious damage and will nullify the Limited Warranty.
7. The Limited Warranty will cover glass thermal breakage only and will not cover misuse of the stove glass, including but not limited to:
  - a) Glass that is struck, has surface contaminates or has had harsh or abrasive cleaners used on it.
  - b) If the door is slammed or is closed while wood in the firebox is protruding out the stove opening thus striking the glass.
8. This warranty does not cover products made or provided by other manufacturers and used in conjunction with the operation of this stove without prior authorization from Blaze King. The use of such products may nullify the Limited Warranty on this stove. If unsure as to the extent of this Limited Warranty, contact your authorized Blaze King dealer before installation.
9. Blaze King will not be responsible for inadequate performance caused by environmental conditions.
10. The Limited Warranty does not cover installation and operational related problems such as use of downdrafts or spillage caused by environmental conditions. Environmental conditions include but are not limited to nearby trees, buildings, roof tops, wind, hills, mountains, inadequate venting or ventilation, excessive offsets, negative air pressures or other influences caused by mechanical systems such as furnaces, fans, clothes dryers etc.
11. The Limited Warranty does not cover damage caused by burning salt-saturated wood, corrosive driftwood, chemically treated wood or any fuel not recommended in the Owner's Manual (use cord wood only).

The Limited Warranty is void if:

  - a) The stove has been operated in atmospheres contaminated by chlorine, fluorine or other damaging chemicals.
  - b) The stove is subject to submersion in water or prolonged periods of dampness or condensation.
  - c) Any damage to the unit, combustion chamber or other components due to water, or weather damage which is the result of, but not limited to, improper chimney/venting installation.
  - d) Salt air in coastal areas or high humidity can be corrosive to the finish; these environmental conditions can cause rusting. Damage caused by salt air or high humidity is not covered by the Limited Warranty.
12. Exclusions to the Limited Warranty include: injury, loss of use, damage, failure to function due to accident, negligence, misuse, improper installation, alteration or adjustment of the manufacturer's settings of components, lack of proper and regular maintenance, alteration, or act of God.
13. The Limited Warranty does not cover damage caused to the stove while in transit. If this occurs, do not operate the stove and contact your courier and/or dealer.
14. The Limited Warranty does not extend to or include paint, door or glass gaskets or firebricks damage caused by normal wear and tear, such as paint discoloration or chipping, worn or torn gaskets, chipped or cracked firebrick, etc.
15. The Limited Warranty does not include damage to the unit caused by abuse, improper installation, or modification of the unit.
16. Damage to plated surfaces caused by fingerprints, scratches, melted items, or other external scores and residues left on the plated surfaces from the use of abrasive cleaners or polishes is not covered in this warranty.
17. Blaze King is free of liability for any damages caused by the stove, as well as inconvenience expenses and materials. The Limited Warranty does not cover incidental or consequential damages.
18. The Limited Warranty does not cover any loss or damage incurred by the use or removal of any component or apparatus to or from the Blaze King stove without the express written permission of Blaze King and bearing a Blaze King label of approval.
19. Any statement or representation of Blaze King Products and their performance contained in Blaze King advertising, packaging literature, or printed material is not part of the Limited Warranty.
20. The Limited Warranty is automatically voided if the stove's serial number has been removed or altered in any way. If the stove is used for commercial purposes, it is excluded from the Limited Warranty.
21. No dealer, distributor, or similar person has the authority to represent or warrant Blaze King Products beyond the terms contained within the Limited Warranty. Blaze King assumes no liability for such warranties or representations.
22. Blaze King will not cover the cost of the removal or re-installation of the stove, hearth, facing, mantels, venting or other components.

23. Labor to replace or repair items under this Limited Warranty will be covered per our warranty service fee reimbursement and labor rates are set per component schedule. Labor rates vary from location to location and as such total labor costs may not be covered. Please consult with your dealer or service technician for any additional charges such as travel time or additional labor charges that may apply.
24. For parts of the Blaze King woodstove or fireplace insert warranted beyond the first year, the five year limited warranty will have the same obligations as described in this document, provided, however that the purchaser shall pay the following percentage of the then current retail cost of the repair or the replacement, according to the year after purchase in the which the defect is brought to the attention of Blaze King. \* \* \* During the 2<sup>nd</sup> year----purchaser pays 20%.  
3<sup>rd</sup> year ----purchaser pays 40%. 4<sup>th</sup> year -----purchaser pays 60%. 5<sup>th</sup> year---- purchaser pays 80%.
25. If a defect or problem is determined by Blaze King to be non warrantable, Blaze King is not liable for travel costs for service work. In the event of in-home repair work, the customer will pay any in-home travel fees or service charges required by the Authorized Dealer.
26. At no time will Blaze King be liable for any consequential damages which exceed the purchase price of the unit. Blaze King has no obligation to enhance or modify any stove once manufactured (example: as a stove model evolves, field modifications or upgrades will not be performed).
27. This Limited Warranty is applicable only to the original purchaser and it is non-transferable.
28. This warranty only covers Blaze King Products that are purchased through an authorized Blaze King dealer.
29. If for any reason any section of the Limited Warranty is declared invalid, the balance of the warranty remains in effect and all other clauses shall remain in effect.
30. The Limited Warranty is the only warranty supplied by Blaze King, the manufacturer of the stove. All other warranties, whether express or implied, are hereby expressly disclaimed and the purchaser's recourse is expressly limited to the Limited Warranty.
31. Blaze King and its employees or representatives will not assume any liability for damages, either directly or indirectly, caused by improper usage, operation, installation, servicing or maintenance of this stove.
32. Blaze King reserves the right to make changes without notice. Please complete and mail the warranty registration card and have the installer fill in the installation data sheet in the back of the manual for warranty and future reference.
33. Blaze King is responsible for stocking parts for a maximum of seven (7) years after discontinuing the manufacture or incorporation of the item into its products. An exception to this would be if an OEM supplier is not able to supply a part.

## **DEFINITIONS**

### **CHIMNEY**

One or more passageways, vertical or nearly so, for sending flue gases (smoke) to the outside atmosphere. You must ensure proper clearances are maintained from combustible materials.

### **CHIMNEY CONNECTOR**

Also known as stove pipe. Connects a fuel-burning appliance to a chimney. A chimney connector shall not pass through an attic or roof space, closet or similar concealed space, or a floor, ceiling, wall or partition of combustible construction. The chimney connector should be minimum 24 MSG black/blue steel.

### **COMBUSTIBLE MATERIAL**

Material made of or surfaced with wood, compressed paper, plant fibers, plastics, or other materials that will ignite and burn, whether flame proofed or not, or whether plastered or not plastered.

### **COMBUSTION AIR INTAKE**

Located on the back of the stove, on the center line. Combustion air is drawn into this opening, through the control and into the firebox.

### **FANS (Optional)**

Two variable speed axial fans (105 CFM each). The fans circulate room air around the firebox and back into the home.

### **FAN SPEED CONTROL**

Located on the fan assembly, controls the fan speed.

### **FIREBOX**

Steel, lined with firebrick. The recommended length log that should be used is as follows: PRINCESS 16", KING 17"

### **FLOOR PROTECTOR**

Noncombustible surfacing applied to the floor area underneath and extending in front, to the sides and to the rear of a heat producing appliance

### **FLUE**

The general term for a passage through which flue gasses pass from the combustion chamber to the outside air.

### **HEARTH**

The floor area within the fire chamber of the stove. The bottom of the firebox. Build the fire directly on the hearth.

### **MOBILE HOME**

A residence mounted on wheels, or capable of having wheels installed for moving to another location. Frequently referred to as "Manufactured Homes" to differentiate between travel trailers and more permanent residences. **KT & PT MODELS ARE NOT APPROVED FOR MOBILE HOME APPLICATIONS.**

## THIMBLE

A manufactured or site-constructed (brick) device installed in combustible walls. It is intended to keep walls from overheating. Note; Unprotected single wall flue connector pipe requires 18 inches clearance to combustibles unless otherwise specified on the appliance label.

## GENERAL SPECIFICATIONS

	<b>PRINCESS 1003</b>	<b>KING 1102</b>
Heat output, btu, using average density fir firewood	47000	59000
Recommended wood length	16"	17"
cross loading	19"	22"
Total weight	350lbs	410lbs
Width	27"	30"
Height	29"	33"
Depth	29"	31"
Flue size	7"	8"
Door opening approx	10"x16"	11"x18"

### Options all models

Fan- twin fans variable speed to 210 cfm.  
Side shield kits for closer side clearance  
Rear shield kits for closer rear clearance  
Glass doors standard, solid door option  
Gold plated glass door

## SAFETY

### CHIMNEY FIRE

In the event of a fire in the chimney;

- 1) Adjust the thermostat to its lowest setting.
- 2) Check the loading door to be sure it is tightly closed.
- 3) Get everyone out of the house.
- 4) Call the Fire Department immediately.

After the fire is out, have your chimney inspected by a Building Inspector or certified chimney sweep. Any damaged chimney components should be replaced before the stove is used again.

A masonry chimney that is damaged should be repaired or rebuilt. Contact your Fire Department for further advice. Your family should have a prearranged plan so that each person will know what to do and will act immediately if such an emergency arises.

## **BUILDING AND FIRE CODES, PERMITS, AND INSPECTIONS.**

The installation of this woodstove must comply with your local building and fire codes. Always contact your local Building Inspector and/or Fire Department before beginning the installation process. If required, obtain a permit before installation and have the completed installation inspected.

## **CHILDREN**

Do not allow children to play near the stove or with the operating knobs. Severe burns may be inflicted by touching some of the parts of the stove and by opening the loading door. Train children to stay away from the stove and never leave children unattended in the room when the stove is in operation.

## **CLEARANCES TO COMBUSTIBLE MATERIALS**

For a safe installation, proper clearances to combustible materials must be observed (FIGURE 3 ). Failure to follow these guidelines voids the certification and warranty, is illegal, and can result in a fire causing property damage, injury, or death.

Keep combustible (burnable) materials at least as far away from the woodstove as indicated in Figure 3.

Combustible materials include items such as plasterboard or wood-paneled walls, furniture, wooden mantels, bookshelves, carpets and drapes. Firewood should not be stored within the specified clearances.

Maintain the designated clearance distance to combustibles. Insulation must not touch the chimney. There must be the designated air space clearance around the chimney. This air space around a chimney is necessary to allow natural heat removal from the area. Insulation in this space will cause a heat buildup which may ignite wood framing.

## **FUEL**

USE SOLID FUEL ONLY IN THIS WOODSTOVE. DO NOT BURN COAL. NEVER USE GASOLINE, GASOLINE-TYPE LANTERN FUEL, KEROSENE, CHARCOAL LIGHTER FLUID OR SIMILAR LIQUIDS TO START OR 'FRESHEN UP' A FIRE IN THIS HEATER. KEEP ALL SUCH LIQUIDS WELL AWAY FROM THE HEATER WHILE IT IS IN USE.

Do not burn materials soaked in flammable liquids, trash, garbage, plastics, gift wrappings, coal, charcoal, naphtha, engine oil, chemical cleaners, chemical fire starters, treated or painted wood, saltwater drift wood, railroad ties, plywood, particle board. Do not burn sawdust, wood shavings or chips in this woodstove.

When selecting wood for your Blaze King stove it is preferable that you use seasoned wood. Dry, seasoned wood will burn cleaner and produce less creosote. Dry or small pieces of fuel will provide a hotter fire. Larger pieces can be used to provide a longer burn time.

**CAUTION;** Do not place wood fuel within the space heater installation clearances or within the space required for wood loading and ash removal.

## **DISPOSAL OF ASHES**

Ashes should be placed in a metal container with a tight fitting lid. The closed container of ashes should be placed on a noncombustible floor or on the ground, well away from all combustible materials, pending final disposal. If the ashes are disposed of by burial in soil or otherwise locally dispersed, they should be retained in the closed container until all cinders have thoroughly cooled.

### **WARNING**

**REMOVE ASHES ONLY WHEN THEY ARE COLD. NEVER STORE HOT ASHES IN A GARAGE OR BASEMENT. HOT ASHES WILL GENERATE CARBON MONOXIDE AND/OR FLAMMABLE GASES. THESE GASES MAY CAUSE SUFFOCATION.**

## **CHIMNEYS**

The use of make-shift chimney installation is not allowed.

Before connecting any wood-burning unit to an existing chimney, inspect the chimney to be sure it is in good condition. There should be no cracks or holes. Often it is impossible to see these from the outside. A certified chimney sweep should inspect your chimney and give you an accurate assessment of its condition. The cross-section area must not be less than that of the flue collar. Relining or rebuilding may be necessary to make a masonry chimney safe. A proper chimney is most important for safe, satisfactory operation of any wood heating system.

Inspect the chimney and chimney connector at least twice each month during the heating season. Any leak must be repaired. A chimney fire or deterioration can enlarge the hole. This will admit more air and cause exhaust gasses to condense and form creosote. Patches of creosote in your chimney indicate that such leaks are present.

## **CREOSOTE and SOOT**

When wood is burned slowly, it produces tar and other organic vapors which combine with expelled moisture to form creosote. As a result, creosote residue accumulates on the flue lining. When ignited, this creosote makes an extremely hot fire.

The chimney and chimney connector should be inspected at least twice each month during the heating season to determine if a creosote or soot build-up has occurred. If creosote has accumulated it should be removed to reduce the risk of a chimney fire.

Building a small intense fire in your stove is preferable to having a large smoldering one as creosote vapors condense in the relatively cool chimney flue of a slow-burning fire.

Never intentionally start a chimney fire to clean the flue.

## **DOOR GASKET & GLASS**

Check the loading door gasket for deterioration at least twice each heating season. Inspect the gasket for physical deterioration missing sections or obvious leakage. To check the gasket further, insert a piece of paper into the door opening and close and latch the door. Obvious resistance should be felt when pulling the paper out. Repeat this check several times around the perimeter of the door. Do not operate this stove if the door glass is cracked or broken. To replace glass, see page 16.

## **OPERATION**

Your stove's performance (including its efficiency, pollutant emission level and service lifetime) depends largely on how it is operated. You, then, are the most important factor affecting performance. Please read these operation instructions carefully.

### **WARNING - PROVIDE ADEQUATE AIR CIRCULATION**

It is essential that a source of fresh air for combustion be provided at all times when this woodstove is in operation. In extremely tight houses, partially open a window near the woodstove or install an Outside Air Kit.

## **STARTING A FIRE**

1. Use only dry, well seasoned fuel, which has been cut, split and stacked for a minimum of six months.
2. Set the combustion air thermostat fully clockwise to its maximum setting.
3. Place several balls of newspaper near the front of the firebox and put a fairly large quantity of dry kindling on top of the paper. Next, lay two or three pieces of wood on top of the kindling. Light the paper, partially close the loading door so that the latch touches the stove, but do not latch it. Allow the kindling and most of the larger logs to get started, then latch the loading door. If you close the loading door too soon, a new fire may go out. **NEVER LEAVE ANY WOODSTOVE UNATTENDED WHEN THE DOORS ARE NOT TIGHTLY CLOSED.**
4. When the larger wood pieces are well started, open the loading door and load the firebox to the desired level. Close and latch the loading door. Do not abuse the glass door by slamming it or striking it. Never build the fire right up against the glass. Do not force the door closed if there is wood in the firebox that is obstructing it.

Let the fire burn on Medium to High for 20-30 minutes, or until the fire is well established. Then you may adjust the thermostat to achieve the desired room temperature, also see "COMBUSTION AIR CONTROL".

## **COMBUSTION AIR CONTROL - OPTIMUM SETTING LOADING OR RELOADING**

1. Temperature adjustments. Adjustments to achieve the desired room temperature should be made in small increments for the most effective clean-burning operation. After a few days you will know where to set your thermostat to deliver just the heat you require. Small hot fires produce less creosote than large smoldering fires.

After loading & reloading leave the air control in the fully open position (the warmest setting) for 15 minutes, (or until the fire is well established) before making further adjustments. Turning down the thermostat too soon may cause creosote formation in the chimney. Once the fire is well established, adjustments may be made for a low, medium or high fire, depending on heat needs of the home.

For a low fire, (9,000 to 15,000 btu/hour) getting the fire well established is particularly critical. If the wood being used is not well seasoned, it may be necessary to leave the air control setting in the fully open position for much longer than 15 minutes to assure a clean, low burn. When the fire is burning well on high, reset the air control in steps to medium, then lower, over a 5-10 minute period. Watch the flames in the top of firebox. Try to keep a good flame pattern just under the secondary air diffuser

at all times. When there is no flame pattern in the top of the firebox, the stove is less efficient (produces less heat from a load of wood) and burns less clean (makes and deposits more creosote in the chimney system). When starting a low fire, do not turn the fans on for the first 30 minutes.

For a medium burn (16,000 to 22,000 btu/hour) leave the air control set at high for 15 minutes, or until the fire is well established. Then move the air control to the medium setting. Watch for a flame pattern in the top of the stove. When that flame is out the stove is less efficient and burns dirtier. When starting a medium fire, turn the fans on low to medium, depending on the heat needs of the home.

For a high fire (23,000 to 45,000 btu/hour) the air control setting may be left on high at all times. The fans may be turned on medium to high at any time during the burn cycle.

2 Tampering. The internal mechanism of the combustion air thermostat system is adjusted at the factory and **MUST NEVER** be tampered with.

## **RELOADING THE FIREBOX**

1) Maintaining an efficient fire.

A bed of hot coals is the most important requirement for keeping an efficient fire. A bed of hot coals will help the stove maintain a more even temperature as well as getting the new load of wood started easily. Let each full load burn down to a coal bed before reloading. The combustion air control set at the lowest air control setting, permits a low fire even with the firebox full but maintaining a clean burning low fire is easier with a partial load of wood. For medium and high burn rates, a full load of wood may be used. Four 6" diameter logs may burn up to 8 hours. This will vary considerably for many reasons, including type of wood, how well the wood is "seasoned", the air control setting, the position of the stove in the house, and how well the house is insulated.

2) Set the combustion air control knob to the warmest setting for a few seconds before opening the loading door.

## **WARNING**

ALWAYS OPEN THE DOOR LATCH AND ALLOW THE FIRE TO BUILD UP SLIGHTLY BEFORE FULLY OPENING THE LOADING DOOR. IF THE LOADING DOOR IS OPENED TOO FAST, THE SUDDEN INTRODUCTION OF AIR CAN CAUSE THE FIRE TO FLARE AND DISCHARGE SMOKE AND FLAME INTO THE ROOM. SUCH A DISCHARGE CAN BURN PERSONS WHO ARE NEAR THE WOODSTOVE.

3) Rake the bed of hot coals to the front of the firebox before putting the new fuel load in the stove. Allow combustion air to flow under and around the fuel. Load the firebox to the desired level.

4) Close the Loading Door and latch it. Do not abuse the glass door by slamming it or striking it. Do not force the door closed if there is wood in the firebox that is obstructing it.

5) Set the Combustion Air Control as instructed on page 13 titled "COMBUSTION AIR CONTROL".

## **FAN OPERATION (Optional)**

If you have the optional Fan Assembly installed, wait 30 minutes before you turn on the fans to begin circulating the warm air into the room. Use a LOW speed setting when the stove is set for a low burn and a higher speed setting with hotter fires.

## **ASH REMOVAL**

The ashes should be removed any time they come within three inches of the doors lower sill. A thick bed of ashes will significantly limit the amount of wood you can get in the firebox. Wood burns best in a bed of ashes one half inch to one inch thick. It is not necessary or advisable to completely remove all of the ashes when cleaning this woodstove.

## **MAINTENANCE**

### **AUTHORIZED SERVICE REPRESENTATIVE**

Your local BLAZE KING dealer is your authorized service representative. Should you have any problems with operating or maintaining your BLAZE KING STOVE, contact your dealer as soon as possible. The dealer will help you solve operating problems, provide replacement parts, and/or arrange warranty service repairs if required. Dealers will need information such as model, serial number, date of purchase, and a summary of the problem.

### **REMOVAL OF CREOSOTE AND SOOT**

- 1) The chimney connector and chimney should be inspected at least twice each month during the heating season to determine if a creosote or soot buildup has occurred.
- 2) If creosote has accumulated it should be removed to reduce the risk of a chimney fire. Hire a chimney sweep, or clean the chimney yourself with a tight-fitting chimney brush. Makeshift equipment - hoses, tire chains, etc. - can damage the flue and/or do an unsatisfactory cleaning job. The stove should also be inspected at this time and cleaned if needed.
- 3) To inspect and clean the chamber inside the stove, allow the fire to go out and the stove to cool down. Remove the first section of pipe above the stove. Inspect and clean the area immediately below the flue exit. Heavy accumulations of creosote and ash in the secondary chamber, if not removed, may ignite and cause a very intense fire which could structurally damage the stove.
- 4) Re-install the first section of pipe to the stove. Refer to the Installation Instructions.

### **LOADING DOOR GASKET MAINTENANCE**

Safe and efficient operation of any airtight woodstove depends greatly on the integrity of the gaskets. Check the loading door gasket at the beginning of the heating season and at least twice during the heating season. When the gasket is frayed or no longer seals, it must be replaced (see your dealer) Inspect the gasket for physical deterioration, missing sections or obvious leakage. To check the gasket further, insert a piece of paper into the door opening and close and latch the door. Obvious resistance should be felt when pulling the paper out. Repeat this check several times around the perimeter of the door.

## ADJUSTING THE DOOR CATCH TENSION

The door catch on the front of the stove is adjustable. If you need to adjust the door to ensure a gasket air seal around the door, loosen the lock nut. Rotate the catch clockwise to tighten the gasket. Make this adjustment one turn at a time and be careful not to over tighten, that could place excess strain on the door and glass.

## REPLACING THE DOOR GASKET

- 1) If the door gasket is to be replaced, be sure you have a replacement part ready to re-install. See your Blaze King dealer.
- 2) Be sure the fire is out and the stove has cooled down. The door does not have to be removed from the stove. With a pair of pliers, pull the old door gasket out of the channel and dispose of it.
- 3) Clean out the channel so the new gasket can fit smoothly.
- 4) Run a small bead of a door gasket adhesive (see your Blaze King dealer) or high temperature silicone adhesive along the center of the channel. Start the new gasket in the lower right corner. Do not stretch or cut the gasket. Distribute the gasket evenly around the frame.
- 5) Adjust the door catch on the stove front to ensure a proper seal, do not over tighten the door catch as it could place too much pressure on the door frame and glass. See "Adjusting the door catch tension" above.
- 6) Close the Loading Door and allow the adhesive to dry.
- 7) Check the fit of the door gasket. Insert a piece of paper into the door opening and close and latch the door. Obvious resistance should be felt when pulling the paper out. Repeat this check several times around the perimeter of the door. See "Adjusting the door catch tension" above.

## GOLD DOOR MAINTENANCE

The gold plating on the door is 24k gold and hence very soft. Do not use any abrasive cleaners on the gold, just a damp cloth. Use of abrasive cleaners will void the warranty.

## CLEANING THE GLASS

While the glass may coat during a low (overnight) burn, adjusting the thermostat to the warmest setting after reloading each morning will usually allow the glass to clean. Heavier deposits may require hand cleaning. Manual glass cleaning should be done when the stove and glass are cold. **DO NOT CLEAN THE GLASS WHILE IT IS HOT.** Use a soft cloth and wood stove glass cleaner, available from most Blaze King dealers. Other NONABRASIVE household cleaners may also work. After using any cleaner, thoroughly rinse the glass with water to remove any deposits left by the cleaner. Failure to remove all traces of glass cleaner will result in the glass cleaner residue baking on. This residue will be very difficult to remove.

## LOADING DOOR GLASS REPLACEMENT

Your BLAZE KING is equipped with a door which uses a strong, heat resistant ceramic glass intended to withstand extremely high temperatures and tested for continuous use above 1200 degrees Fahrenheit. However, this glass can be broken through improper use. If glass replacement becomes necessary, use only BLAZE KING replacements. **DO NOT SUBSTITUTE ANY OTHER MATERIAL FOR THIS PURPOSE.**

## **WARNING**

**BROKEN DOOR GLASS IS SHARP. ALWAYS WEAR EYE PROTECTION AND PROTECTIVE GLOVES WHEN HANDLING GLASS. DISCARD THE GLASS IN A CLOSED CONTAINER INACCESSIBLE TO CHILDREN.**

- 1) Allow the fire to completely burn out and the stove to cool down.
- 2) Retain all parts for re-installation.
- 3) Open the door and remove the twelve (12) # 10 x 3/8" screws holding the six retainers to the inside of the door.
- 4) Remove the damaged glass and the old glass gasket.
- 5) Install the replacement glass gasket around the outer perimeter. Place the glass in the door frame. Be sure the words "Blaze King" etched in the glass reads correctly when the door is closed.
- 6) Install the retainers with the 10 x 3/8" screws. A drop of penetrating oil on each screw will facilitate easy installation.

## **CHIMNEY DRAFTS**

If you suspect a draft problem in an existing chimney, determine the draft by using a water manometer (draft gauge). The draft should be measured with the stove at medium burn. After the measurement is completed, fill any holes that were made to take the reading by using a sheet metal screw of proper size. The draft should measure between .02" and .10" of water. If the draft is outside these limits, the stove may not operate properly. Drafts below .02" will cause excessive smoke spillage, incomplete combustion and fire start-up problems. A draft near the upper limit will contribute to the door glass staying clean.

## **OPTIONAL FAN ASSEMBLY**

Routine maintenance of the optional fan assembly on the back of the stove is not required. However, should it become necessary to replace the fan assembly, order an exact replacement from your local dealer. Contact a qualified electrical contractor for repair of electrical systems.

# TROUBLESHOOTING

Your Blaze King is designed to allow a wide selection of heat output levels. If you begin to lose control of the amount of heat the stove is emitting, determine the problem early so that major problems can be avoided.

The four major needs of a well-controlled fire are:

- 1) Knowledgeable operator.
- 2) Adequate air supply.
- 3) Firewood of good quality and proper size.
- 4) Clean chimney, properly sized and installed.

Considering all of the above, number one is the most important for the safe and efficient operation of any woodstove. Please study the operation instructions carefully. Consult your BLAZE KING dealer or call the Customer Service Department at Valley Comfort (250) 493-7444 if you have any questions not answered in this manual.

All of the four above-mentioned needs are interrelated. A deficiency in any one will effect all of the others. If you encounter a problem, determine the source of the problem and then follow-up by checking the other needs for possible problems.

## **PROBLEM: Chimney fire.**

Act immediately regardless of cause. Adjust combustion air Control to lowest setting, check loading door to be sure it is tightly closed. Make sure all persons are alerted and out of the house. Call Fire Department.

After the fire is out, have your chimney and flue connector inspected by a certified chimney sweep. A masonry chimney that is damaged should be repaired or rebuilt. A prefabricated chimney (factory built) that is damaged should be replaced. Any damage to the flue connector should be corrected before the system is used again.

Possible causes for a chimney fire, and remedies for those causes, can be found further in this section: "Excessive Creosote Formation", and "Spots of Creosote Accumulation in Chimney or Flue Connector".

## **PROBLEM: Not enough heat.**

### POSSIBLE CAUSES

Green or wet wood  
Obstruction in chimney or cap screen  
Heat exchange chamber filled with ash  
  
Thermostat not operating properly  
Poor draft caused by an oversize flue  
  
Strong, gusting winds causing downdraft in chimney  
Tightly sealed house, inadequate air supply  
  
Reloading too much wood on top of too few coals

### POSSIBLE SOLUTION

Use seasoned wood.  
Remove obstruction  
Clean heat exchanger chamber.  
(see Page 15)  
Consult your Blaze King dealer.  
Measure draft with Manometer. See  
CHECK YOUR CHIMNEY (Page 20)  
Consult your Blaze King dealer or a  
chimney sweep.  
Install wind-resistant chimney cap.  
Install a fresh air kit or open a  
window, slightly, near the stove.  
  
Allow a larger bed of coals to build up.  
(see Page 14).

POSSIBLE CAUSES

POSSIBLE SOLUTION

**PROBLEM: Too much heat.**

Thermostat not operating properly  
Loading door gasket leaking, admitting excess air into firebox  
Excessive draft in the chimney

Consult your Blaze King dealer.  
Replace door gasket and/or adjust door. (see Page 16).  
Measure draft with a Manometer.  
Consult your Blaze King dealer or a chimney sweep. Install a cap.  
Use larger diameter pieces.

Wood in too small pieces

**PROBLEM: Fans will not run, or there is no adjustment for fan speed**

POSSIBLE CAUSES

POSSIBLE SOLUTION

Consult your Blaze King dealer.

**PROBLEM: Excessive creosote formation.**

POSSIBLE CAUSES

POSSIBLE SOLUTION

Improper operation

Check combustion air control setting operating procedures.

Wood too green or wet

Use seasoned wood.

Poor draft caused by an oversize flue, etc

Measure draft with Manometer. See DRAFTS, Page 17. See CHECK YOUR CHIMNEY, Page 20. Consult your Blaze King dealer or a chimney sweep.

Chimney too cold or poorly insulated.

Upgrade chimney system. Consult your Blaze King Dealer or a chimney sweep

**PROBLEM: Spots of creosote accumulation in chimney or flue connector.**

POSSIBLE CAUSES

POSSIBLE SOLUTION

Air leaks in chimney or flue connector

Inspect chimney and/or flue connector.

Repair or replace as necessary.

Check to be sure that the flue connector is installed correctly. CAUTION: a leaking flue connector is a fire hazard and demands immediate attention.

**PROBLEM: Door glass quickly becomes coated with creosote.**

POSSIBLE CAUSES

POSSIBLE SOLUTION

Low thermostat setting

Turn the thermostat to the warmest setting during the first 20-30 minutes or until the fire is well established after each reloading.

Lowering the thermostat setting too far, too quickly

Turn the thermostat to the warmest setting the first 20-30 minutes or until the fire is well established after each reloading.

Obstruction in chimney or cap screen

Remove obstruction. Clean chimney and/or cap screen.

Heat exchanger chamber filled with ash

Clean heat exchanger chamber.

(See Page 15).

Poor draft caused by oversize flue, etc.

Measure draft with a Manometer. Some chimneys may need to be relined. Consult your Blaze King dealer or a chimney sweep.

## POSSIBLE CAUSES

Strong, gusting winds causing downdraft in chimney  
Tightly sealed house, inadequate air supply  
Burning poorly seasoned wet wood,

## POSSIBLE SOLUTION

Install wind-resistant chimney cap.  
Open a window, slightly, near the stove.  
Use seasoned wood with low pitch content or wood with high pitch content, such as some types of Pine

## PREPARATION AND ASSEMBLY

### **WARNING**

**IMPROPER ASSEMBLY AND/OR INSTALLATION OF YOUR BLAZE KING WOODSTOVE OR FAILURE TO OPERATE IT ACCORDING TO THE GUIDELINES DETAILED IN THESE INSTRUCTIONS, WILL VOID THE STOVE WARRANTY, CAN CAUSE A HOUSE OR CHIMNEY FIRE, AND MAY ENDANGER YOUR FAMILY. FOR YOUR SAFETY, FOLLOW THE ASSEMBLY AND INSTALLATION INSTRUCTIONS CAREFULLY. CONTACT LOCAL BUILDING OR FIRE OFFICIALS ABOUT RESTRICTIONS AND INSTALLATION INSPECTION IN YOUR AREA. PLEASE READ THIS ENTIRE MANUAL BEFORE YOU INSTALL AND USE YOUR NEW STOVE.**

DO NOT CONNECT THIS UNIT TO A CHIMNEY FLUE SERVING ANOTHER APPLIANCE

### **PLANNING FOR YOUR STOVE PLACEMENT**

As you plan your installation, consider the following;

- 1) Stove should be placed as central in the home as possible. consider safety, convenience and traffic flow.
- 2) Minimum clearances shown in figure 3 must be adhered to. The stove and chimney connector may be placed closer to the wall than shown in figure 3 if the wall is properly protected. Your Blaze King dealer can advise you on methods.
- 3) The dimensions and position of the floor protector.
- 4) The type of chimney system to be used.
- 5) Electrical Power. (Optional) The stove can be equipped with a fan assembly and a seven foot electrical cord. Do not route the cord in front of the stove.
- 6) If you have a forced air heating system, you can use the existing fan system to help circulate warm air throughout your house, but **DO NOT** connect any ducting between your heater and any other air distribution system.

### **CHECK YOUR CHIMNEY**

This stove may be connected to a lined masonry chimney or a listed high temperature prefabricated metal chimney labeled for use with solid fuel. Do not connect it to a chimney serving another appliance.

Before connecting any wood burning unit to an existing chimney, inspect the chimney to be sure that it is in good condition. There must be no cracks or holes. The cross-sectional area must not be less than that of the flue collar. Since an oversized flue contributes to the accumulation of creosote, the size of the flue should be checked to determine that it is not too large for the stove. Relining or rebuilding may be necessary to make the chimney safe, efficient, and in conformity with local codes. A proper chimney is crucial for safe, satisfactory operation of any wood heating system.

Be sure the Ash Clean Out Door for the masonry chimney is closed tightly. This door may be in the wall below the chimney in the room below the chimney or outside near the ground level of the chimney. This is frequently overlooked, and can cause severe drafting problems in masonry chimney

installations.

Chimney tops should NEVER be near trees or other tall objects that might cause downdrafts. The chimney MUST extend above the roof at least three feet or two feet above any area of the roof within ten feet of the termination of the chimney.

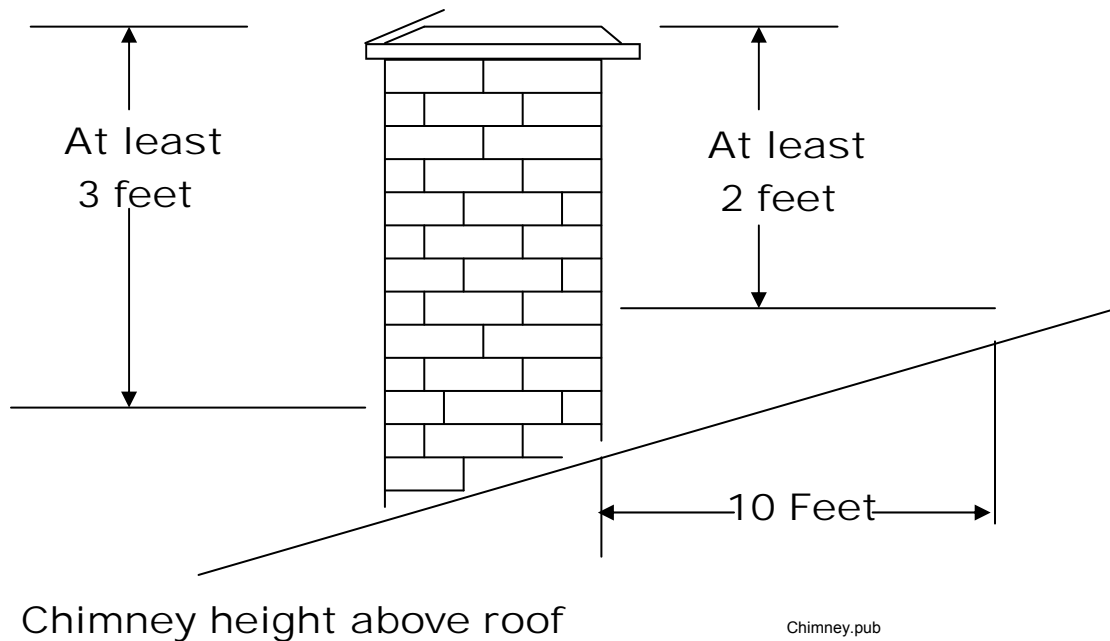

FIGURE 1

## COMBUSTION AIR REQUIRED

You must provide adequate outside air for proper combustion. Particularly in mobile homes, new homes or homes which have been weatherized and are very air tight. Exhaust fans, such as those installed in kitchen and bathrooms, can create a negative pressure in the room. This is a very serious situation as smoke and dangerous carbon monoxide gases could be drawn back into your home. You can obtain an outside air kit from your Blaze King dealer, which when properly installed will ensure adequate combustion air. In mobile home installations (only the catalytic model is mobile home approved), you must use the outside air kit.

## INSTALLATION

### GENERAL INSTRUCTIONS

Valley comfort Systems Inc. supports the Wood Energy Technology Transfer Inc. This organization provides training and certification for personnel involved in installation and maintenance of wood heating systems across Canada. For your safety and satisfaction your system must be properly installed.



## FLOOR PROTECTOR

The stove must be placed on a floor protector if the floor is wood or other combustible flooring. Any non-combustible material or a listed floor protector is acceptable.

To provide the proper clearances, the floor protector must be at least 18" in front of the stove base, 8" from each side of the stove,

The floor protector must extend to the wall under a wall exit installation and must extend 6" beyond each side of the horizontal section of chimney connector.

## CHIMNEY CONNECTOR

Single wall chimney connector must be minimum 26 MSG steel. Do not use aluminum or galvanized steel. Do not use chimney connector pipe as a chimney. Chimney connector sections must be attached to the stove and to each other with the crimped end toward the stove (FIGURE-2). This allows moisture to run into the stove and not onto the outside of the pipe. All joints should be secured with three metal screws.

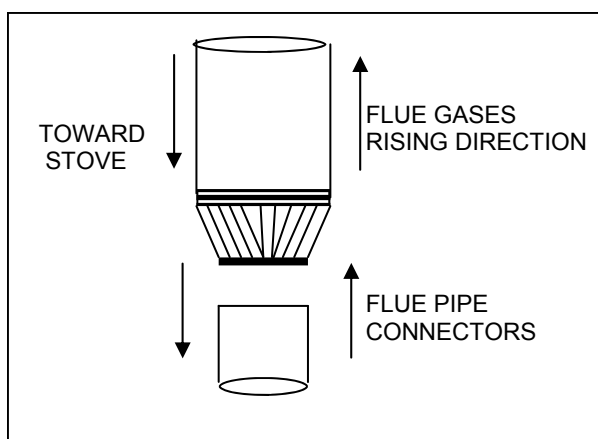

FIGURE 2

For proper operation the chimney connector should be as short as possible. Horizontal lengths of chimney connector should have an upward slope from the stove of 1/4 inch per foot.

Maintain 18 inches clearance between horizontal chimney connector and the ceiling unless a ceiling protection system is installed.

## CLEARANCES TO COMBUSTIBLE MATERIALS

If closer clearances are required a listed wall or pipe shield may be used to reduce the clearances shown in the following chart.

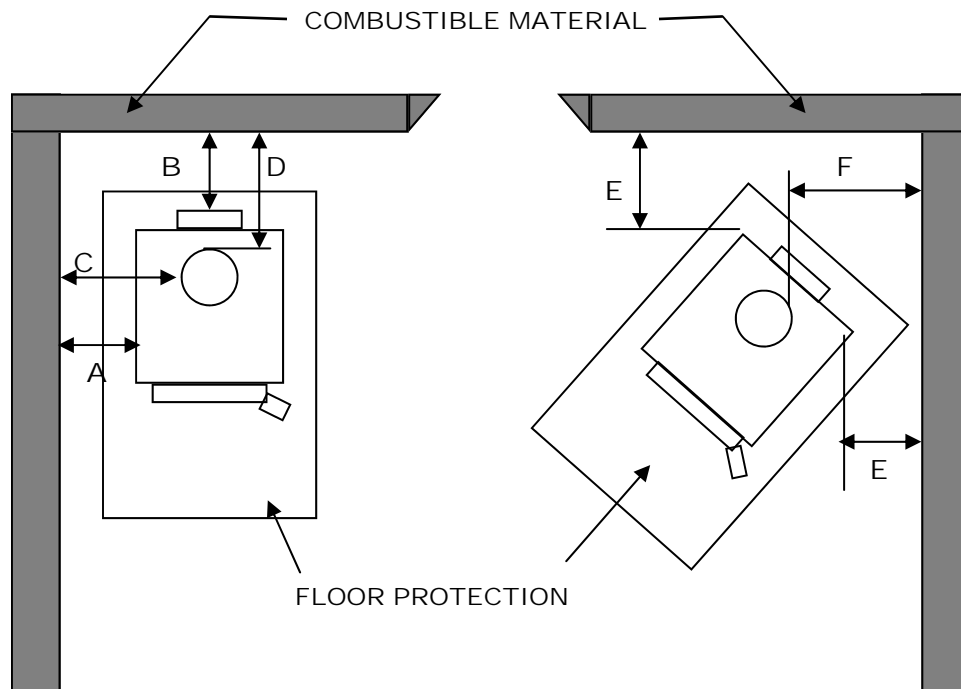

FIGURE 3

**MODEL KING KT 1102 (non catalytic)**

ROOF OR WALL EXIT CLEARANCES ARE THE SAME  
FOR WALL EXIT CLEARANCE ABOVE HORIZONTAL CONNECTOR 18"

	A	B	C	D	E	F
Parallel & corner	14"	7"	25"	14.5"	12"	23.5"
Parallel reduced side use side shields	8"	7"	18"	14.5"	n/a	n/a
Parallel & corner close clearance, use side shields & rear shield or fan	8"	6"	18"	13.5"	6"	17.5"
Alcove	8"	6"	n/a	n/a	n/a	n/a

Alcove minimum size 47" wide, 76" high, maximum 48" depth

Alcove installation requires side shields & rear shield or fan.

## MODEL PRINCESS PT1003 (non catalytic)

ROOF OR WALL EXIT CLEARANCES ARE THE SAME

FOR WALL EXIT CLEARANCE ABOVE HORIZONTAL CONNECTOR 18"

	A	B	C	D	E	F
Parallel & corner	12"	7"	22"	14.5"	11"	22.5"
Parallel reduced side use side shields	7"	7"	17"	14.5"	n/a	n/a
Parallel & corner close clearance, use side shields & rear shields or fan	7"	6"	16"	13.5"	6"	16.5"
Alcove Alcove minimum size 47"wide, 76" high, 48" maximum depth Alcove installation requires side shields & rear shield or fan	7"	6"	n/a	n/a	n/a	n/a

### INSTALLATION USING METAL CHIMNEY

When a metal prefabricated chimney is used, the manufacturer's installation instructions must be followed precisely. Maintain the proper clearance to combustibles as recommended by the manufacturer. The chimney must be the required height above the roof or other obstructions, see figure 1.

- 1) Position your stove in the desired location and use a plumb line to mark the spot directly above your stove where the chimney will exit the room.
- 2) Check to see that the area where the chimney will penetrate the wall or ceiling is clear before cutting. Maintain structural integrity of the wall or ceiling.
- 3) Mark the exact location for the floor protection. It must extend 16" in front and 6" on each side and 6" to the rear of the stove. If you are using a wall exit the floor protector must extend to the wall below the pipe and 6" on either side. Mark the location for combustion air supply.
- 4) Set the stove aside and install the chimney in accordance with the chimney manufacturers instructions.
- 5) Install the combustion air supply if applicable.
- 6) Install the floor protection.
- 7) Position the stove in its final location and connect the chimney connector pipe (see Figure 2) and the combustion air supply. Note: the chimney connector pipe is installed with the crimped end down toward the stove, and each joint must be secured with 3 sheet metal screws.
- 8) Contact the local authority for a final inspection.

Carefully read the operating instruction in the front section of this manual.

Thank you! Have a cozy safe winter.

## INSTALLATION USING MASONRY CHIMNEY

The masonry chimney must meet local building codes covering solid fuel appliance. The chimney must be the required height above the roof and other obstructions, see figure 1.

- 1) Position your stove in the desired location and ensure that a proper chimney connector installation is possible. Horizontal runs should be as short as possible and slope up 1/4" per foot run.
- 2) The chimney connector must not penetrate a combustible wall without using an acceptable thimble system. Check with your Blaze King dealer, your building inspector or a fire protection officer for local requirements
- 3) Mark the exact location for the floor protection. It must extend 16" in front and 6" on each side and 6" to the rear of the stove. If you are using a wall exit the protector must extend to the wall below the pipe and 6" on either side. Mark the location for combustion air supply.
- 4) Set the stove aside and install the combustion air supply if applicable.
- 5) Install the floor protection.
- 6) Position the stove in its final location and connect the chimney connector pipe (see figure 2) and the combustion air supply.  
**Note:** the chimney connector pipe is installed with the crimped end down toward the stove and each joint must be secured with 3 sheet metal screws.
- 7) Contact the local authority having jurisdiction for a final inspection.

Carefully read the operating instruction in the front section of this manual.

Thank you! Have a cozy safe winter.

# PRINCESS PT1003 BRICK LAYOUT

## BRICK SIZES

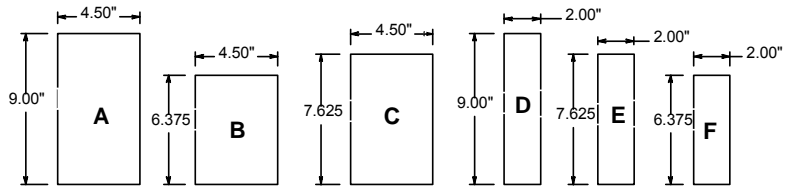

## BACK

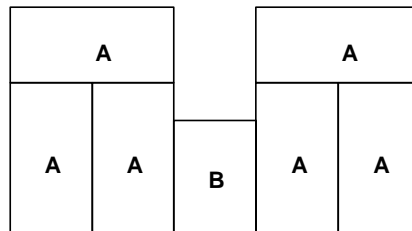

## LEFT SIDE

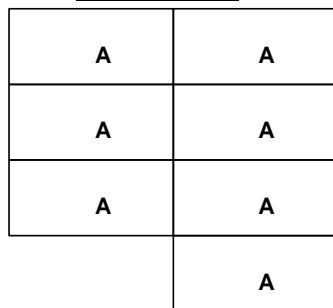

## BOTTOM

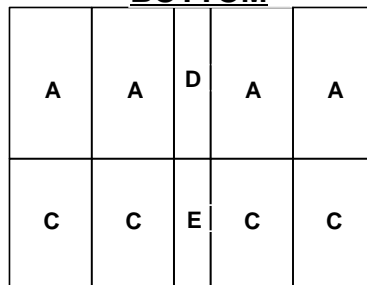

## RIGHT SIDE

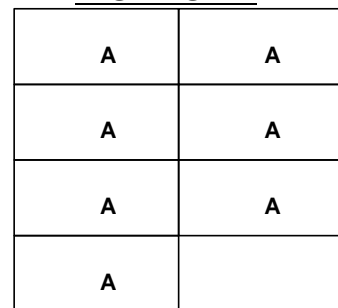

## FRONT

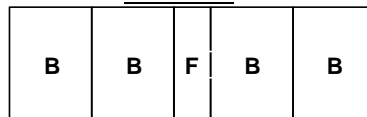

## BAFFLE

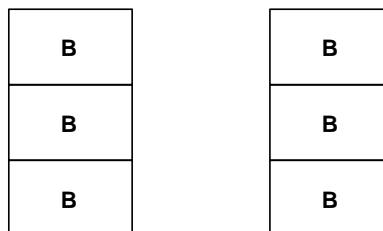

# KING KT1003 BRICK LAYOUT

## BRICK DIMENSIONS

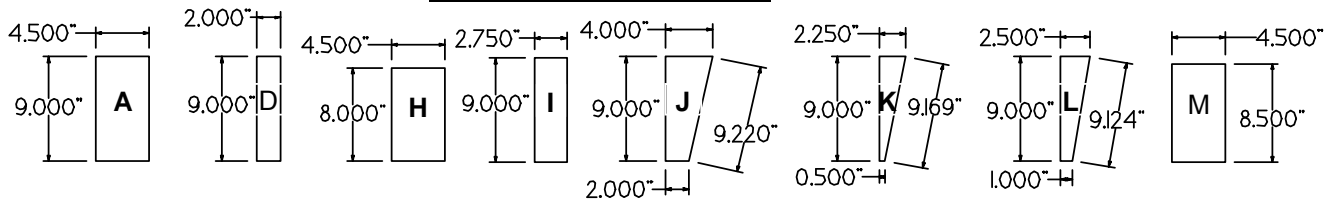

### BACK

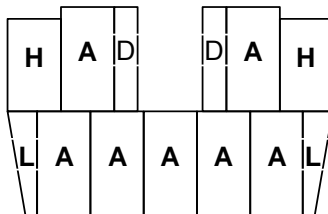

### LEFT SIDE

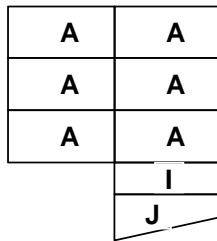

### BOTTOM



### RIGHT SIDE

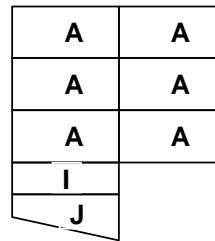

### FRONT

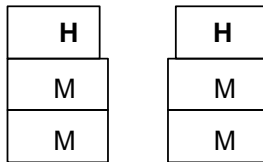

### BAFFLE