

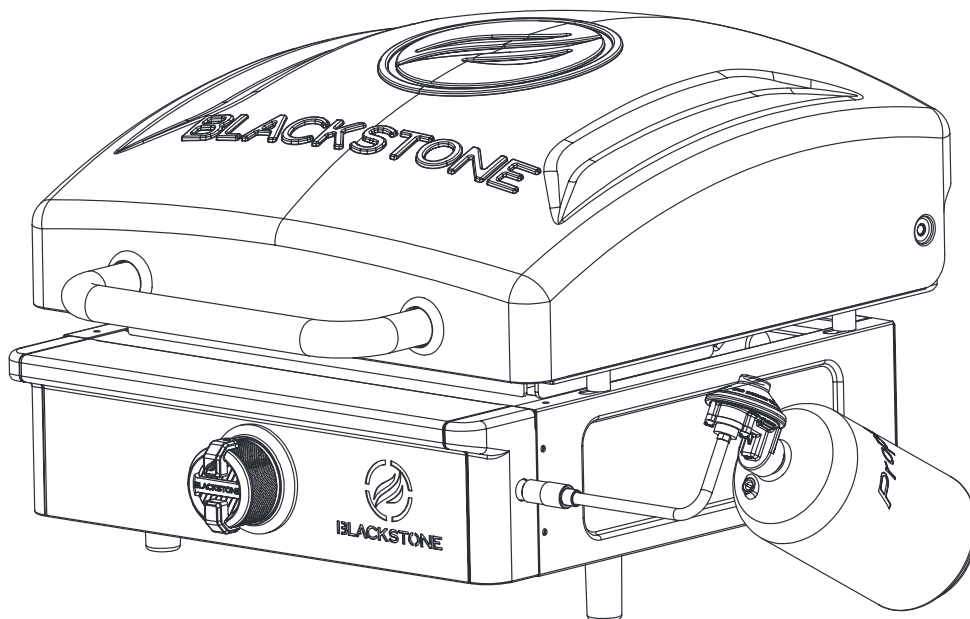

MODEL: 1890 ^{v06}



ENGLISH

OWNER'S MANUAL

17" GRIDDLE WITH HOOD

TABLE OF CONTENTS	
IMPORTANT SAFETY INFORMATION	02
ACTIVATE YOUR WARRANTY	03
ASSEMBLY GUIDE	04
USING YOUR BLACKSTONE	06
TROUBLESHOOTING	12



For the latest version of this manual, scan this code or visit BlackstoneProducts.com/support

IMPORTANT:
 This instruction manual contains important information necessary for the proper assembly and safe use of the appliance.
 Read and follow all warnings and instructions before assembling and using the appliance.
 Follow all warnings and instructions when using the appliance.
 Keep this manual for future reference.
 Installer/Assembler: Leave these instructions with the consumer.

SAFETY ALERT KEY

- ⚠ DANGER**
 Indicates a hazardous situation that, if not avoided, will result in death or serious injury.
- ⚠ CAUTION**
 Indicates a hazardous situation that, if not avoided, could result in minor or moderate injury.

- ⚠ WARNING**
 Indicates a hazardous situation that, if not avoided, could result in death or serious injury.

- NOTICE**
 Indicates information considered important, but not hazard-related (e.g. messages related to property damage).

IMPORTANT SAFETY INFORMATION

⚠ DANGER

If you smell gas:

- Shut off gas to the appliance.
- Extinguish any open flame.
- Open hood.
- If odor continues, keep away from the appliance and immediately call your gas supplier or your fire department.

Failure to follow these instructions could result in fire or property damage, personal injury or death.

⚠ DANGER

- NEVER operate this appliance unattended.
- NEVER operate this appliance within 10 ft (3.0 m) of any structure, combustible material or other gas cylinder.
- NEVER operate this appliance within 25 ft (7.5 m) of any flammable liquid.
- If a fire should occur, keep away from the appliance and immediately call your fire department. DO NOT attempt to extinguish an oil or a grease fire with water.

Failure to follow these instructions could result in fire or property damage, personal injury or death.

⚠ WARNING

- DO NOT store or use gasoline or other flammable liquids or vapors in the vicinity of this or any other appliance.
- An LPG cylinder not connected for use shall not be stored in the vicinity of this or any other appliance.

GAS APPLIANCE SAFETY

- The use of alcohol, prescription, or non-prescription drugs may impair the consumer's ability to properly assemble or safely operate the appliance.
- Keep children and pets away from the appliance at all times.
- Have a type BC or ABC fire extinguisher readily available.

DO NOT USE FOR PURPOSES OTHER THAN INTENDED:

- DO NOT modify this appliance.
- DO NOT use for commercial cooking.
- DO NOT use this appliance as a heater.

THIS APPLIANCE SHALL BE USED OUTDOORS ONLY.

- DO NOT use this appliance inside buildings, garages, or any other enclosed area.
- DO NOT install this appliance in or on a boat.
- DO NOT install this appliance in or on a recreational vehicle.

MAINTAIN PROPER CLEARANCES FROM COMBUSTIBLE MATERIAL:

- DO NOT use this appliance on or under any apartment or condominium balcony or deck.
- DO NOT use this appliance under overhead combustible construction.
- DO NOT obstruct the flow of combustion and ventilation air.
- DO NOT operate this appliance any closer than 36 in (1 m) from the sides and back of the appliance.

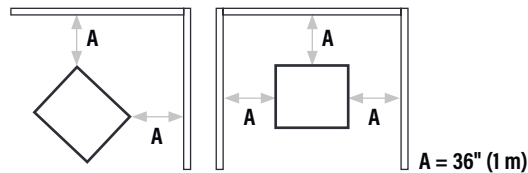

INSTALLATION MUST CONFORM WITH LOCAL CODES

In the absence of local codes, installation must conform with:

- National Fuel Gas Code, ANSI Z223.1/NFPA 54, Storage and Handling of Liquefied Petroleum Gases, ANSI/NFPA 58; or*
- Natural Gas and Propane Installation Code, CSA B149.1; Propane Storage and Handling, CSA B149.2; or*
- The Standard for Recreational Vehicles, ANSI A119.2/NFPA 1192; and Recreational Vehicle Code, CSA Z240 RV Series, as applicable.*



ACTIVATE YOUR WARRANTY

The North Atlantic Imports LLC 1-Year Warranty covers replacement parts up to one year after the date of purchase.

TO ENABLE THIS WARRANTY, YOU WILL NEED TO PROVIDE:

👉 Your appliance's Serial Number

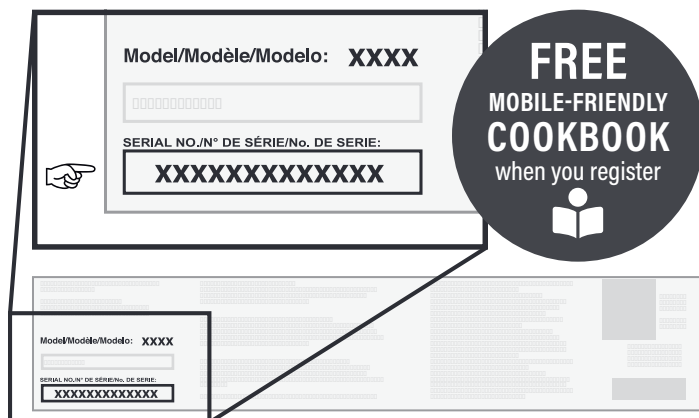

The Serial Number can be found on your appliance's Manufacturer Label.

(The Manufacturer Label is a large silver sticker found on the body of your appliance.)



Register your appliance at
BlackstoneProducts.com/register

WARRANTY OVERVIEW

North Atlantic Imports, the manufacturer, will warranty for one year from purchase all parts, workmanship, and finishes. It will be the manufacturer's option as to whether to repair or replace any of the above items. All warranties are limited to the original purchaser only. This warranty does not cover any liability on the part of North Atlantic Imports, its agents or employees, for any indirect or consequential damages for breach of warranty. The purchaser must follow the manufacturer's usage instructions.

Under no circumstances is the manufacturer responsible for damages from the failure to operate the cooking station properly. It is the responsibility of the purchaser to establish the warranty period by verifying the original purchase date with original sales receipt.



DETAILED EXPLANATION OF THE WARRANTY

North Atlantic Imports LLC warrants to the owner that the product covered by this agreement is free from defects in material and workmanship under normal use and service for which it was intended if, but only if, it has been operated in accordance with North Atlantic Imports LLC instructions exclusively for domestic use, and not for private or public club, institutional or commercial purposes.

North Atlantic Imports LLC's obligation under this warranty is limited to replacing or repairing, free of charge, any part or parts that may prove, to the satisfaction of North Atlantic Imports LLC, to be defective under normal home use and service within the following stated periods of time from the date of purchase; for one year from purchase, all parts, finish, and workmanship. Should any failure to conform to this warranty become apparent during applicable warranty periods stated above, the original purchaser must notify North Atlantic Imports LLC of breach of warranty within the applicable warranty period.

North Atlantic Imports LLC shall upon notice and compliance by the original purchaser with such instructions, correct such nonconformity by repair or replacement of the defective part or parts.

Correction in the manner provided above shall constitute a fulfillment of all obligations of North Atlantic Imports LLC with respect to the quality of the product.





North Atlantic Imports LLC does not warrant this equipment to meet the requirement of any safety code of any state, municipality or other jurisdiction, and the original purchaser assumes all risk and liability whatsoever resulting from the use thereof, whether used in accordance with North Atlantic Imports LLC instructions or otherwise.

This warranty does not cover and is intended to exclude any liability on the part of North Atlantic its agents, servants or employees whether under this warranty or implied by law for any indirect or consequential damages for breach on any warranty. The purchaser must establish all applicable warranty periods pursuant to this warranty by verifying the original purchase date by producing the dated sales receipt. This warranty shall not apply to this product or any other part thereof which has been subject to accident, negligence, alteration, abuse, or misuse or which has been repaired or altered without North Atlantic written consent, outside of North Atlantic Imports LLC factory. The full manufacturer warranty is not valid for griddles purchased from unlicensed, third-party resellers, purchased at a discount due to missing or damaged parts, or purchased as a floor model; at the discretion of North Atlantic Imports.

North Atlantic Imports LLC makes no warranty whatsoever in respect to accessories or parts not supplied with it. This warranty shall apply only within the boundaries of the United States of America and Canada. This warranty gives the original purchaser specific rights, and the original purchaser may also have other rights, which vary from state to state.

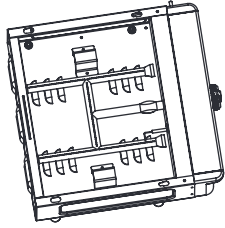
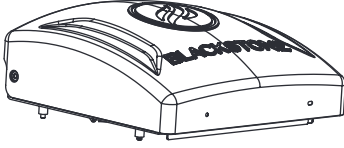
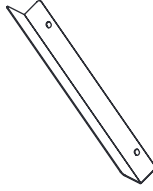
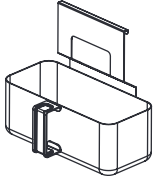
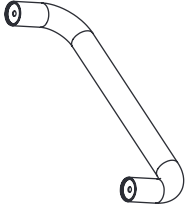
ASSEMBLY GUIDE

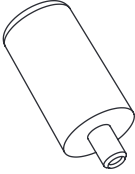
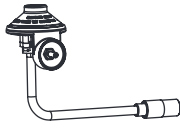
PARTS LIST

<p>1 Body (1 piece)</p> 	<p>2 Griddle top & Hood (1 piece)</p> 	<p>3 Stopper bracket (1 piece)</p> 	<p>4 Grease cup (1 piece)</p> 		
<p>5 Hood handle (1 piece)</p> 	<p>6 Handle grommets (2 pieces)</p> 	<p>7 Griddle feet (4 pieces)</p> 	<p>8 Regulator (1 piece)</p> 	<p>9 M8 Flange nuts (4 pieces)</p> 	<p>10 M6 Screws (2 pieces)</p> 

ASSEMBLY INSTRUCTIONS

Find a large, clean area to assemble your appliance.
Remove all packing material before assembling.

CAUTION

Sharp edges. Wear gloves while assembling.

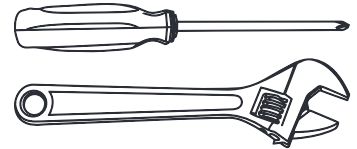

NOT INCLUDED:
LPG cylinder
Size: 4 x 8 in (10 x 20 cm), 1 lb (453 g)

TOOLS NEEDED:
Phillips head screwdriver &
Adjustable wrench

STEP 01 Place griddle on a smooth flat surface and attach the four (4) griddle feet and the four (4) M8 flange nuts to the bottom of the griddle in the pre-threaded holes.

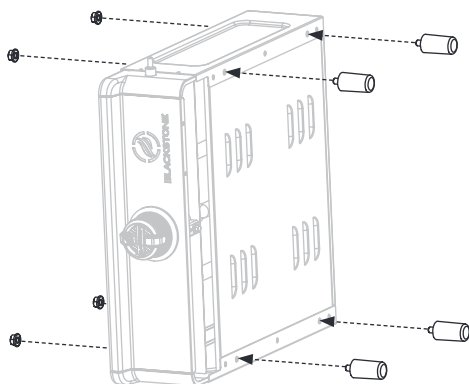

STEP 02 Ensure that the fuel nozzle is housed within the burner opening.

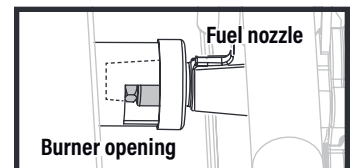
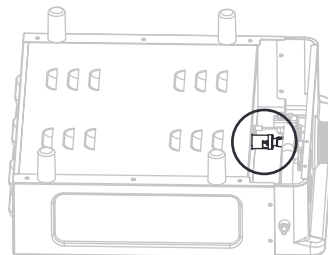

ENGLISH

STEP 03 Turn the griddle over so it stands on its feet. Ensure that the ignition needle is positioned 3-7mm above the burner tube.

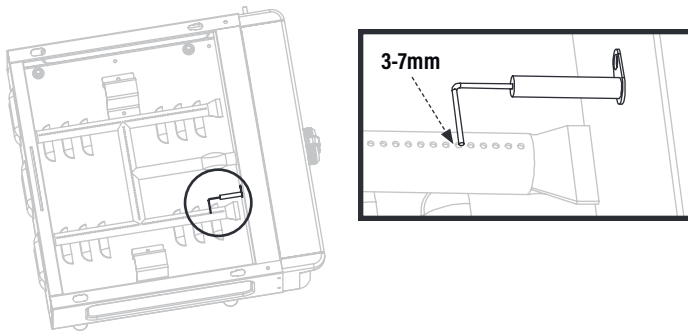

STEP 04 Place the griddle top onto the griddle body by aligning the four pins to the holes of the body.

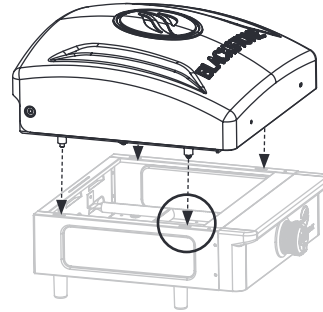

Make sure the front pins are fully seated in the holes, then push the griddle top back to lock the griddle in place.

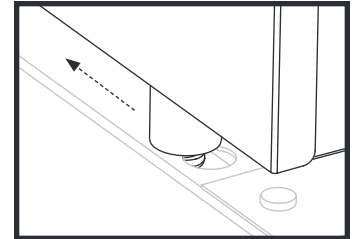

STEP 05 Use two (2) M6 screws to attach the hood handle, hood handle bezels and stopper bracket to the hood.

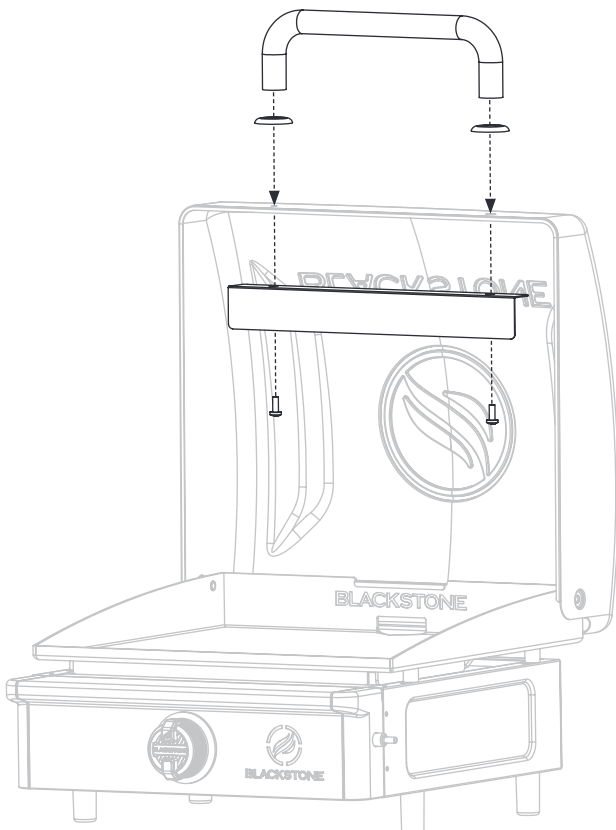

STEP 06 Hang the grease cup on the back of the griddle top.

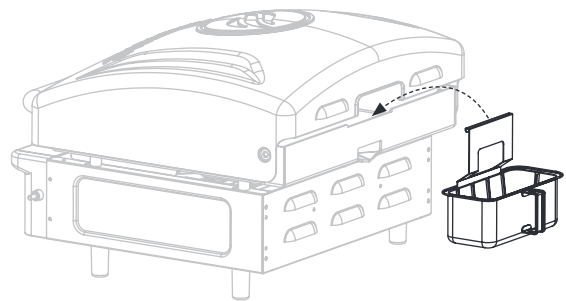

ENGLISH

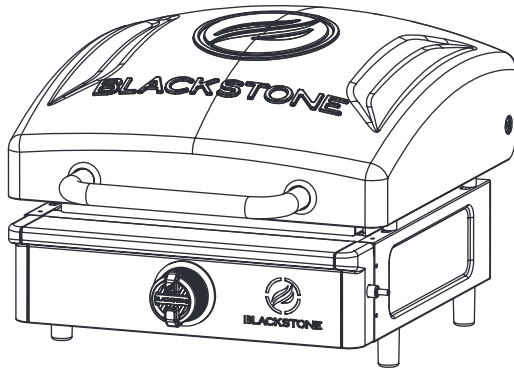
STEP 07 Proceed to **USING YOUR BLACKSTONE.****NOTICE**

Place appliance on a heat-resistant and flame-resistant surface while in use.

NOTICE

DO NOT leave the hood closed for more than 10 minutes while cooking.

USING YOUR BLACKSTONE

CONNECT THE LPG CYLINDER

1 LB (453 G)

STEP 01 Screw in the LPG cylinder into the gas regulator, turning the cylinder clockwise.

The regulator may make a humming or whistling noise during operation. This will not affect safety or use of the appliance.

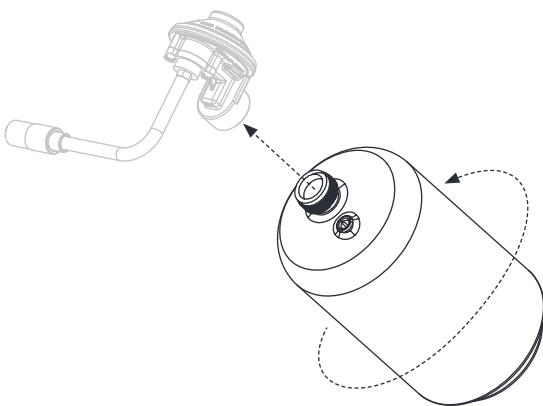

REGULATOR SAFETY

⚠ WARNING

Cross threading can occur if you force thread a connection at an improper angle. This will damage the threads, lead to propane leaking, and potentially result in a build-up of fuel that can ignite.

DO NOT cross thread the connection between your LPG cylinder and regulator or regulator and gas rail.

⚠ WARNING

If you can not connect the regulator, DO NOT use the regulator.

Regulator must be replaced with a Blackstone approved model by a professionally licensed, authorized dealer.

Use this appliance, as purchased, only with gas and regulator/valve assembly supplied.

If regulator fails in unit, it must be replaced with a Blackstone approved model (found on your Manufacturer label) by a professionally licensed, authorized dealer. Failure to comply will void the warranty.



STEP 02 Insert the regulator and LPG cylinder into the gas line of the appliance. Turn the collar of the regulator clockwise to secure it to the gas line.

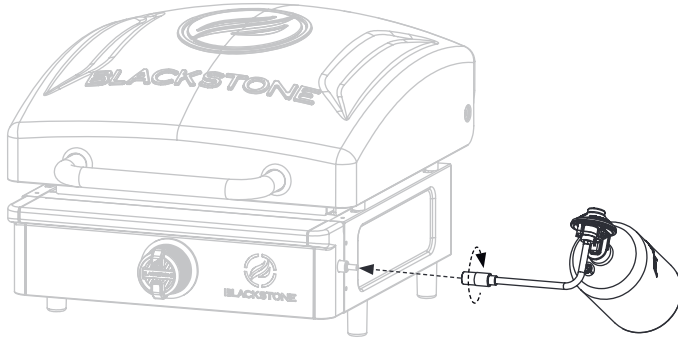

LPG CYLINDER SAFETY

- The LPG supply cylinder to be used must be constructed and marked in accordance with the specifications for LP gas cylinders, U.S. Department of Transportation (DOT) or the Standard for Cylinders, Spheres and Tubes for the Transportation of Dangerous Goods, CAN/CSA-B339.
- Only LPG cylinders marked "propane" shall be used.
- The cylinder used, if in excess of 2.2 lb (1.00 kg) propane capacity, must include a collar to protect the cylinder valve.
- The LPG cylinder supply system must be arranged for vapor withdrawal.

Always keep new LPG cylinders in upright position during use, transit or storage.

Ensure that the LPG cylinder is positioned below the regulator. (If the liquid level of the propane is above the regulator, the regulator will frost.)

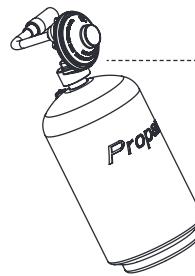

The gas regulator is intended to be used at an angle towards the rear of the appliance.

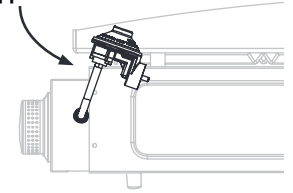

IF FROSTING PERSISTS AFTER BOTTLE IS ANGLED CORRECTLY:

STEP 01 Turn off the appliance and disconnect LPG cylinder immediately.

This indicates a problem with the LPG cylinder and it should not be used on any product.

STEP 02 Return LPG cylinder to supplier.

LEAK TEST INSTRUCTIONS

NOTICE

DO NOT use household cleaning agents. Damage to gas valve and regulator components may result. Use a clean paintbrush and a 10/90 mild soap and water solution to perform the leak test.

STEP 01 Turn the control knobs to OFF.

STEP 02 Connect the LPG cylinder to the regulator. Connect the regulator to the appliance.

The regulator may make a humming or whistling noise during operation. This will not affect safety or use of the appliance.

STEP 03 Brush soapy solution onto joint areas of valves and regulator.

Leaks are indicated by growing bubbles.

STEP 04 If growing bubbles appear, re-tighten connections.

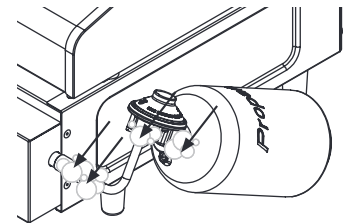

⚠ WARNING

If leaks cannot be stopped, DO NOT try to repair. Regulator must be replaced with a Blackstone approved model.

ENGLISH

FIRST TIME CLEANING

CLEANING YOUR GRIDDLE TOP

NOTICE

Soap will ruin a seasoned griddle. This is the only time you should use soap on the griddle cooking surface.

- STEP 01** Wash the griddle cooking surface with hot, soapy water.
- STEP 02** Rinse and dry completely.

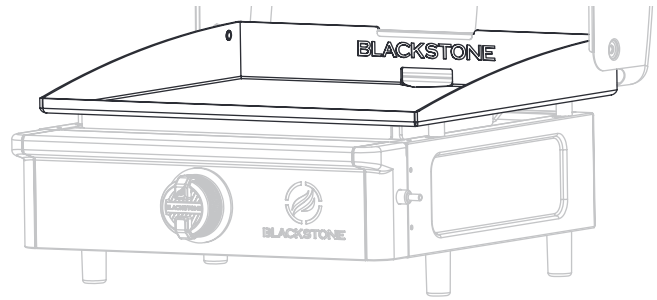

IGNITION INSTRUCTIONS

1. CHECK VALVES

- STEP 01** Turn knob to OFF position.
- STEP 02** Push in knob and release. Knob should spring back. If knobs DO NOT spring back, replace valve assembly before using appliance.
- STEP 03** Rotate knob to LOW then turn back to OFF. Knob should turn smoothly.

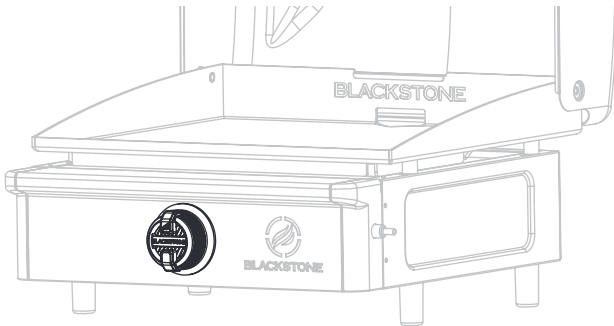

2. PIEZO-ELECTRIC GRIDDLE IGNITION

⚠ DO NOT lean over the appliance while lighting.

- ➊ Push the control knob in to start gas flowing.
- ➋ Turn the control knob counter-clockwise to activate the starter.
- ➌ Adjust the temperature to desired level.

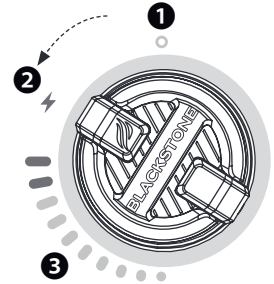

3. CHECK BURNER FLAME

Always check burner flame before use.

- STEP 01** Light burners and rotate knobs from HIGH to LOW.
- STEP 02** Look below the cooking top to view burners. When knob is at HIGH, flames should be larger than when knob is at LOW.

⚠ WARNING

A clogged burner can lead to a fire beneath the appliance. Burner should be removed and cleaned annually or whenever heavy build-up or insects/insect nests are found.

HEALTHY BURNER FLAME PATTERN

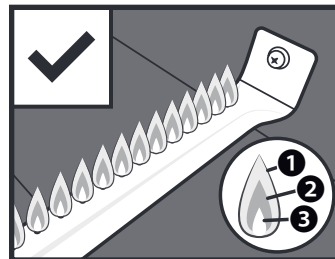

- ➊ Flickers of yellow color.
- ➋ Dark blue color.
- ➌ Vibrant blue.

BURNER FLAMES ARE YELLOW OR IRREGULAR

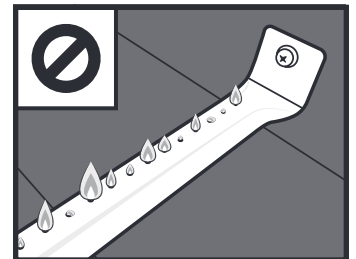

If there is a sudden drop or low flame issue, please reference the Troubleshooting chapter.



GRIDDLE SEASONING INSTRUCTIONS

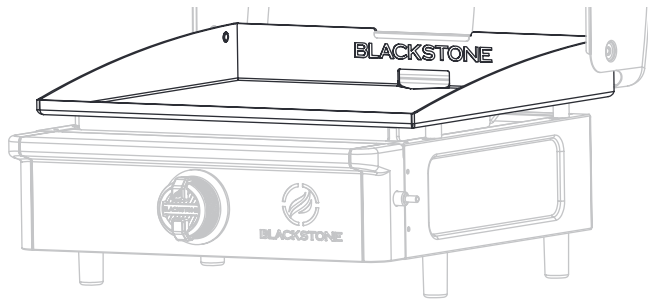

WHAT OIL IS BEST TO USE?

- Blackstone Seasoning and Cast Iron Conditioner.
- Any plant-based cooking oil.
- Rendered animal fat with no additives.

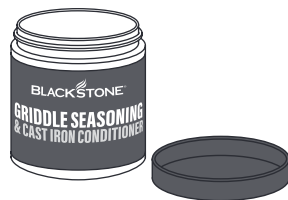

VIDEO TUTORIAL

How to Season a New Blackstone Griddle
 ▶ [youtube.com/watch?v=VspmDVnj2pl&t=3s](https://www.youtube.com/watch?v=VspmDVnj2pl&t=3s)

STEP 01 Wipe any debris off griddle top.



STEP 02 Set your griddle to high heat until your griddle top changes color. (~10 min)



STEP 03 Use tongs to hold a paper towel or cotton cloth and spread 2-3 tablespoons of your seasoning oil across the entire griddle top.
 When seasoning your griddle top, remember to use a thin and even layer of oil—the thinner the layer of oil, the easier it will be to burn it off.



STEP 04 The griddle top is ready for another layer of oil when it stops smoking. Repeat **STEP 03** 3-4 times, or until the griddle surface is black.



SEASONING TROUBLESHOOTING

THERE IS A BROWNISH RESIDUE ON THE GRIDDLE SURFACE:

POSSIBLE CAUSES

- Too much oil was used.
- You turned off the heat too soon.

SOLUTION

- STEP 01** Turn your griddle on high and let it heat for 10-15 minutes.
- STEP 02** Scrape off as much of the thickened and partially cooked oil as you can.
- STEP 03** Re-season with a very thin layer of oil.

THE EDGES OF THE GRIDDLE SURFACE ARE NOT BLACK:

After using your griddle for multiple cooks, the seasoning will even out and improve.

PREVENTING RUST

Use your griddle frequently. Every time you cook, you are adding to the seasoning, which makes rust less likely.

NOTICE

If you live in a humid or coastal climate, your griddle may require more frequent seasonings between uses.

If rust appears on the griddle surface, rub it off with steel wool, low grit sandpaper or the **Blackstone Pumice Stone** and re-season the surface.

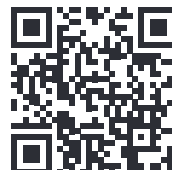

VIDEO TUTORIAL

Recovering your Blackstone Griddle Top
 ▶ [youtube.com/watch?v=thPE2lgnSil](https://www.youtube.com/watch?v=thPE2lgnSil)

COOKING ON YOUR BLACKSTONE

⚠ DANGER

Flammable items can spontaneously combust if placed near the appliance. DO NOT place flammable items such as aerosol containers, oily or greasy towels near the cooking surface.

⚠ CAUTION

This appliance will be hot during and after use. DO NOT handle hot parts with unprotected hands. Use long-handled cooking utensils and oven mitts.

NOTICE

DO NOT store any items within 3 in (8 cm) of the cooking surface while in use.

IF GREASE OR OTHER HOT MATERIAL DRIPS ONTO VALVE, HOSE OR REGULATOR:

STEP 01 Turn off gas supply immediately.

STEP 02 Determine the cause and correct it.

STEP 03 Clean and inspect valve, hose and regulator.

STEP 04 Perform a leak test. (Please reference the Leak Test Instructions in **USING YOUR BLACKSTONE.**)

VIDEO RECIPES

Find recipes and cooking tips at:

[BlackstoneProducts.com/blogs/recipes](https://www.blackstoneproducts.com/blogs/recipes)

[youtube.com/c/BlackstoneGriddles](https://www.youtube.com/c/BlackstoneGriddles)

[facebook.com/blackstoneproducts](https://www.facebook.com/blackstoneproducts)



STRAWBERRIES AND CREAM PANCAKES
Breakfast

OKLAHOMA FRIED ONION BURGER
Lunch



TACOS BORRACHOS
Dinner

CLEANING YOUR APPLIANCE

Clean your appliance after each use, after it is cool to the touch.

- DO NOT use abrasive pad on areas with graphics.
- If a bristle brush is used to clean any of the cooking surfaces, ensure no loose bristles remain on cooking surfaces prior to cooking.

⚠ WARNING

Grease build up can cause a fire. Clean any part of the appliance that gets hot and experiences grease build up after each use.

PLASTIC PARTS & PAINTED SURFACES:

Wash with warm soapy water and wipe dry with a non-abrasive cloth.

NOTICE

DO NOT use Citrisol, abrasive cleaners, or a concentrated cleaner on plastic parts. This may result in damage to and failure of parts.

FOR EVERY SURFACE

The **Blackstone Degreaser and Cleaning Spray** is gentle enough to clean every surface of your appliance. Use it on the cooking surface, the appliance frame, or anywhere that experiences a build up of grease.



APPLIANCE STORAGE

⚠ WARNING

DO NOT move the appliance when in use. Allow the appliance to cool to 115°F (45°C) before moving or storing.

COVER FIT GUIDE

Always cover your appliance when stored outdoors.



To find a cover that will fit your appliance, visit [BlackstoneProducts.com/support](https://www.blackstoneproducts.com/support).



CLEANING YOUR GRIDDLE TOP

Clean griddle top after each use, while still warm.

- DO NOT use soap on the griddle top. This will destroy the griddle's seasoning.
- The grease cup must be removed and emptied after each use.

⚠ CAUTION

Grease cup will be hot during and after use. DO NOT remove the grease cup until the griddle has completely cooled.



VIDEO TUTORIAL

How to Clean your Blackstone Griddle

▶ [youtube.com/watch?v=-ledu9z6NPY](https://www.youtube.com/watch?v=-ledu9z6NPY)

STEP 01 Push loose food debris into the grease cup with spatula or straight metal scraper.



STEP 02 Wipe down griddle top with paper towel.



STEP 03 Apply a few tablespoons of water to the griddle surface, then scrape the water and debris into the grease cup.

(For stuck-on food residue, use a bit of coarse salt.)



STEP 04 Wipe again with a paper towel and dry completely.



STEP 05 Apply thin coat of cooking oil to maintain seasoning and protect the griddle top.

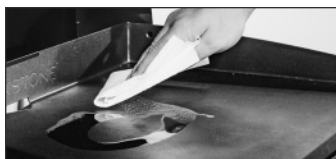

DISCONNECT THE LPG CYLINDER 1 LB (453 G)

STEP 01 Ensure that the control knob(s) are turned to OFF.

STEP 02 Once the appliance has cooled, disconnect the regulator from the gas line by unscrewing the collar.

STEP 03 Unscrew the LPG cylinder from the regulator.

STEP 04 Place dust cap on LPG cylinder valve outlet whenever cylinder is not in use.

Only install the type of dust cap on cylinder valve outlet that is provided with the cylinder valve. Other types of caps or plugs may result in leakage of propane.

STORING LPG CYLINDERS

⚠ WARNING

- DO NOT store a spare LPG cylinder under or near this appliance.
 - DO NOT fill an LPG cylinder beyond 80% full.
- If the information above is not followed exactly, a fire causing death or serious injury may occur.

- The LPG cylinder must be disconnected when the appliance is not in use.
- Only store the appliance indoors if the LPG cylinder is disconnected and removed from the appliance.

TROUBLESHOOTING

IGNITION TROUBLESHOOTING

BURNER WILL NOT IGNITE:

If ignition does not occur in 5 seconds:

STEP 01 Turn the burner control knob OFF.

STEP 02 Wait 5 minutes.

STEP 03 Repeat the lighting procedure.

If this does not work, to determine the cause, please try to ignite your appliance with a match.

MATCH LIGHTING INSTRUCTIONS

Before beginning, check for gas leaks. Open hood (if applicable).

STEP 01 Turn control knob to OFF position.

STEP 02 Light a match (or long lighter) no shorter than 11 inches long.

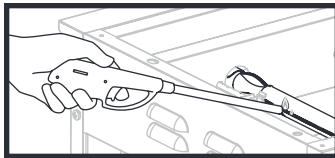

STEP 03 Place the flame next to the burner.

STEP 04 Push in and turn the control knob to start gas flowing. Ensure burner lights and stays lit.

IF YOU CAN IGNITE YOUR APPLIANCE WITH A MATCH:

POSSIBLE CAUSES

Ignitor wire misaligned.

SOLUTION

Ensure that the ignition needle is positioned 3-7mm away from the burner tube, and above a burner hole.

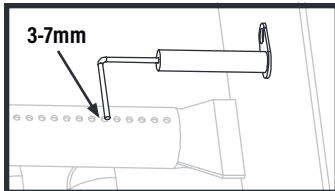

Damage to the ignition system.

Contact customer service for replacement parts.

IF YOU CAN NOT IGNITE YOUR APPLIANCE WITH A MATCH:

POSSIBLE CAUSES

Burner tubes are not receiving fuel.

SOLUTION

Clean the burner assembly to remove the obstruction.

GAS FLOW TROUBLESHOOTING

BURNER FLAMES ARE YELLOW OR IRREGULAR:

- Appliance will not achieve a high heat or heats unevenly.
- Burner flames start strong, then immediately drop to low even when burner is set to high position.
- Flame height drops when a second burner is lit.
- Flames DO NOT extend the full length of the burner, or only run on one side of the burner.
- Burner flames are inconsistent.

POSSIBLE CAUSES

Obstructions in the burner, gas jets, or fuel rail.

LPG cylinder is empty or low.

The regulator's flow limiting device was triggered.

SOLUTION

Clean the burner, jets, and gas hose.

Refill or replace the LPG cylinder.

Reset the safety system:

STEP 01 Turn OFF the appliance, close the LPG cylinder valve, and disconnect the regulator from the LPG cylinder.

STEP 02 Wait five minutes to allow the pressure to dissipate, then reconnect the regulator to the LPG cylinder and slowly open the OPD hand wheel one half turn.

STEP 03 Ignite your appliance.

Regulator stuck in safety position.

Contact customer service for replacement parts.

A FLAME IS COMING OUT OF THE AIR GATE:

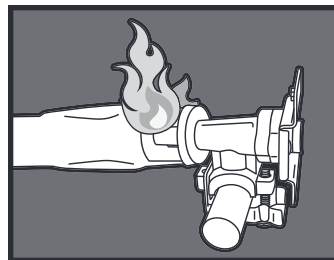

POSSIBLE CAUSES

Something is blocking the venturi in the burner.

SOLUTION

Clean the burner assembly to remove the obstruction.

ENGLISH



CLEANING THE BURNER ASSEMBLY



VIDEO TUTORIAL

How to Clean Your Burner Tube

▶ [youtube.com/watch?v=xKQTCrFCzf8](https://www.youtube.com/watch?v=xKQTCrFCzf8)

STEP 01 Ensure that the gas is turned OFF at control knobs and gas supply. Remove the cooking top.

STEP 02 Carefully detach and remove the burner.



STEP 03 Clean the inside of the burner:

- Run a narrow bottle brush through each burner tube several times. (DO NOT use wire brushes)
- Run a stiff wire bent into a small hook through each burner tube several times.
- Use compressed air to blow through the burner tube and out the burner ports. Check that air blows through each hole. (Wear eye protection)



STEP 04 Brush entire outer surface of burner to remove grime.



STEP 05 Clean any blocked ports with stiff wire such as an open paper clip.

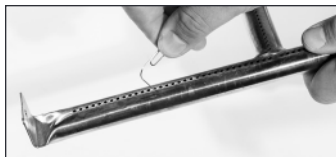

STEP 06 Carefully replace burners and reattach.

⚠ The gas rail fuel nozzle must be reengaged within the burner opening.

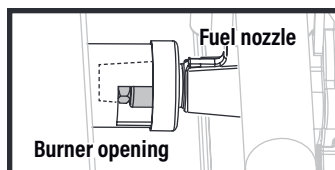

CUSTOMER SERVICE

Visit us online at blackstoneproducts.com/support for assistance concerning appliance use, replacement parts, or your warranty.

CUSTOMER SERVICE HOURS:



Monday - Friday
7:00 am - 5:00 pm (MST)

This page intentionally left blank



This page intentionally left blank



This product may be covered by one or more issued U.S. and/or international patents and may include patent applications pending. For more information, please visit: BlackstoneProducts.com/patents