

AVALON™

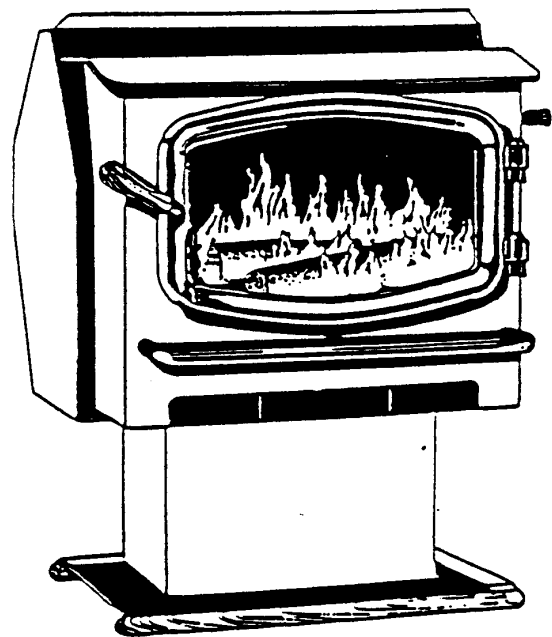
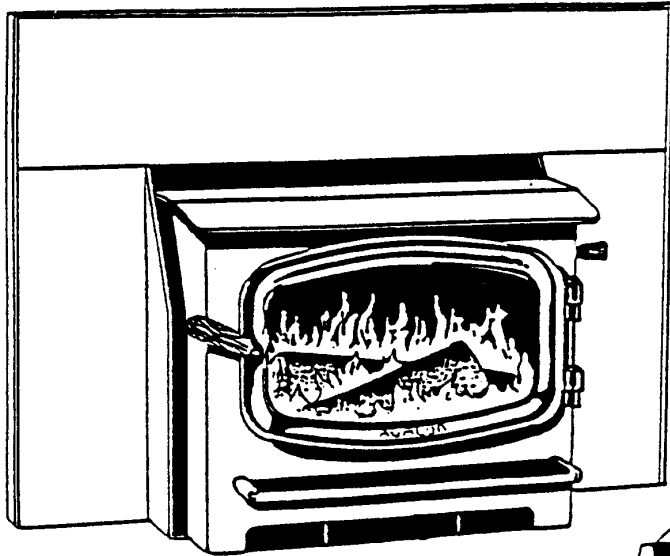

INSERT
FREESTANDING
ZERO CLEARANCE
MOBILE HOME
ALCOVE

Manufactured By: TRAVIS INDUSTRIES, INC.
10850 117TH PL N.E.
KIRKLAND, WA 98033

700 901 AND **1000 C2** ^(CATALYTIC)

CONGRATULATIONS . . . You've purchased an Avalon, the finest woodheating appliance available. Not only does it meet your needs today, but also your needs for the future. Your new Avalon Woodstove has passed all current emission standards including EPA's 1990.

The Avalon was designed with you in mind. A powerful, efficient heater with elegant appearance to satisfy your impeccable taste and heating demands.

We offer you not only our congratulations, but additionally our sincere thanks and our pledge to stand behind your new investment for years to come.

PLEASE make a note of your serial number, which is on the back of your stove, before beginning installation.

PLEASE read through the instruction manual before beginning installation.

SAVE THESE INSTRUCTIONS FOR FUTURE REFERENCE

GENERAL INFORMATION

Before installing your appliance, contact your local building authority for specific requirements concerning permits or inspections. Your AVALON dealer will assist you in obtaining these names and experienced professional help for your installation. AVALON recommends professional installation. It's quicker, easier and offers you peace of mind.

A NOTE ON SAFETY

When properly installed, certified AVALON heaters meet or exceed applicable safety standards and codes and is approved by an internationally recognized agency. Improperly installed appliances can lead to hazardous conditions. For you and your family's security, please follow the installation and operation instructions carefully.

TESTING

Your Avalon has been tested to U.L. 127, U.L. 1482, U.L. 907 and mobile home installation per (UM) 84-HUD. ICBO Report number TL130. All testing completed by OMNI Environmental, Beaverton Oregon. Report #SS-110-8 and #SS-110-11.

SAFETY PRECAUTIONS

DO NOT connect this appliance to any chimney or ducting serving another appliance or any AIR DISTRIBUTING DUCT.

Before installing your Avalon, check the clearance diagram on the last page of the instructions to make sure adequate spacing is available for unit and hearth protection.

WARNING

Do not make any changes or modifications to the stove or an existing masonry chimney or fireplace to install this appliance.

Do not use makeshift compromises.

Clearances to non-combustibles can only be reduced by means approved by the local authority.

Do not substitute components.

INSTALLATION INSTRUCTIONS:

ASSEMBLY REQUIREMENTS

Your Avalon comes completely assembled with these exceptions.

You will be required to place the firebrick lining within the stove on floor and sides. The masonry firebrick for your stove will be found in a box inside your appliance.

When preparing to install your stove, remove the contents of the unit, this will lighten the appliance and make it easier to move.

You will have to install the wooden knob on the air control (and by-pass damper on 1000C2). This should be done after the stove is completely installed as this will prevent breakage.

OPTIONAL PEDESTAL ASSEMBLY FOR FREESTANDING STOVE

Your Avalon freestanding stove is mounted to a pedestal boxed separately along with the solid oak dowling trim.

To attach the pedestal, lift your stove on to the pedestal base and line-up the bolt holes on the bottom of the unit with the two tabs located on the pedestal base. Bolt the stove firmly on to pedestal. When locating your stove onto the pedestal base, make sure it is centered so there is no danger of the unit tipping or falling. Alternate method is to turn the stove over on its back and bolt the pedestal on lying down.

Once you have placed your stove in the desired position you can tilt the stove to place the oak trim both back and front. Wait until stove is in position before installing trim to prevent damaging the wood.

NOTE: Put bricks in last. It is easier to install optional rear fan before securing stove to connector pipe.

INSTALLATION

Please read instructions completely and return your warranty card.

If you are going to use an existing masonry chimney for your appliance make sure the chimney is inspected and found in good and safe condition. If the existing chimney is not in good condition, repairs should be made before installation.

If you are going to use a factory built chimney it must be (6") in diameter and a type suitable for use with solid fuels. Follow the manufacturer's installation instructions packaged within the chimney appliance.

Wall, ceiling, or roof penetrations can only be made with U.L. or ULC listed chimney components. NOTE: Your interior single wall chimney must not pass through an attic, roof space, closet or similar unsealed space, floor, ceiling, wall or partition of combustible construction.

All sections of interior pipe connector should be securely fastened together by at least three sheet metal screws. Crimped end must be installed downwards.

Remember...your chimney should extend a minimum of three feet above your roof and at least two feet higher than any obstacle within ten feet of the chimney. Total minimum chimney height of twelve to fifteen feet is required. This is necessary to establish a proper draw.

Use 6" diameter...minimum 24 gauge connector with listed factory-built chimney suitable for use with solid fuels or lined masonry chimney. Chimney must be kept clean.

WARNING: Do not connect this unit to a chimney flue serving another appliance.
Do not use makeshift or compromises in the installation.

901/1000C2 FREESTANDING CLEARANCES

Be sure when you place your stove in position it meets all minimum clearances to combustibles.

REQUIRED CLEARANCES:

	<u>A</u>	<u>B</u>	<u>C</u>	<u>D</u>	<u>E</u>	<u>F</u>
1. Single wall pipe	16	20	18	17½	10	11
2. L Vent double-walled pipe for use in residential & mobile home applications.	8	20	10	9½	10	3
3. L Vent double-walled pipe (w/ side shields or flush unit) for mobile home or residential.	8	18	10	9½	8	3
4. Alcove (w/ side shields or flush unit) must use L-Vent double-walled pipe, alcove must be a minimum of 7' high and 45½" wide w/ 4' maximum depth, if combustible. Alcove may be 27½" minimum high, 36" minimum wide and 24" maximum depth if built of non-combustible materials and to UBC Chapter 37.	8	18	N/A	9½	8	N/A

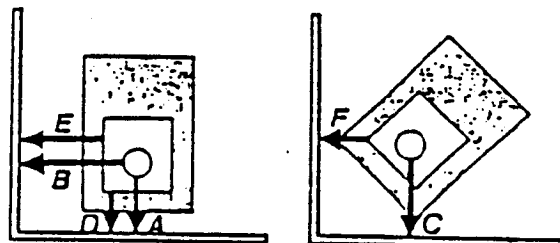

NOTE: See Page 4 for further explanation on alcove dimensions and installations.
HEARTH REQUIREMENTS:

Hearth pad must extend 8" back, 4½" sides and 16" from front of unit door.

AVALON

WOODSTOVES™
Mfg. by Travis Ind., Inc.

OPTIONAL LEG KIT FOR FREESTANDING STOVE

Your Avalon freestanding stove can be mounted on legs, the legs are boxed separately complete with attachment and leveling bolts.

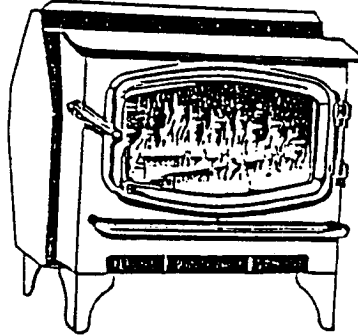

To attach the stove legs, remove the firebricks from the stove, close and lock the door. Roll the stove over on its back to rest on a piece of lumber approximately 2" thick or any piece of material so that the stove is raised and the paint finish is not damaged.

Position the legs on the bottom of the stove one at a time and screw the attachment bolt into the hole provided. Square the legs to the edges of the firebox and tighten the bolt using a 9/16" open end wrench.

Having secured all the legs, pull the stove over onto the legs. Using a 3/8" open end wrench adjust the leveling bolts to insure the unit does not rock when installed.

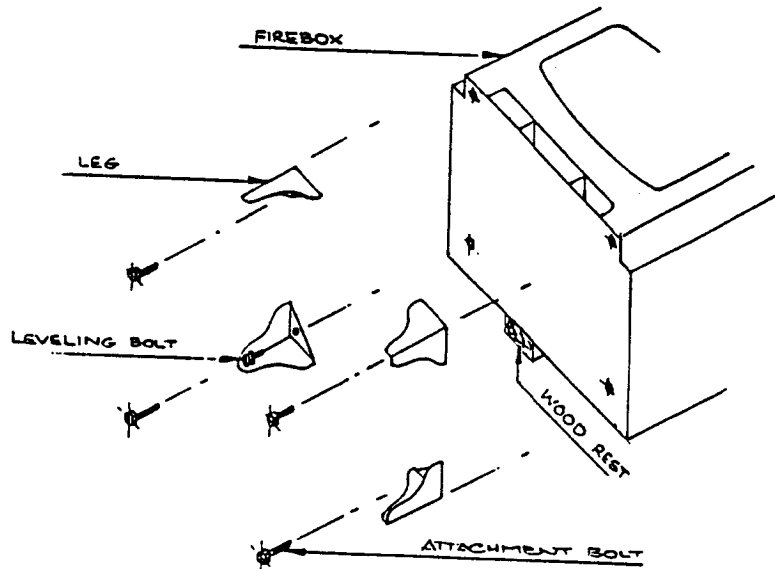

700 FREESTANDING CLEARANCES

	<u>A</u>	<u>B</u>	<u>C</u>	<u>D</u>	<u>E</u>	<u>F</u>
1. Single wall pipe	18	19½	18	21	11	13
2. L-Vent double-walled pipe for use in residential & mobile home applications.	10	19	17	13	11	11
3. Alcove (must use L-Vent double-walled pipe; alcove must be a minimum of 7' high and 46" wide with 4' maximum depth if combustible). Alcove may be 27½" minimum high, 36" minimum wide, & 24" maximum depth if built of non-combustible materials (and to UBC chapter 37).	10	19	n/a	13	11	n/a

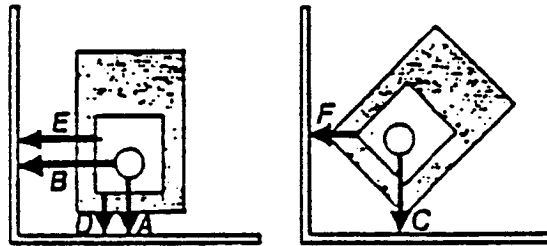

HEARTH REQUIREMENTS:

Hearth pad must extend 4" back & sides and 16" from front of unit.

MOBILE HOME INSTALLATION

All freestanding Avalons installed in a mobile home must use Security, Metalbestos, Jackes Evans or Dura-Vent double wall air insulated connector and chimney. You must use an outside air pedestal to bring in combustion air from outside the mobile home. Outside air pedestals are available through your Avalon dealer. Refer to clearances for your model of stove.

ALCOVE INSTALLATION

The 901/1000C2 flush freestanding stove or extended unit with side panels can be installed into an alcove. You must use six inch diameter L-Vent pipe with listed factory-built chimney suitable for use with solid fuels or a masonry chimney. Alcove size: minimum 7 feet high, minimum 45½" width, and maximum 48" depth. Refer to clearances for your model of stove.

The 700 stove can be installed into an alcove using 6" diameter L-Vent pipe with listed factory-built chimney suitable for use with solid fuels or a masonry chimney. Alcove size: 7 feet high, minimum 46" width and maximum 48" depth. Refer to clearances for your model of stove.

NOTE: The dimensions of non-combustibles alcoves (built to UBC Chapter 37) are 27½" minimum height, 36" minimum width and 24" maximum depth.

All clearances to combustibles from tests on the insert/freestanding are to be maintained. It should be understood that any legs, pedestals, shields or other alterations that increase the size of unit from the version tested in the "alcove" will increase the minimum "alcove" dimensions proportionately.

INSTALLATION WITH OUTSIDE AIR PEDESTAL ONLY

If outside air is required make sure you leave openings in appropriate position on hearth.

Pre plan position for outside air intake (see figure 2) making sure it doesn't interfere with structural members of home. For outside air you must cut a matching hole in hearth pad and floor of home. The base of the pedestal is 23" X 16". Find the center and cut 6" round hole in floor and hearth.

To prevent little critters from entering the house, a rodent screen is required to be installed over opening for outside air. (Fig. 2) A 6" tube with screen is provided with outside air pedestal.

Attach pedestal as directed on pg 2. Be sure to remove the forward knock out on bottom of stove body to allow outside air to enter unit.

To block out room air place insulation strips along both sides on pedestal bottom and place air dam in center under ashlip, also bolt down pedestal and ground stove with #8 copper wire.

VERTICAL INSTALLATION WITH FACTORY-BUILT CHIMNEY*

Check to see that no ceiling support members will be cut to install chimney and support box. (Fig. 2)

1. Reposition if necessary.
2. Mark position of flue center on ceiling.
3. Cut ceiling hole and frame in for support.
4. Cut remaining holes and install chimney and components.
5. Move stove aside, install floor protector, reposition, install connector.

Parts required for vertical installation and available from your dealer or professional installer are:

1. 6" chimney connector
2. Support box
3. Flashing for roof
4. Storm collar
5. Rain cap
6. Mastic for sealing roof flashing and storm collar

HORIZONTAL INSTALLATION (To outside of house)*

1. Reposition if necessary.
2. Mark position of flue center on wall.
3. Cut wall hole and frame in for support.
4. Cut remaining holes and install chimney and components.
5. Move stove aside, install floor protector, reposition, install connector, (See fig. 3).

Parts required for horizontal installation and available from your dealer or professional installer are: (Fig. 3)

1. 6" chimney connector
2. 90° elbow
3. Face plate and adjustable wall thimble (listed thru-the-wall chimney assembly)

Horizontal Installation cont....

4. Thru-the-wall tee
5. One tee support - outside chimney support
6. Weather shields and wall bands
7. Rain Cap

HORIZONTAL INSTALLATION (into existing masonry chimney) *

Parts required for horizontal installation and available from your dealer or professional installer are:

1. 6" chimney connector
2. 90 degree elbow (2-45's)
3. One face plate and adjustable wall thimble (trim collar)

* FOLLOW MANUFACTURER'S RECOMMENDATION FOR PIPE INSTALLATION, THESE ARE GUIDELINES ONLY

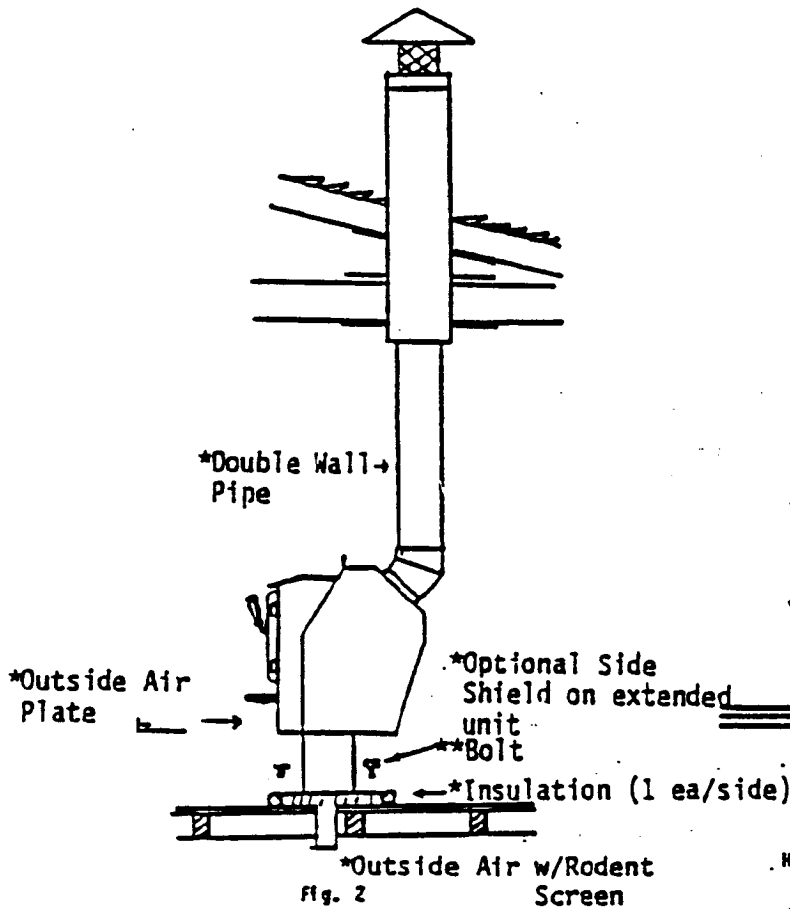

Fig. 2
VERTICAL INSTALLATION
WITH FACTORY BUILT CHIMNEY

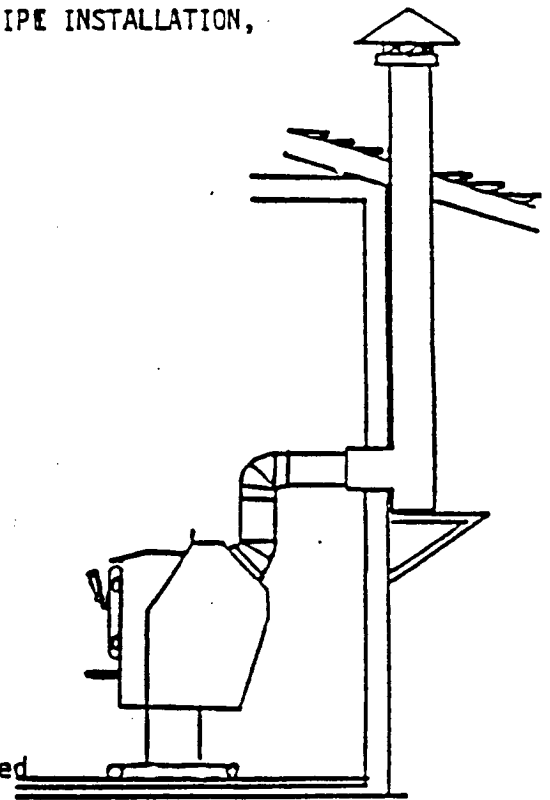

Fig. 3
HORIZONTAL INSTALLATION - to outside
of house.
(thru-the-wall assembly)

* Starred items are required for outside air or mobile home installations
 ** Unit must be bolted to floor pad for mobile home

AVALON

WOODSTOVES

AVALON PRODUCT UPDATE NO. _____
CONNECTION TO A METAL PREFABRICATED CHIMNEY
(Horizontal)

This method of installation requires at a minimum a wall pass through device, a wall support package and insulated "T" section and roof flashing.

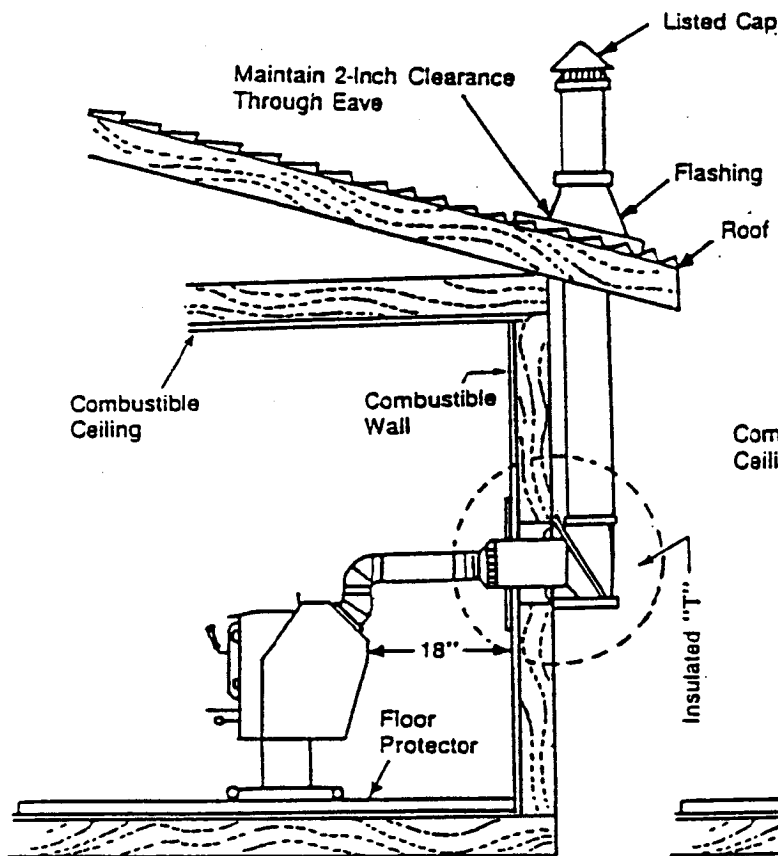
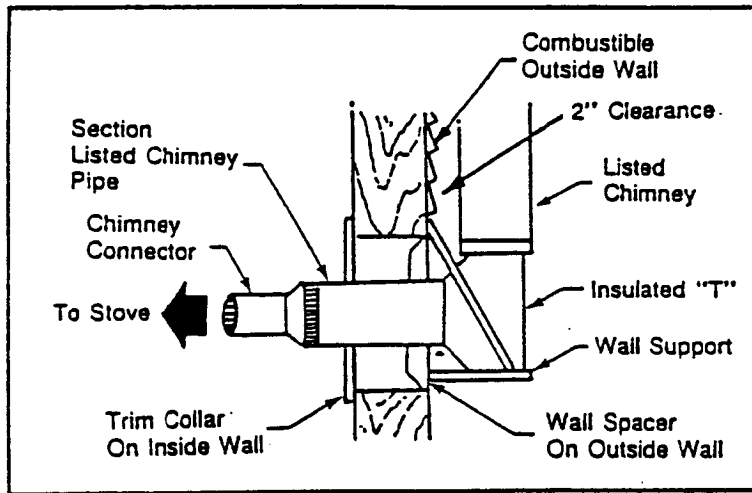

Option 1 - Use either 1 45° and 1 90° elbow or 3 45° elbows.

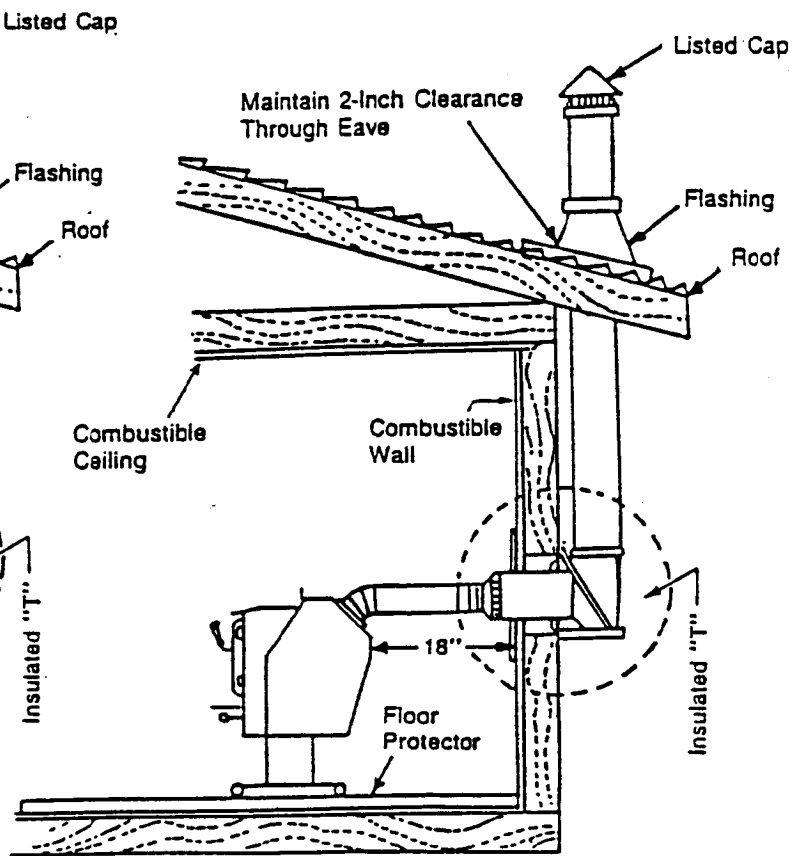

Option 2 - Use 1 45° elbow.

INSERT INSTALLATION

For your safety examine the masonry fireplace and chimney prior to installation of the fireplace accessory to determine that they are free from cracks, loose mortar, creosote deposits, blockages, or other signs of deterioration. If evidence of deterioration is noted the fireplace accessory should not be installed until after repairs have been made. Any opening between the masonry of the fireplace and the facing masonry must be permanently sealed.

Your Avalon is made for installation into masonry fireplaces. Avalon inserts may be installed with or without positive chimney connection. Positive connection is recommended for optimum stove performance. Large chimney openings will slow draft of stove.

See required clearances on the back page of this manual or pages 10 and 11 for your model.

LEVELING BOLTS

If your fireplace is stepped down from the hearth, you will be required to utilize the leveling bolts located within the hardware package.

These bolts screw into the weld nuts located on both sides of the firebox within the convection chamber. You will need to lean the unit back and install the leveling bolts through the bottom of the weld nut. Measure the distance that your fireplace floor drops from the hearth and adjust the leveling bolts to this height.

Remove all contents from the insert to lighten the weight. With the help of at least one other person lift the insert and place it about half way into the fireplace opening.

You may have to further adjust the leveling bolts at this time.

A. CONVENTIONAL INSTALL (NON-POSITIVE CONNECT)

1. Make sure fireplace and chimney are thoroughly cleaned.
2. Wire open or remove fireplace damper. (Figure 4, Page 9.)
3. Place stove on hearth and make sure surround panels are large enough to cover opening. 1½ - 2" overlap necessary to accommodate fiberglass seal. Fiberglass wool insulation strips are used to seal between insert surround panels and face of fireplace.
4. Drill two 11/64" holes each side and screw on side panels with screw provided. Then clip on top panel.
5. Position insert approximately 6" from face of fireplace and glue insulation to back of panels to match fireplace opening.

NOTE: Adhesive to secure insulation to panels is available from your dealer.

6. If you purchased optional brass trim refer to page 8 before proceeding. Push insert in until seal is made against face of fireplace. Be careful not to scratch your hearth.
7. Make sure insert is square in the fireplace opening. Use a screwdriver to tuck any exposed insulation behind the panels. Check for a good seal by running a match around perimeter of facing panel to determine if any drafts are occurring. If so, fill the spot with more insulation and recheck.

INSTALLATION OF "OPTIONAL" BRASS TRIM

1. Place trim face down on floor as it would appear on the insert.
2. Place corner brackets in appropriate slots.
3. Once in place, insert set screws and firmly secure.
4. Slide completed trim over panels. You may wish to add two sided tape at the ends of the trim to hold it firmly against the bottom of the side panels.

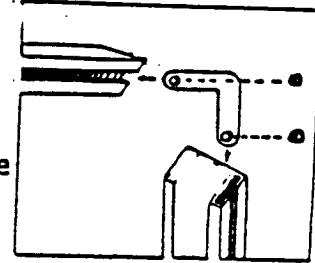
B. POSITIVE CHIMNEY CONNECTION

1. Measure below damper area the width from side to side at rear of smoke chamber. (Figure 4)
2. Measure below damper area the width from side to side at front of smoke chamber.
3. Measure below damper front to back of smoke chamber.

Results should look similar to Figure 5 on Page 9.

Transfer these measurements to a piece of sheet metal (min. 24 gauge) large enough to accommodate your size. Then add 2" to perimeter and bend to 45°. (This extra 2" lip will allow you to screw this plate into the smoke chamber.)

4. Position 6" hole to line up with chimney opening and cut hole.
5. Wire open damper.
6. Put plate in position, drill and lag in masonry with several screws. (Seal may be made using fiberglass insulation between masonry and metal.) (Figure 6)
7. Once plate is in position slide pipe into plate up through damper.
8. You may now place your new appliance into the fireplace opening and position the connector pipe so it can easily be pushed into the flue opening on top of the insert. (Figure 6)
9. Once this has been accomplished you can reach in and pull the connector pipe down into the flue of the insert. (NOTE: If ample room between the inserts top and the fireplace opening does not exist to pull the connector down, you may reach inside the stove and pull the connector down to the insert by placing your hand up through the flue opening of the stove.)

Follow insert installation instructions "A" numbers 3 through 7.

Follow installation instructions in reverse order for periodic inspection and cleaning.

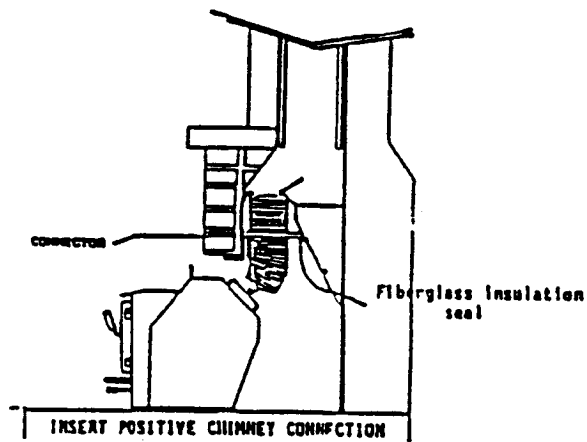
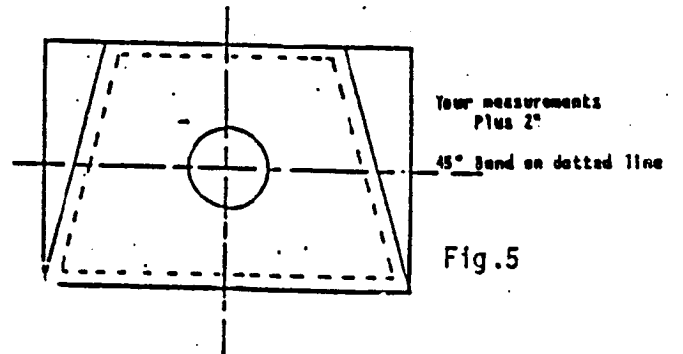
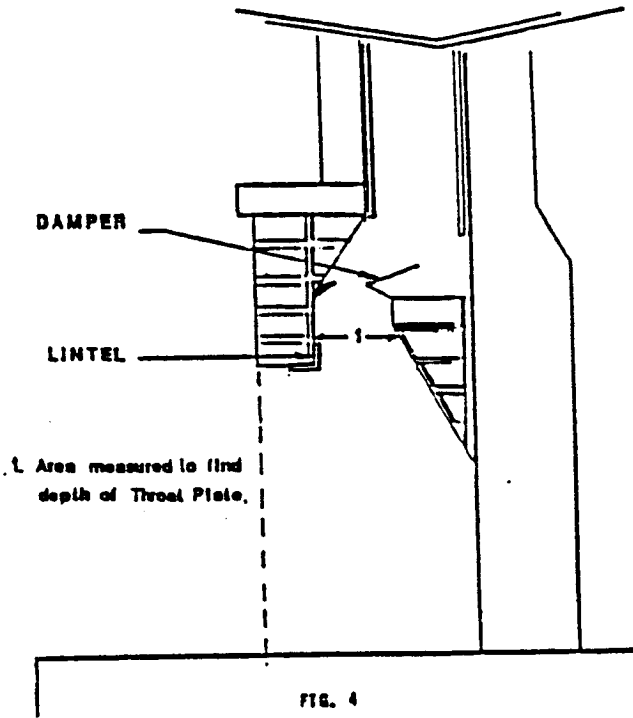

ZERO CLEARANCE INSTALLATION

1. The chimney must be lined with a Listed U.L. 103 or U.L. 1777 High temperature chimney reliner of stainless steel construction.
2. The chimney must be centered and supported at the top of the chimney as shown in figure 22.
3. The liner must be centered and wrapped at the bottom as shown in figure 22 to prevent thermo-syphoning around the chimney liner which can cause creosote build-up in the chimney and excessive heat loss.
4. The weight of the liner should also be supported by the stove or the fireplace firebox floor.
5. For offsets in the chimney flexible liner should be used. The flexible liner must be centered with ceramic wool blanket, protected by an expanded metal (screen) wrap. See Figure 22.

INSTALLING STOVE AND LINER

1. Remove the chimney cap by drilling out the rivets or removing the screws.
2. The chimney should be cleaned and inspected before installing your system.
3. Locate any offsets to determine the location of flexible sections (see guidelines).
4. Install your liner as per guidelines preceding.
5. Determine any modification necessary to install the stove in the firebox. The following are acceptable modifications.
 - A. Smoke baffles hanging down from the fireplace opening may be removed.
 - B. Curtain mechanisms may also be removed from the top of the fireplace opening.
 - C. Masonry firebox linings may also be removed if necessary.
 - D. Smoke baffles inside the firebox may also be removed.
 - E. The damper will have to be removed before the liner can be installed.No modifications may be made to the fireplace that will compromise its structural integrity, also no modifications or restrictions to convection or cooling air system of the fireplace.
6. Install the stove in the firebox. In some cases supporting the front of the unit may be necessary. There are several methods of supporting the unit such as decorative legs, screening or adjustable legs. Ask your dealer for further details.
7. Be sure to check the clearance page on the last page of the manual.
8. You can now mount the surround panel (on inserts).

901 AND 1000C2 INSERT/HEARTH CLEARANCES INTO MASONRY FIREPLACE

A	Mantle	27"
B	Top Facing	19"
C	Sidewall	11"
D	Side Facing	9"

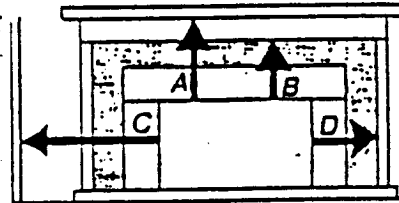

HEARTH REQUIREMENTS:

Hearth pad must extend 4½" to sides and 16" from front of unit.

700 INSERT/HEARTH CLEARANCES INTO MASONRY FIREPLACE

A	Mantle	28"
B	Top Facing	28"
C	Sidewall	14"
D	Side Facing	10"

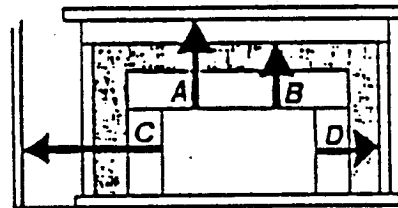

HEARTH REQUIREMENTS:

Hearth pad must extend 4" to sides and 16" from front of unit.

700/901/1000C2 INSERT INTO ZERO CLEARANCE FIREPLACE

All Avalons as inserts can be installed into the factory built fireplaces listed on page 11. You must vent into a chimney relined with approved U.L. 103 H.T. or equivalent U.L. 1777 chimney reliner. Surround panels are optional.

The 700, 901 and 1000C2 can be used with all other listed factory built fireplaces as long as no surround panels are used AND the appliance is vented into a relined U.L. 103 H.T. Chimney.

NOTICE: When installing this improved woodburning system changes must be made to your present one. The new system should not be removed. Zero clearance Fireplace Warranty voided by these changes!

We strongly recommend installation by qualified licensed professionals and inspection by your local building inspector.

Drill out rivet or spot welds and replace with screws.

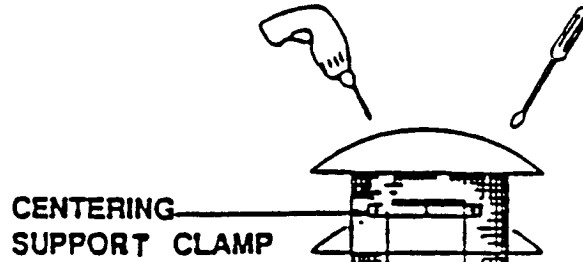

ZERO CLEARANCE INSTALLATION:

OFFSETS use flexible liner (stainless steel) center and seal with ceramic wool covered with expanded metal.

STAINLESS STEEL LINER

Center and seal with Ceramic wool

45° St. Stl. Elbow or flex.

16

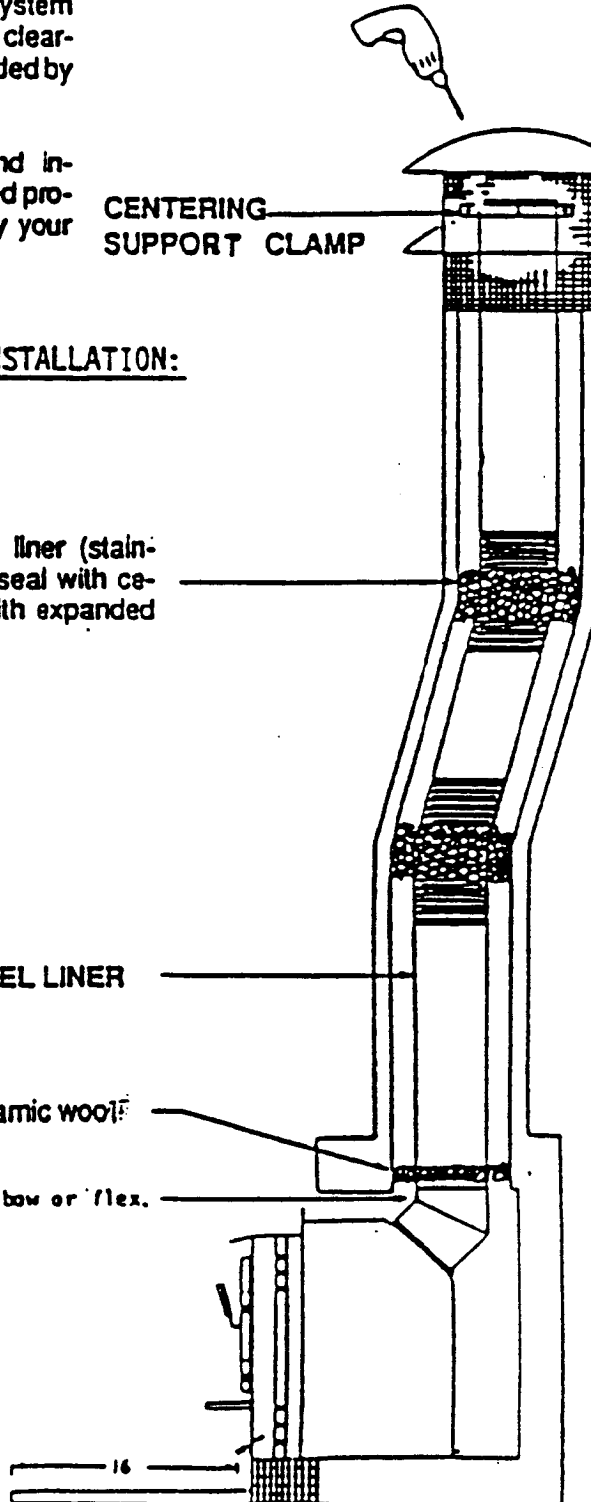

ZERO CLEARANCE FIREPLACES APPROVED WITH OR WITHOUT INSERT PANELS

Majestic Models	M-36, MBC-36, MBC-36M, MD36R, MD-36-AO, L-36B, M-42, L-42, MBC-42, MBC-42F, MD-42, MD-42AO
Marco	DF-36B, DWF-36P, DWF-36D, DWF-36GO, DWF-36F-2, SWF-36G-2, DWF-36P-2, DF-41D, DF-41F, DF-41GO, DF-42
Heatilator	BF-36, CR-36A, FP-36, FP-36C, RF-36, BH-42, 3138, 3036, 3042
Temtex Industries	TBF-36-1, TBF-36-2RS, TBF-42-1
Preway	BE-41, BI 41, BI 42
Superior	CF-38G, CF-3860, FR-3860

700 FIREBRICK ASSEMBLY

Your new stove utilizes a firebrick liner to increase the even distribution of heat output and to increase heating capacity on low or medium rates. This firebrick liner will also increase your stove's life considerably over a non-lined appliance.

To place the firebrick liner in your stove follow the numerical order of the diagram in Figure A.

NOTE: Brick #4 and #8 have been cut to 4 1/2". Cut brick is designated with black paint.

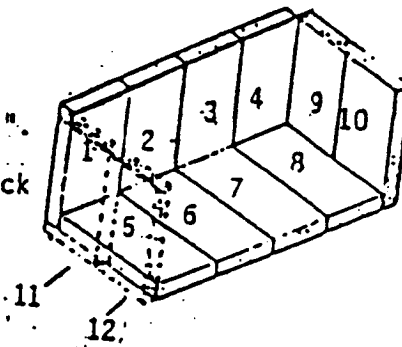

FIG. A

700 FIREBRICK BAFFLE ASSEMBLY

Part of your stove's computer modeled combustion system is the steel and firebrick baffle.

This baffle not only holds valuable heat within the unit, it also retains the heat and helps ignite gases and particles passing over it before they can leave the appliance. This is commonly called secondary combustion and makes the appliance burn cleaner and more efficiently.

700 FIREBRICK BAFFLE ASSEMBLY (Continued)

Follow the diagram in numerical order to place the firebrick into the stove's baffle plate. (Figure B)

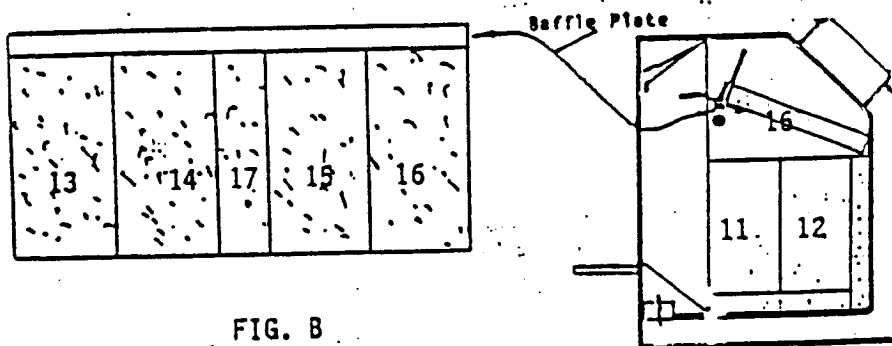

FIG. B

Brick #17 is 2-1/8" X 9" as opposed to the balance of the bricks, which are 4-1/2" X 9".

901 FIREBRICK ASSEMBLY

Your new stove utilizes a firebrick liner to increase the even distribution of heat output and to increase heating capacity on low or medium rates. This firebrick lines will also increase your stove's life considerably over a non-lined appliance.

To place the firebrick liner in your stove follow the numerical order of the diagram in Figure A. Please be certain floor brick butts up against back wall of firebox and is centered in stove. (Back wall brick sits on floor brick.)

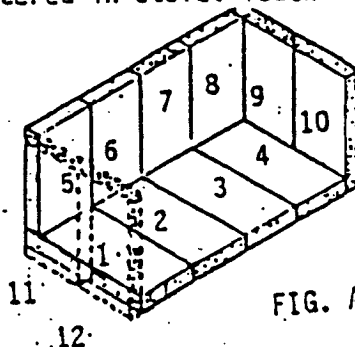

FIG. A

Be certain sidewall brick #'s 9, 10, 11 and 12 lean at an angle (bottom of brick touch floor brick and top of brick leans into sidewall of stove firebox.) This angle enhances combustion airflow and efficiency of the stove.

901 FIREBRICK BAFFLE ASSEMBLY

Part of your stove's computer modeled combustion system is the steel and firebrick baffle.

This baffle not only holds valuable heat within the unit, it also retains the heat and helps ignite gases and particles passing over it before they can leave the appliance. This is commonly called secondary combustion and makes the appliance burn cleaner and more efficiently.

Follow the diagram in numerical order to place the firebrick into the stove's baffle plate. (Figure B)

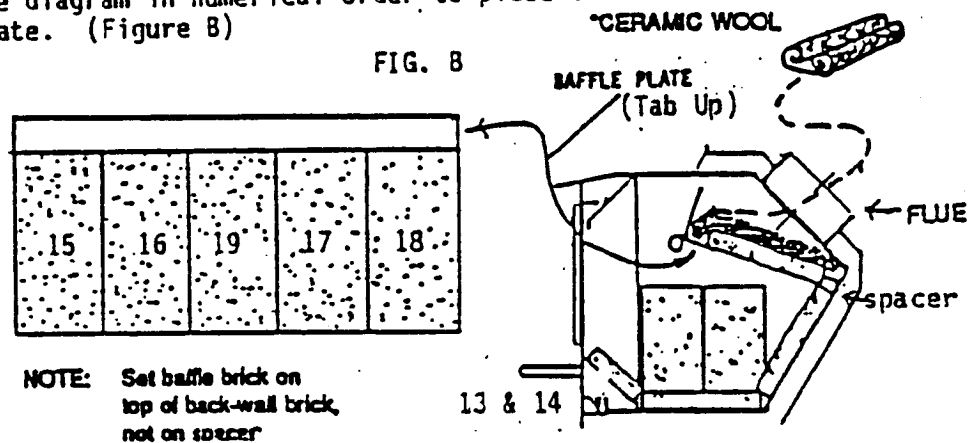

NOTE: Set baffle brick on top of back-wall brick, not on spacer

NOTE: Brick #19 has been cut to 4 1/2". Cut brick is designated with black paint.

* Roll ceramic wool blanket in from both ends as shown. Insert through flue pipe as shown. Unroll towards either side of stove, be sure it is fully unrolled and lying flat on bricks. Tuck the front edge of the blanket into the gap between the baffle plate and bricks as shown. Push baffle plate toward stove back.

1000 FIREBRICK ASSEMBLY

Your new Avalon 1000 utilizes a firebrick liner to increase the even distribution of heat output and to increase heating capacity on low or medium rates. This firebrick liner will also increase your stoves life considerably over a non-lined appliance.

To place the firebrick liner in your stove follow the numerical order in the diagram in Figure 9.

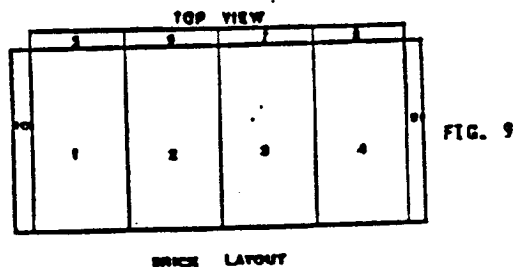

WOOD HANDLES

Your final step is to install the wood handle on your draft control. If you purchased a 1000C2 you will also need to install wood handle for the by-pass damper control.

OPTIONAL FAN INSTALLATION--Front Fan/Insert or Pedestal--

1. Screw the adjusting screw out until it is engaged in the adjustable clip by approximately 2 threads.
2. Hold the fan approximately 45° to the stove body engaging the fixed clip on the left in the air chamber first.
3. Engage the left hand "U" clip onto the air chamber extension plate.
4. Engage the right hand "U" clip onto the air chamber extension keeping pressure on the fan housing to the left side of the stove.
5. Screw the adjusting screw in a clockwise direction until it is tight.

--Operation--

Simply turn knob on rheostat control to the right, this is the highest speed. Fan speed will decrease as you continue turning the knob to the right. Reversing operation will increase fan speed, completely to the left will turn fan off.

--Rear Fan/Pedestal Only--

1. Remove the 6" X 4" knockout on the bottom, rear of the stove body. (This is the opening to the convection chamber.)
2. Place the right side of the fan bracket up inside the knockout first. Move to the right until the left can be inserted.
3. Center the fan evenly and attach screws.
4. If air chamber does not have mounting holes, two $\frac{1}{2}$ " holes will have to be drilled on each side of the knockout. With fan in place mark and drill holes.
5. Remove plug from right side of pedestal.
6. If pedestal does not have rheostat hole, measure down 5" from stove body and 4" in from back of pedestal. Mark and drill 25/64" hole.
7. Push rheostat through hole and attach with self-tapping screw. Do not overtighten as stripping may occur.

--Operation--

Simply turn knob on rheostat control to the right, this is the highest speed. Fan speed will decrease as you continue turning the knob to the right. Reversing operation will increase fan speed. Turn control completely to left to turn off.

OPERATION

Please follow the instructions given in this section carefully.

To build a fire in disregard of the information provided in this section can cause permanent damage to your appliance and void your warranty.

This unit is not designed for use with the door open. Burning with the feed door open could create a safety hazard.

BURNING PROCEDURE - ALL STOVES

1. Open door and place paper and small kindling inside unit.
2. ~~1000C2-ONLY~~ Before lighting unit, make sure the by-pass damper rod is in the full open position. Do this by pulling the damper up and then left to rest on the metal stop. After the fire is established, close this down by pushing right and down. During normal operating conditions, keep the by-pass closed.
3. Make sure that the combustion air in-take control (located on the lower right hand side is fully open). Do this by pushing the control knob all the way up.
4. Now, light the fire. Once the kindling is burning, add some small dry pieces of wood and close the loading door. NOTE: The first two or three fires in your new appliance will cause the high temperature paint to give off a slight odor and a small amount of smoke. For best results during the curing of the paint, burn small intense fires so the unit does not overheat. The high temperature paint cures best at medium temperatures. Also, the viewing glass may become somewhat obscure the first few times, as your unit is drying all moisture from bricks and even the steel itself.
5. Next add two or three medium size dry logs (use of green or wet wood in your stove will develop creosote, cloud glass and greatly decrease its efficiency. At this time establish a hot fire with a bed of red hot coals. ~~1000C2 (ONLY)~~ Once hot fire is established close the by-pass control (down position).
6. To slow the rate of burn, you can close (push down) the combustion air intake control (lower right side) as needed.

NOTE: Over restricting the amount of combustion air into the stove will cause creosote buildup on glass and in the stove and flue. This will also greatly decrease the efficiency of the stove.

Do not open door of your unit when the air control inlet is fully closed. There is a possibility with any solid fuel burning appliance doing so could result in a sudden flash of flames as the fire re-ignites with oxygen. However, all Avalons have been thoroughly safety tested to reduce this possibility.

(Also, do not open loading door when your stove's flue damper is closed. This will result in smoke and soot being forced into your home. Damper on 1000C2 only.)

BURNING PROCEDURE (Continued)

If your home is a new, air tight energy efficient home, you may have to supply an outside air inlet to prevent possible air starvation to appliance.

DAILY USE OF YOUR STOVE

During daily use of your stove you will learn what levels of burn best take care of your heating needs. Purchase of a stove thermometer is highly recommended. Approximate low burn 300°, approximate medium burn 600° and approximate high burn of 800°F.

Some helpful hints: After loading your stove open the air control and allow your stove to burn vigorously for 20 or 30 minutes. This will insure the burn-off of any creosote which accumulates over periods of extended use at low-settings.

SAFETY IN OPERATION

1. Do not use this appliance for any purpose other than heating. Burn solid wood fuels only.
2. "Never use gasoline, gasoline-type lantern fuel, Kerosene, naphtha, engine oil, charcoal lighter fluid, or similar liquids to start or "freshen up" a fire. Keep all such liquids well away from the fireplace accessory while it is in use."
3. Do not burn garbage in your stove, or use chemicals or fluids to start the fire.
4. Use caution when loading fuel into stove after it is already burning vigorously.
5. Do not overfire stove at any time. If stove glows red it is overfired.
6. Keep all household combustibles and stove fuel at least 3 feet from stove at all times. Store fuel in a dry place well away from the heater.
7. Do not support or elevate fire off of firebrick. Burn fire directly on bricks. Do not use a grate.
8. Educate your children with the dangers associated with fire and the presence of hot appliances. Touching a radiating surface can cause serious burns. Child guards are available through your dealer.
9. Keep loading door closed at all times except to load fuel.
10. Avoid placing logs and fire against viewing glass.
11. Maintain the door and glass seal and keep them in good condition.
12. Do not modify your combustion air control to allow more air into your unit.
13. Do not burn any kind of coal in this unit.
14. Do not slam door or strike glass.

OPERATION OF 1000CZ WITH CATALYTIC COMBUSTORS

What is a catalytic combustor?

A catalytic combustor is an element, which, when inserted properly into a wood burning device will "burn" the smoke, carbon monoxide and particulate which is not burned by the fire. Think of it as an "after burner" which, because of a "catalyst", chemically breaks down smoke, carbon monoxide, and particulate into substances that are burned at a low temperature.

The most important thing to remember when operating a catalytic combustor equipped device is to make sure you have achieved catalytic "light-off" before you place the unit into the catalytic operational mode. Light-off simply means that you have achieved enough temperature within your unit to start the catalytic combustor operating. Catalytic burning, like all types of burning, requires three essential elements: fuel, oxygen, and temperature. The "smoke" is the fuel. Your unit has been designed so that it will have sufficient oxygen, but you must assure that you have the required temperature. The temperature needed to begin catalytic activity is generally 500 degrees F. internally, your stove top on the outside surface will usually be 250° - 300°. This is a temperature that is easily achieved when you build a fresh fire or when you reload your existing fire. The use of a magnetic thermometer, a probe thermometer or various digital readouts available on the market today will be of tremendous help to you in determining if you have achieved the necessary temperature.

Your unit is also equipped with a by-pass mechanism which allows you to "by-pass" the smoke around the combustor when you do not have the necessary 500 degrees to start the catalytic activity or when you are reloading your stove.

The proper use of your by-pass mechanism and temperature gauge are the two most important things to learn when operating a catalytic combustor equipped device and if used properly, will eliminate a large portion of combustor problems.

The other single most important thing to remember when operating a catalytic combustor equipped device (or any wood burning device), is to burn seasoned, dry wood only and not to use your wood-burning device as a "garbage incinerator". If you remember your high school science, you will remember that a "catalyst" is an element which will cause something to happen under conditions by which they would not normally happen, without being consumed, or used up by that reaction. In a wood-burning device, this simply means that the catalyst is allowing the smoke to be burned at 500 degrees rather than the normal 1100 to 1200 degrees that it would take to burn all the elements in smoke. There are elements in "garbage" (i.e. other than dried, seasoned wood) that the catalyst will not react with. Some of these elements are lead, sulfur, etc., and as they come in contact with the catalyst they stick to it, covering it up, so that the elements in wood smoke such as hydrocarbons, particulate, and carbon monoxide cannot contact the catalyst and are not burned. This process is referred to as "poisoning" and, after a period of time, the catalyst is covered and your catalytic combustor will no longer work. How long this process will take to completely cover all the catalyst depends on you and what you burn in your stove.

OPERATION - CATALYTIC 1000C2 ONLY

Unlike other combustors on the market, your Technical Glass HONEYCOMB will not show signs of catalyst peeling or substrate crumbling because of our superior ceramic and catalyzing process. You may occasionally see a crack develop on the face of the combustor but this will not interfere with the performance of the combustor and is not cause for concern.

Occasionally problems may develop with your catalytic stove that are not caused by the combustor but can usually be repaired by stove maintenance or installation revisions. Examples of stove maintenance problems are warpage of the by-pass mechanism, allowing smoke to escape without going through the combustor and warpage of the combustor mounting system causing the combustor to slip or fall or allowing smoke to go around the combustor rather than through it.

Other problems such as backpuffing, condensation in the chimney, poor draft, etc., are usually related to stove and chimney installation.

Occasionally new burning procedures or loading techniques may alleviate the problem. Proper stove maintenance is essential and your owners manual outlines the proper procedures you will need.

To maintain optimum performance, some normal maintenance is required. It is recommended to clean the catalyst by vacuuming or blowing-out fly-ash several times during the burning season (minimum of twice a year).

Finally, it is important to remember that the catalytic combustor is an "after-burner" and will be most beneficial to you when you are operating your stove to obtain a long steady burn and heat output. It is in this type of operation that your stove is smoldering the fire and creating substantial amounts of smoke or fuel for the combustor.

CATALYTIC WARRANTY FOR 1000C2 (There are two catalytics in stove)

Technical Glass Products warrants to the consumer to replace at NO CHARGE any Technical Glass Products catalytic HONEYCOMB which ceases to maintain 70% of its particulate emission reduction activity (as measured by a approved testing procedure) within two years from the date of purchase by said consumer provided the following conditions are met:

1. The consumer calls Technical Glass Products at 1-800-426-0279 or 1-206-624-3890 to obtain a replacement authorization number.
2. The consumer must provide the brand name and model name\number of the wood burning device along with date and place of purchase.
3. The catalytic HONEYCOMB was not abused in any mechanical way.
4. The consumer burned only wood in the device as per the manufacturer's operation manual.
5. The original Technical Glass Products catalytic HONEYCOMB along with Item #2 and this warranty card are returned to Technical Glass Products, 5525 Lake View Drive, Kirkland, WA 98033.

If after two years the Technical Glass Products catalytic HONEYCOMB ceases to function, an additional pro-rated warranty will apply, enabling te consumer to replace their HONEYCOMB at the following special price

CATALYTIC WARRANTY FOR 1000C2 (Continued)

This pro-rated warranty is available thru Technical Glass Products only and the conditions as outlined in Items #105 apply.

Technical Glass Products' obligation under this warranty is limited to providing one free or pro-rated catalytic HONEYCOMB for each defective Honeycomb returned by the consumer; and under no circumstances will Technical Glass Products be responsible for servicing, removal, installation, or any other such costs. This warranty is Technical Glass Products' exclusive warranty and Technical Glass Products disclaims any other express or implied warranty for the catalytic HONEYCOMB including any warranty of merchantability of fitness for a particular purpose.

RESOLUTION GUIDELINE

PROBLEM: Creosote accumulation or dirty smoke from the chimney

CAUSE:

1. You are not getting "light-off" in the combustor.
2. You are burning wet wood or improper fuels.
3. Your by-pass mechanism is not fully closing; allowing smoke to go around the combustor rather than thru the combustor.
4. Your combustor is not functioning and needs to be replaced.

SOLUTION:

1. Make sure you have achieved 500 degrees F. internally (necessary for "light-off") before engaging the combustor, 250°-300° externally on stove top.
2. Burn only dry seasoned wood.
3. When the stove is not burning, make sure that the by-pass mechanism is closing fully and that there are no obstructions. Read units operating manual for proper maintenance.
4. Replace your catalytic combustor.

PROBLEM: Plugged combustor

CAUSE:

1. You did not achieve "light-off" temperature prior to closing your by-pass mechanism and engaging your combustor.
2. You are burning materials which are coating the catalyst, such as heavy papers, wet wood, garbage etc.
3. Your catalytic combustor is no longer functioning and needs to be replaced.

SOLUTION:

1. Make sure you have at least 500 degrees F. (necessary for "light-off") before engaging the combustor, 250°-300° externally on stove top.
2. Burn only dry seasoned wood.
3. Lightly brush the face of the combustor with a soft bristle brush such as a paint brush to remove the accumulation.
4. Build a hot fire in your stove, engage the combustor half-way, then two-thirds, then fully to "burn" the accumulation of materials off the combustor.
5. Replace your catalytic combustor.

PROBLEM: How do I know if my catalytic combustor is working?

SOLUTION: Ask yourself the following questions. If your answers are YES, your catalytic combustor is working properly.

1. Am I burning less wood to get the same amount of heat?

RESOLUTION GUIDELINE (Continued)

2. Does my combustor glow red for a short amount of time (approx. 1½ hours) during my wood load? (The combustors are visible through the viewing glass in the upper portion of the firebox.)
3. Is there substantially less creosote in my chimney?
4. Is the smoke exiting my chimney white in color and usually odorless?
5. Does a visual inspection of the combustor show it to be clean of any fly ash, creosote or soot?

If the answers to any of the above questions are "NO" the solutions outlined previously may help you to activate your combustor again.

OPERATION--Thermometer--

Purchasing a stove thermometer is highly recommended for monitoring the stove temperature. The thermometer should be located on the firebox top. (See example)

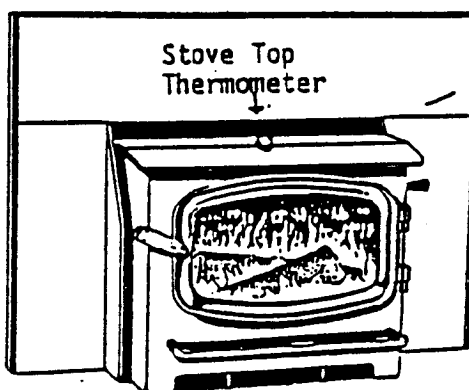

Top
Center.

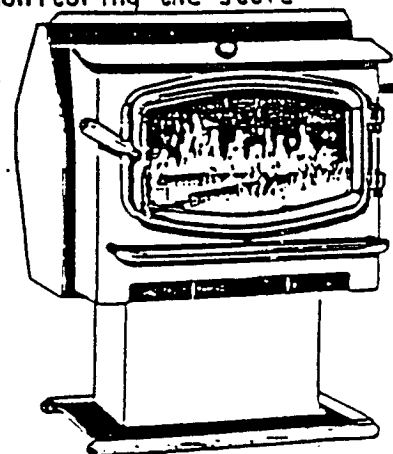
--Stove Top Temperatures--

Approximate burning temperatures for a Low Burn Mode (overnight burn) is 200-400 degrees Farenheit. Medium Burn Mode is 400-600 degrees Farenheit and High Burn Mode is 600-800 degrees Farenheit. It is recommended that the stove be burned very hot (800 degrees F) for approximately 30 minutes in order to burn the creosote out of the firebox, flue and off the glass after low burn or over-night. The burn mode recommended for normal operation, achieving a high-efficiency level and low pollutant level, is medium-high.

It will take a few weeks to become familiar with what settings achieve the desired burning temperatures. There is no set position on the draft control as each installation and wood type varies.

--Seasoning the Paint--

For the first few days the stove, and pipe if freestanding will give off an odor and a small amount of smoke. This is to be expected as the high temperature paint becomes seasoned to the metal. Do not burn the stove over a medium burn for the first few days to allow the seasoning to take place; high temperatures will damage the paint. During the first few days allow adequate ventilation for smoke and odor.

Wood--

Choosing the kind of firewood to burn in your stove depends on what is available to you. If all you can obtain is softwoods, obviously, that will be your choice.

Softwoods such as pine and fir are easily ignited and burn rapidly with hot flames. Since they burn so easily and quickly you will have to spend more time loading your firebox, especially in the high burn mode. With softwoods it will be much more difficult to achieve an overnight burn.

If you do have a choice it is best to use the more dense hardwoods for a longer lasting fire. Also, it is a good idea once the fire is established to use larger diameter logs stacked tightly together. This will promote a longer burn time.

The ultimate arrangement would be to have a mix of softwoods and hardwoods. This way you could use the softwood for ease in startup and the hardwood for longer burn times.

Wood is typically sold by the "cord". A cord is a nicely stacked pile of logs measuring, 4 feet by 4 feet by 8 feet. Always look for the driest wood especially if you purchase your wood by weight. Unseasoned, wet wood is much heavier.

Use Dry, Seasoned Wood--

Moisture content of the wood greatly affects the way any stove operates. Well seasoned wood (split, stacked and kept dry for at least 12 months) is your best fuel choice.

Wet wood not only causes more work for you due to the increase in weight making it more burdensome to carry, but most importantly it will not burn as efficiently. You will receive less heat output from a wet piece of wood because it takes energy to evaporate the water, energy that should be used for heating your home. When a wet piece of wood is placed in your stove it will also cause more creosote deposit on the glass in the stove, flue and chimney. The primary reason for this is as the water evaporates from the wood it will "spit" creosote-like material. If you can hear your wood sizzle or you can see moisture bubbling from the ends of the logs placed in a HOT stove, your wood is too wet!!!!

Another big advantage to burning seasoned wood, aside from higher efficiency and less creosote, **LESS POLLUTION!**

Your wood should be stored in a well sheltered, ventilated area to allow proper drying during the year to come. This is necessary even if you've purchased seasoned wood.

Creosote--

Creosote is a tarry liquid or solid resulting from the distilling of wood during the combustion system. Using wet wood or burning at lower temperatures will result in a heavier creosote deposit forming. Creosote vapors will condense in a relatively cool chimney flue of a slow burning fire. As a result, creosote residue accumulates on the interior surface of the chimney and flue pipes, considerably reducing their diameter. When ignited, this creosote makes an extremely hot and dangerous fire. The chimney should be inspected at least once every 2 months during the heating season to determine if a creosote build-up of approximately 1/4" has accumulated. If this is the case, the creosote should be removed to reduce the risk of a chimney fire.

Most problems with creosote are due to poor chimneys with low draft and /or cold walls, and to a low rate of burning when little heat is needed during the spring and fall months. Burning green and resinous wood also creates creosote.

Ways to Prevent and Keep Unit Free of Creosote-

1. Burn your stove with draft and damper controls wide open for about 35-45 minutes daily during the burning season (800 F.). This will burn out creosote deposits within your stove. (Damper on 1000C2 only).
2. Burn the stove with draft and damper controls wide open for about 20 min. every time you apply fresh wood. This allows wood to achieve the charcoal stage faster and burn wood vapors which might otherwise be deposited within the system.
3. Burn only seasoned wood. Avoid burning wet or green wood. Seasoned wood has been dried at least one year.
4. A small more intense fire is preferable to a large smoldering one that will deposit creosote within the system.
5. Establish a routine for using your new stove. Check daily for creosote build-up until experience shows how often you need to clean it to be safe. Be aware that the hotter the fire, the less creosote is deposited on the glass and chimney system. Weekly inspection and cleaning may be necessary during times of heavy stove use. Contact your local fire authority for information on how to handle a chimney fire. Have a clearly understood plan to handle such a fire.
6. Have your chimney system and unit cleaned by a competent chimney sweep twice a year during your first burning season, and at least once a year thereafter.

Burning Your Stove Efficiently—

Your Avalon is designed to heat your home efficiently with the lowest amount of creosote build-up and pollutants being emitted. The following is a guideline to efficient burning...

On cold days, when you wish for high heat output from your stove, load the stove fully after the fire has been established and burn at a medium-high to high mode. When a comfortable heat level in your home has been reached, subsequent loadings should be of lesser amounts of wood. On warmer days, burn smaller fires (using less wood). This method will give you the most efficient burn possible.

Although the fire will burn longer at a lower setting your stove will not produce as much heat and it will leave the stove, chimney and glass sooted along with emitting a larger amount of pollutants into the environment.

For an overnight burn establish a hot fire. Before you are ready to retire completely fill the stove with wood. With the controls in the fully open position let the fire burn intensely for 20-30 minutes. Next, (close the damper on 1000C2 and) adjust the draft control so that a low, lazy flame is visible. In the overnight burn you should be able to maintain a fire about 6-9 hours (depending on wood type and stove size used) and have a coal bed, no visible flame, left to start the morning fire. After an overnight burn, to re-establish a fire, open the controls fully and stir the ashes to bring the hot coals to the surface. Then, follow instructions under "first fire". If you dampen the fire down too low you will not only lower the heat output but you'll be promoting creosote build-up. Again, it will take a few days practice to achieve the desired setting.

Fan Maintenance--

You should remove your fan from the unit at least twice a year for cleaning. Dust will accumulate on the fan cover as well as the fan motor and impellers. These parts should be cleaned to insure adequate flow of air and minimize strain on the motor. At this time the motor, front fan only, can be lubricated using a light gauge machine oil (i.e. sewing machine oil).

Stove Maintenance--

It is highly recommended that you periodically lubricate any moving parts such as the door hinges, draft, damper and start-up control rods. This will eliminate any scraping or squeaking noises as well as allow the parts to move more freely. A high temperature lubricant (i.e. Permatex Industrial (R) anit-seize lubricant) is required for this. Graphite or low temperature lubricants will only last for a few days.

Stove Maintenance (continued)--

At the end of each heating season, remove all ashes from your stove. With a wire brush remove any scale on the inside of the firebox. Replace any broken firebrick, worn glass, and door gasketing material. The exterior of the stove can be touched up using high temperature "Forrest Stove-Brite" paint, available at your dealer. To touch up paint, first sand the area to be painted with 120 grit sandpaper, clean with water only and dry with a clean cloth. Paint using a "light" covering coat. The area painted may appear darker until the paint has gone through the curing process.

Ash Disposal--

During constant periods of use, such as in the cold winter months, ashes must be periodically removed from the stove's firebox to prevent a build-up which will affect the performance of the appliance and limit the fuel load capacity.

Ashes should be placed in a metal container with a tight fitting lid. The closed container of ashes should be placed on a non-combustible floor or on the ground, well away from all combustible materials, pending final disposal. If the ashes are disposed of by burial in soil or otherwise locally dispersed, they should be retained in the closed container until all cinders have thoroughly cooled. Other waste must not be placed in this container.

Brass--

Your Avalon stove may come with solid brass door and trim which will require periodical attention to retain its luster. Use a non-abrasive polish when polishing your brass and clean the door when it is cool. A suitable non-abrasive polish is available at your dealer.

Glass--

Clean glass in door only when glass is cool, and use a non-abrasive cleaner. If glass should happen to be cracked or broken, wait until it has cooled before attempting to remove it. Do not operate unit with broken glass or without glass at all.

To replace glass, simply remove the glass retainers on back of door by removing the screws. Replace broken glass with Neoceram 5mm thick, provided by your Avalon dealer or call Avalon directly for assistance.

Do not use substitute glass. Remember, glass must be wrapped on edges with fiberglass gasketing available at your Avalon dealer. Gaskets to be used are 7 $\frac{1}{8}$ " fiberglass weave for the 700, 901 and 1000 door. Glass gaskets to be used are 3 $\frac{1}{8}$ " fiberglass weave for the 700 and 5 $\frac{1}{16}$ " fiberglass weave for the 901 and 1000. Make sure when replacing glass or door gasketing that glass clips have 3 $\frac{1}{4}$ " self-adhesive channel tape on them before tightening screws.

PLEASE SAVE THESE INSTRUCTIONS FOR FUTURE REFERENCE. THANK YOU FOR CHOOSING AVALON. YOU'LL BE GLAD YOU DID FOR MANY, MANY YEARS!

MODEL 700 MODEL 901

CONTACT YOUR LOCAL BUILDING OR FIRE OFFICIALS ABOUT RESTRICTIONS AND INSTALLATION INSPECTION IN YOUR AREA

Listed Factory-Built Fireplace Accessory/Insert/Earth Mount, Masonry Fireplace Accessory/Insert/Earth Mount, Solid Fuel Type Room Heaters. Also Suitable for Alcove Installation. Also Suitable for Mobile Home Installation Pursuant to (UM)4-IUD

AVALON

Tested & Listed by **UL** Beaverton, OR, USA
ICBO No. IL-130

SERIAL NO. [REDACTED]

"PREVENT HOUSE FIRES"

Install and use only in accordance with manufacturer's installation and operating instructions and your local building codes. CAUTION: Special methods are required when passing chimney through a wall or ceiling, refer to local building codes. DO NOT pass chimney connector through a combustible surface. DO NOT connect this unit to a chimney flue serving another appliance.

COMPONENTS REQUIRED: When used as a residential masonry fireplace insert, install with Part No. P.L.S.

MODEL: 700
TESTED TO: UL 127/UL 207/UL 1482
TEST DATE: May 20, 1987
REPORT NO. 98-110-4
ICBO NO. IL-130
TYPE OF FUEL: Solid Wood Only
WARNING: (MOBILE HOME) An outside air inlet must be provided for combustion, and be unrestricted while unit is in use. Do not install appliance in a sleeping room. The structural integrity of the mobile home floor, walls and ceiling/hood must be maintained.
NOTE: Replace glass only with 5mm Neoceram.

Install insert with a minimum of 14" clearance to combustible sidewall, 10" to side and 28" (18" for zero clearance) to top trim, 28" (18" for zero clearance) from top of insert to mantel. Floor protector must be 3/8" minimum non-combustible material or equivalent, extending 18" in front of hearth and 4" to both sides. When used as an insert stove, install only in a masonry fireplace, built to USC Chapter 37. Do not remove brick or mortar from masonry fireplace to accommodate insert. Use flue outlet with a direct connector. Remove and clean behind unit frequently, as creosote buildup may occur rapidly.

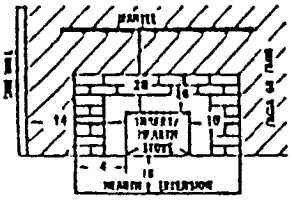

Minimum Clearances to Combustible Materials (in inches).

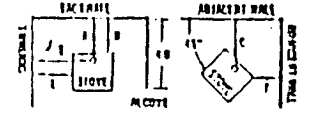

Floor protector must be 3/8" min. thickness non-combustible material or equivalent, extending beneath hearth and to the front/rear as indicated.

Installation	Clearance	Chimney & Connector	Dimensions					
			A	B	C	D	E	F
Residential Standard	Standard	Note 1	18	10 1/4	18	21	18	18
Residential Reduced	Reduced	Note 2	18	10	17	19	18	18
Mobile Home Standard	Standard	Note 2,3	18	10	17	19	18	18
Alcove Standard	Standard	Note 2,3,4	18	10	N/A	19	18	N/A

- Note 1: 8 inch diameter, single wall, minimum 24 MBQ black or 28 MBQ blue steel connector pipe with listed factory-built chimney suitable for use with solid fuels or masonry chimney.
- Note 2: 8 inch diameter L-Vent connector pipe with listed factory-built Class "A" chimney. (Mobile Home must be equipped with a spark arrester.)
- Note 3: See manual for mobile home pipe and chimney systems.
- Note 4: Minimum alcove size: 7 ft. high, 48 in. wide, and 4 ft. max. depth.



CAUTION: NOT WHILE IN OPERATION. DO NOT TOUCH CONTACT MAY CAUSE SKIN BURNS. KEEP FURNISHINGS AND COMBUSTIBLE MATERIALS A CONSIDERABLE DISTANCE AWAY. SEE NAMEPLATE AND INSTRUCTIONS. DO NOT OVERTIRE. IF HEATER OR CHIMNEY CONNECTOR GLOWS, YOU ARE OVERTIRING. INSPECT AND CLEAN CHIMNEY AND CONNECTOR FREQUENTLY. UNDER CERTAIN CONDITIONS OF USE, CREOSOTE BUILDUP MAY OCCUR RAPIDLY. DO NOT USE GRATE OR ELEVATE FIRE—BUILD WOOD FIRE DIRECTLY ON HEARTH. FEED DOOR MUST BE CLOSED DURING FIRING EXCEPT WHEN ADDING FUEL.

Made in U.S.A. DO NOT REMOVE THIS LABEL

CONTACT YOUR LOCAL BUILDING OR FIRE OFFICIALS ABOUT RESTRICTIONS AND INSTALLATION INSPECTION IN YOUR AREA

Listed Factory-Built Fireplace Accessory/Insert/Earth Mount; Masonry Fireplace Accessory/Insert/Earth Mount, Solid Fuel Type Room Heaters. Also Suitable for Mobile Home Installation Pursuant to (UM)4-IUD

AVALON

Tested & Listed by **UL** Beaverton, OR, USA
ICBO No. IL-130

SERIAL NO. [REDACTED]

"PREVENT HOUSE FIRES"

Install and use only in accordance with manufacturer's installation instructions and your local building codes. CAUTION: Special methods are required when passing chimney through a wall or ceiling, refer to local building codes. DO NOT pass chimney connector through a combustible surface. DO NOT connect this unit to a chimney flue serving another appliance.

WARNING: (MOBILE HOME) An outside air inlet must be provided for combustion, and unrestricted while unit is in use. Do not install appliance in a sleeping room. The structural integrity of the mobile home floor, walls and ceiling/hood must be maintained.

MODELS: 1000 C2, 901 FLUSH, 1000 C2 FLUSH
TESTED TO: UL 127, UL 207, UL 1482
TEST DATE: July 9, 1987
REPORT NO. 85-110-11
TYPE OF FUEL: Solid Wood Only

Catalytic combustor: Honeycomb (Part No. AV 99). Burning of metal oils, coal, plastic, garbage, rubber and diesel oil will make the catalyst in the converter inactive. The converter is fragile, handle carefully. The performance of the catalytic combustor or its durability has not been evaluated as part of the certification.

NOTE: Replace glass only with 5mm ceramic or Neoceram.

Install insert hearth stove with a minimum of 11" clearance to combustible sidewall, 7" to side and 18" to top trim, 27" from top of insert to mantel. Floor protector must be 3/8" minimum non-combustible material or equivalent, extending 18" in front of hearth and 4 1/2" to both sides. When used as an insert stove, install only in a masonry fireplace, built to USC Chapter 37 or a Listed Zero-Clearance Fireplace (see manual). Do not remove brick or mortar from masonry fireplace to accommodate insert. Use flue outlet with a direct connector. Remove and clean behind unit frequently, as creosote buildup may occur rapidly.

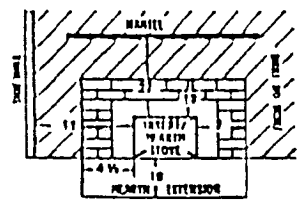

Minimum Clearances to Combustible Materials (in inches).

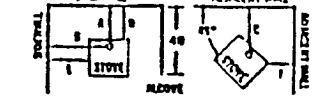

Floor protector must be 3/8" min. thickness non-combustible material or equivalent, extending beneath hearth and to the front/rear as indicated.

Type of Installation	Chimney & Connector	Dimensions					
		A	B	C	D	E	F
Backdraft w/o side panels or flush	Note 1,2	11	10	18	17 1/4	18	18
Backdraft w/ side panels w/ side panels or flush	Note 1,2	1	10	18	19	18	18
Backdraft w/ side panels w/o side panels	Note 1,2	1	10	18	19	18	18
Alcove with side panels or flush	Note 1,2,4	1	10	18	19	18	N/A

- Note 1: 8 inch diameter, single wall, minimum 24 MBQ black or 28 MBQ blue steel connector pipe with listed factory-built chimney suitable for use with solid fuels or masonry chimney.
- Note 2: 8 inch diameter L-Vent pipe with listed factory-built chimney suitable for use with solid fuels or a masonry chimney. (Mobile Home must be equipped with a spark arrester. See manual for mobile home pipe and chimney systems.)
- Note 3: Model 901 or 1000 C2 require side panels (Part No. AVX 390) for alcove installation only.
- Note 4: Alcove size: Min. 7 ft. height, min. 48 in. width and max. 48 in. depth.



CAUTION: NOT WHILE IN OPERATION. DO NOT TOUCH CONTACT MAY CAUSE SKIN BURNS. KEEP FURNISHINGS AND COMBUSTIBLE MATERIALS A CONSIDERABLE DISTANCE AWAY. SEE NAMEPLATE & INSTRUCTIONS. DO NOT OVERTIRE. IF HEATER OR CHIMNEY CONNECTOR GLOWS, YOU ARE OVERTIRING. INSPECT AND CLEAN CHIMNEY AND CONNECTOR FREQUENTLY. UNDER CERTAIN CONDITIONS OF USE, CREOSOTE BUILDUP MAY OCCUR RAPIDLY. DO NOT USE GRATE OR ELEVATE FIRE—BUILD WOOD FIRE DIRECTLY ON HEARTH. DO NOT BURN WITH FEED DOOR OPEN. FEED DOOR MUST BE CLOSED DURING FIRING EXCEPT WHEN ADDING FUEL.

Made in U.S.A. DO NOT REMOVE THIS LABEL

(CATALYTIC)
1000 C2